

Wildlife Bunkie 40 (139" x 112 3/16")

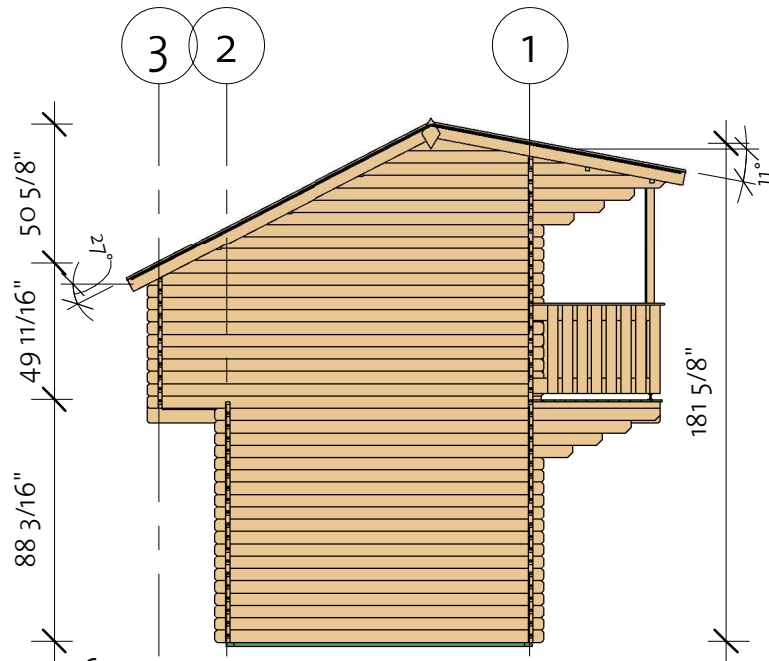
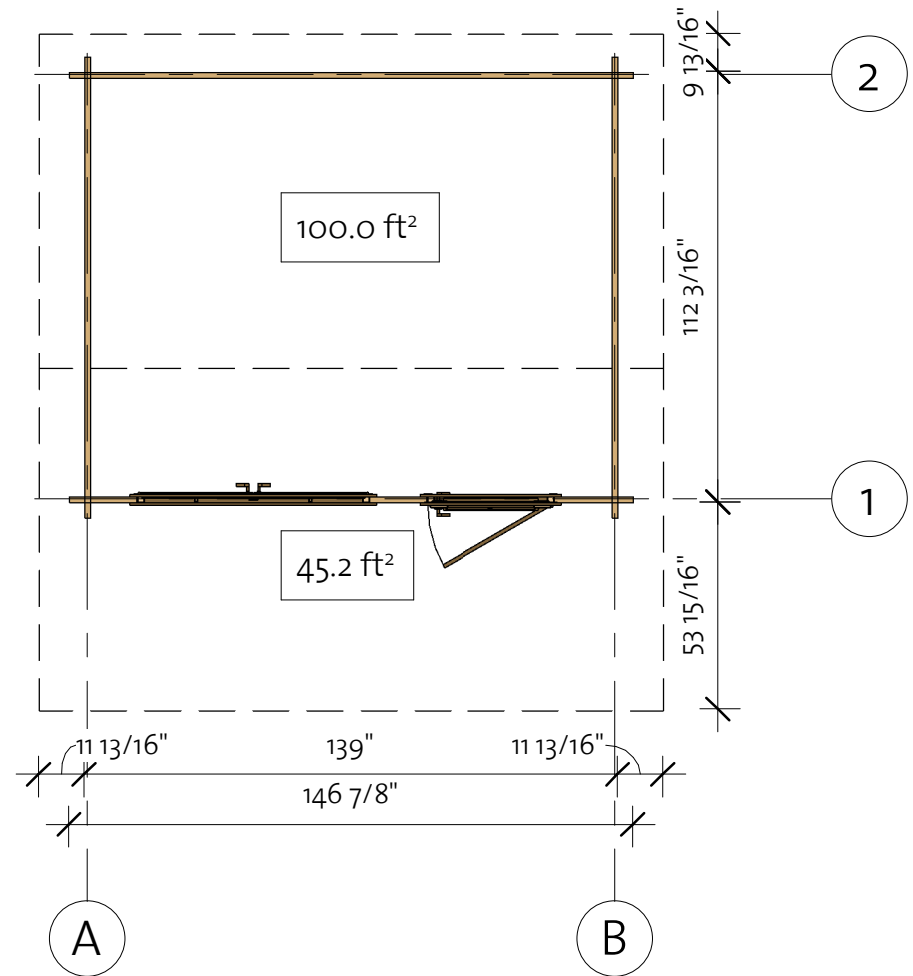

92202041_220316

Wildlife Bunkie 40 (139" x 112 3/16")

Foundation

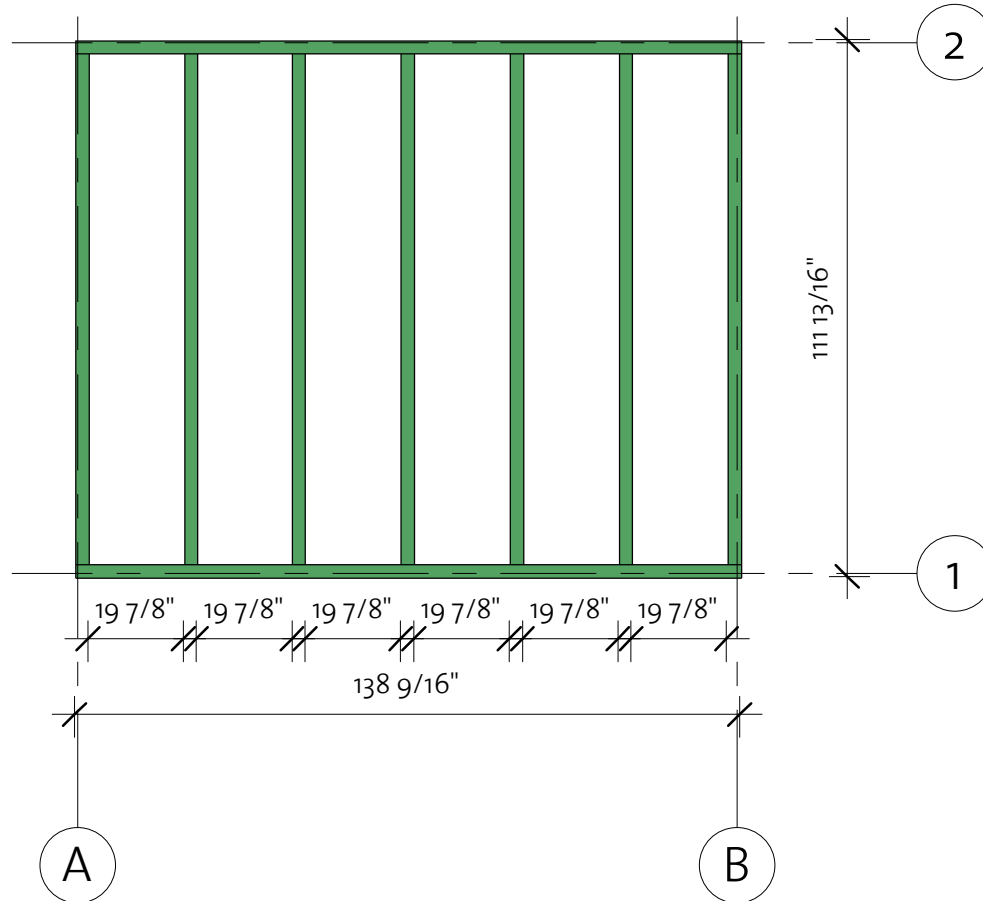

Impregnated foundation beams				
Mark	Type	Profile	Count	Length
IFB1	IFB 70x40		2	138 9/16"
IFB2	IFB 70x40		7	106 5/16"

Wildlife Bunkie 40 (139" x 112 3/16")

Floor Plan

① Baseboard

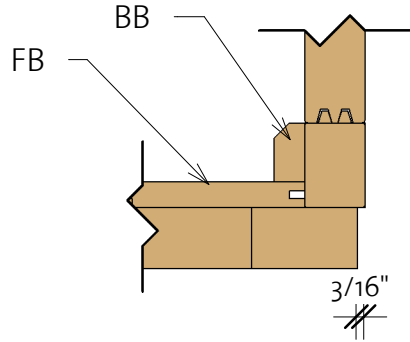

Floor Schedule				
Mark	Type	Profile	Count	Length

FB1	FB 17x114		25	135 9/16"
-----	-----------	---	----	-----------

BB1	BB 20x40		6	141 3/4"
BB2	BB 20x40		2	114 3/16"

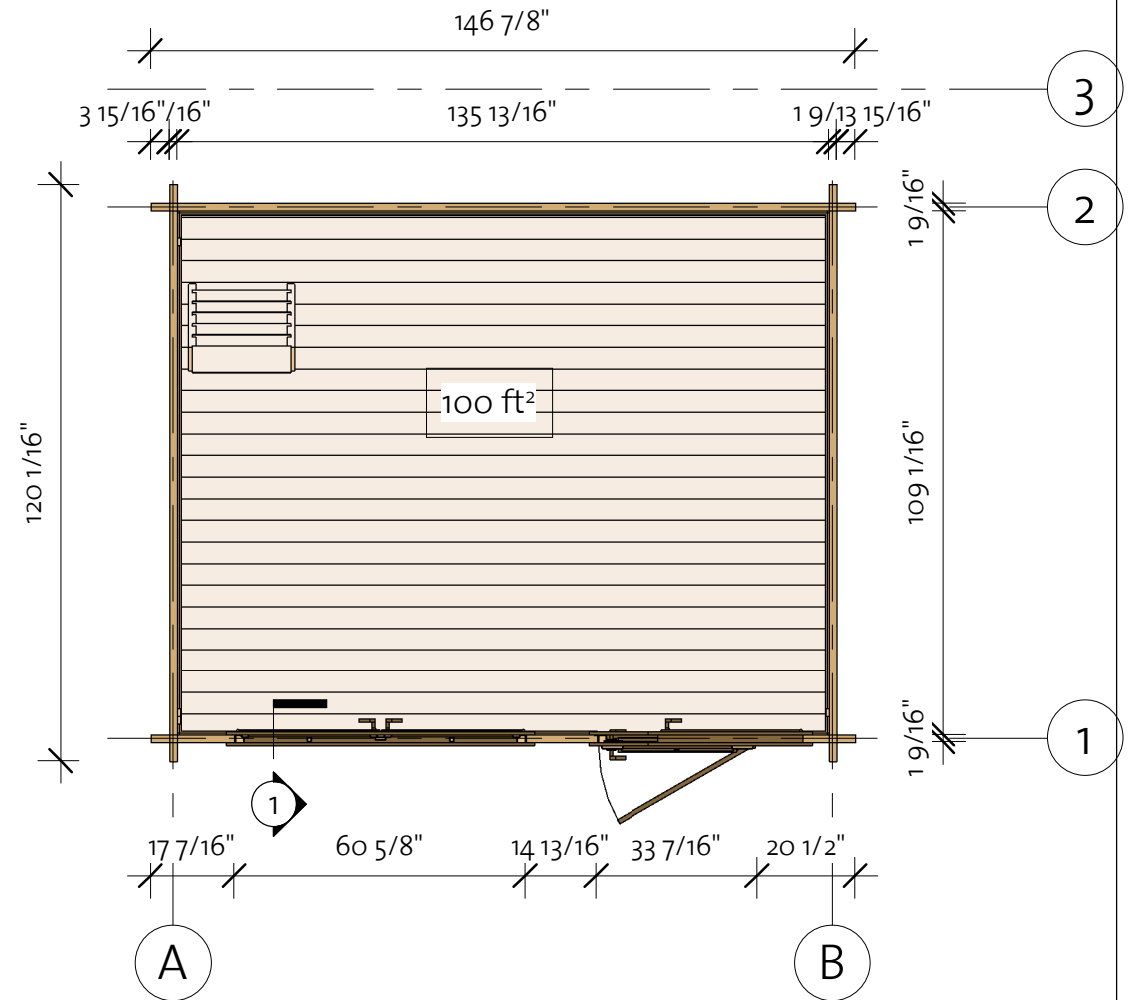

92202041_220316

Wildlife Bunkie 40 (139" x 112 3/16")

Wall 1

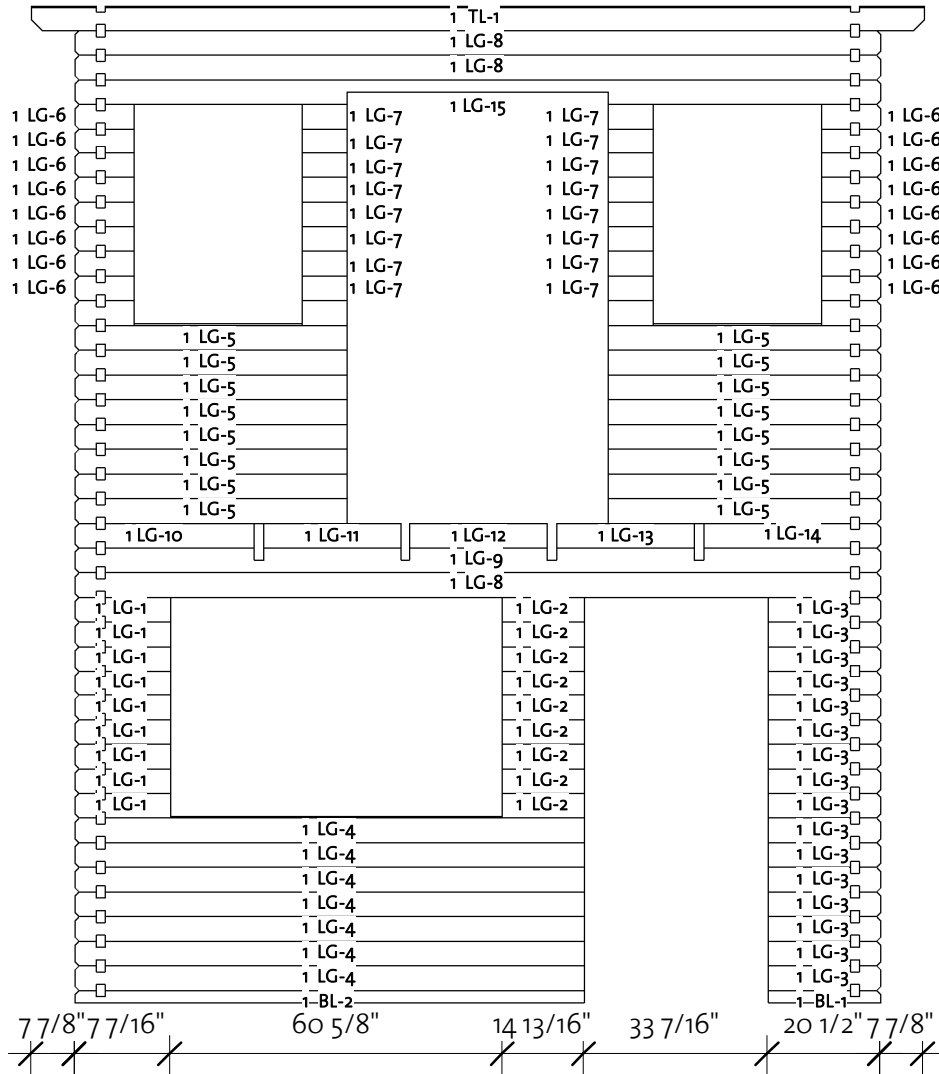
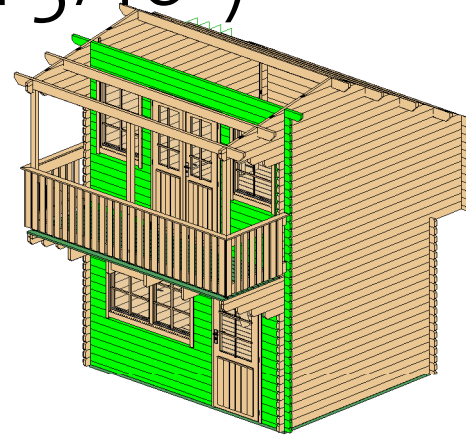

Wall 1			
Mark	Profile	Count	Cut Length

1BL-1	40X57	1	20 1/2"
1BL-2	40X57	1	92 15/16"
1LG-1	40X114	9	17 7/16"
1LG-2	40X114	9	14 13/16"
1LG-3	40X114	16	20 1/2"
1LG-4	40X114	7	92 15/16"
1LG-5	40X114	16	49 1/2"
1LG-6	40X114	18	10 13/16"
1LG-7	40X114	18	8 3/16"
1LG-8	40X114	3	146 7/8"
1LG-9	40X114	1	146 7/8"
1LG-10	40X114	1	32 5/8"
1LG-11	40X114	1	25"
1LG-12	40X114	1	25"
1LG-13	40X114	1	25"
1LG-14	40X114	1	32 3/16"
1LG-15	40X114	1	146 7/8"
1TL-1	40X114	1	162 5/8"

Log Profile Wall 1	
Profile	Profile

40X57	
40X114	
40X114	
40X114	

Wildlife Bunkie 40 (139" x 112 3/16")

Wall 2

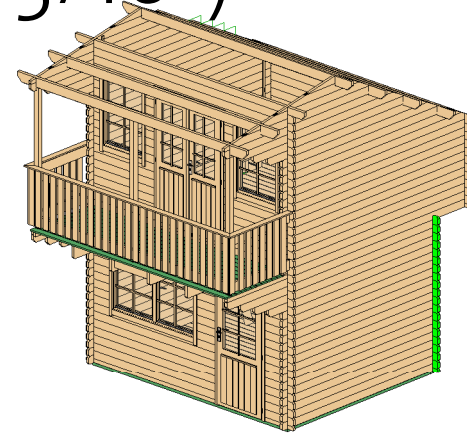

Wall 2			
Mark	Profile	Count	Cut Length

2BL-1	40X57	1	146 7/8"
2LG-1	40X114	17	146 7/8"
2LG-2	40X114	1	32 5/8"
2LG-3	40X114	3	25"
2LG-4	40X114	1	32 3/16"
2LG-5	40X114	1	146 7/8"

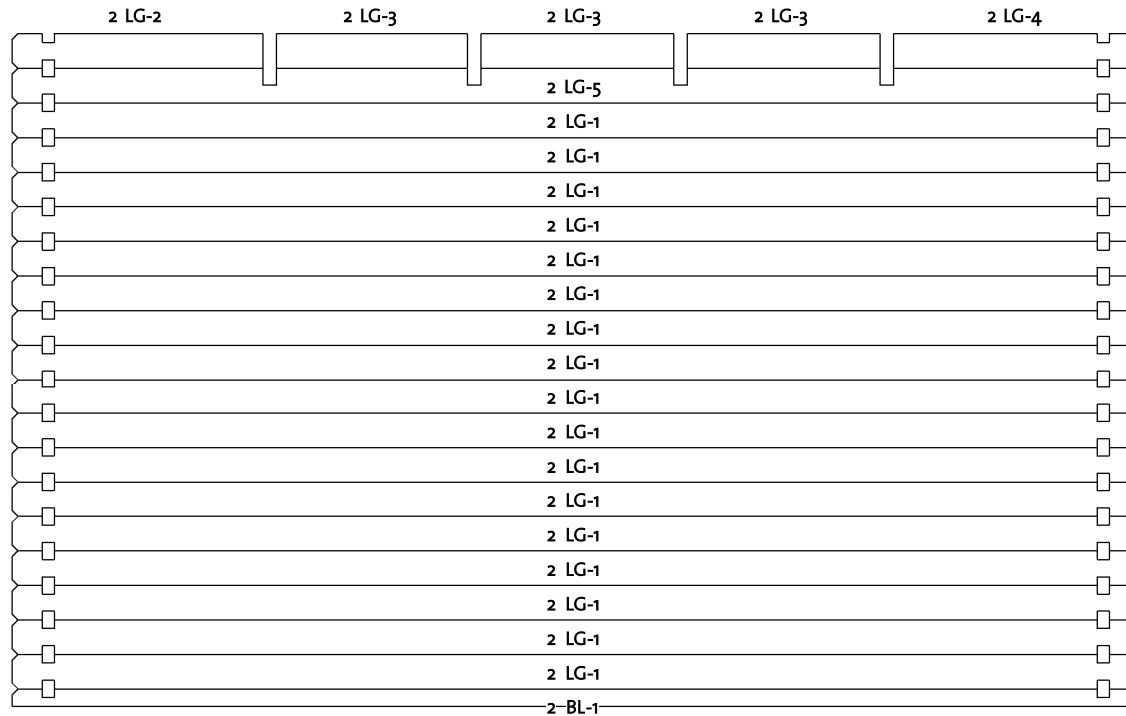

Log Profile Wall 2	
Profile	Profile

40X57	
40X114	
40X114	

Wildlife Bunkie 40 (139" x 112 3/16")

Wall 3

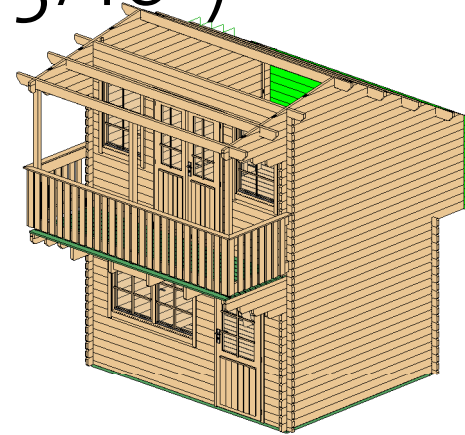

Wall 3			
Mark	Profile	Count	Cut Length

3BL-1	40X57	1	146 7/8"
3LG-1	40X114	10	146 7/8"
3TL-1	40X139	1	162 5/8"

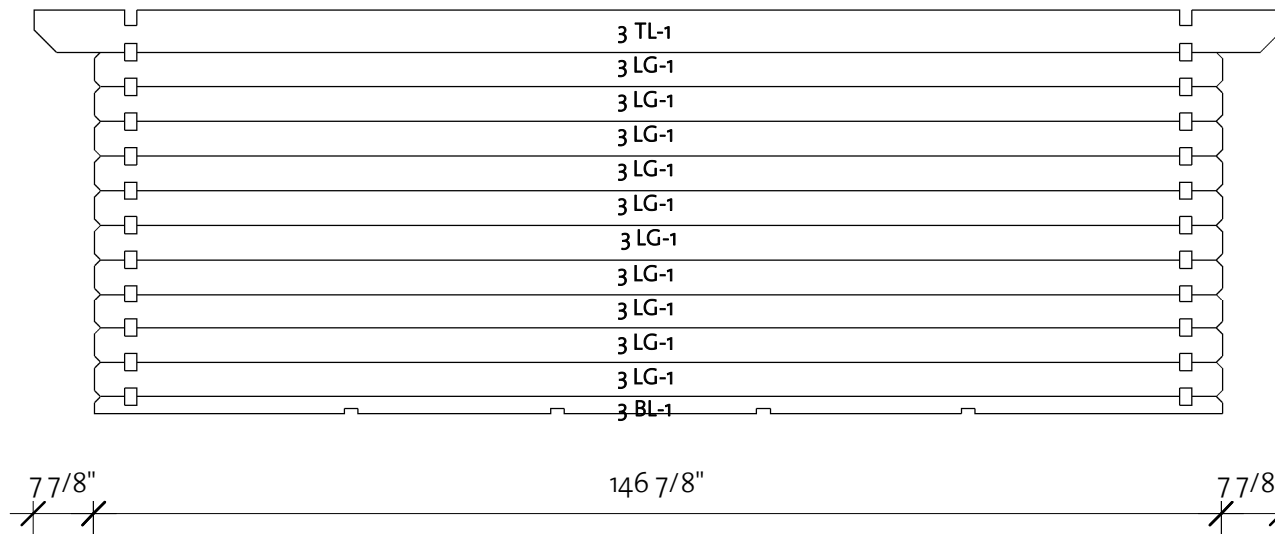

Log Profile Wall 3	
Profile	Profile

40X57	
40X114	
40X139	

Wildlife Bunkie 40 (139" x 112 3/16")

Wall A

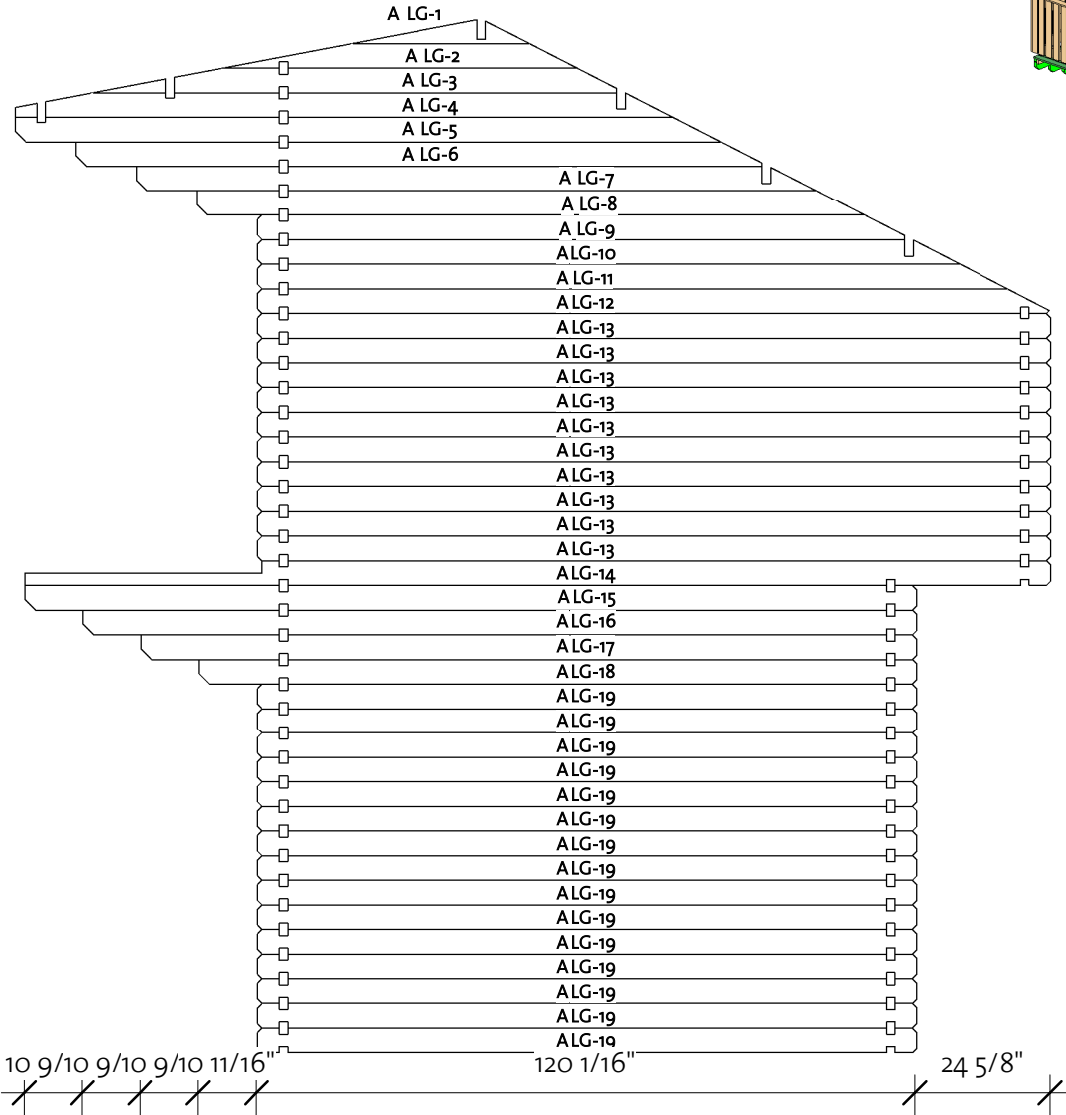
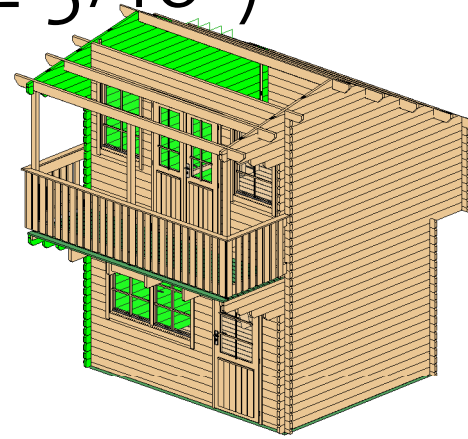

Wall A			
Mark	Profile	Count	Cut Length
ALG-1 *	4OX114	1	32 5/16"
ALG-2 *	4OX114	1	64 11/16"
ALG-3 *	4OX114	1	95 1/2"
ALG-4 *	4OX114	1	119 7/8"
ALG-5 *	4OX114	1	128 9/16"
ALG-6 *	4OX114	1	125"
ALG-7 *	4OX114	1	123 15/16"
ALG-8 *	4OX114	1	121 5/8"
ALG-9 *	4OX114	1	117 7/8"
ALG-10 *	4OX114	1	128"
ALG-11 *	4OX114	1	136 3/4"
ALG-12 *	4OX114	1	144 7/16"
ALG-13	4OX114	10	144 11/16"
ALG-14	4OX114	1	187"
ALG-15	4OX114	1	162 3/8"
ALG-16	4OX114	1	151 7/8"
ALG-17	4OX114	1	141 5/16"
ALG-18	4OX114	1	130 3/4"
ALG-19	4OX114	15	120 1/16"

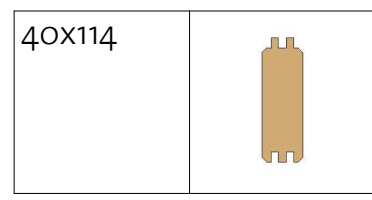
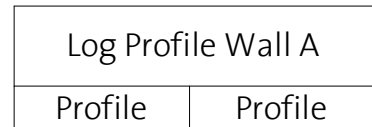

* Gable - delivered premounted

92202041_220316

Wildlife Bunkie 40 (139" x 112 3/16")

Wall B

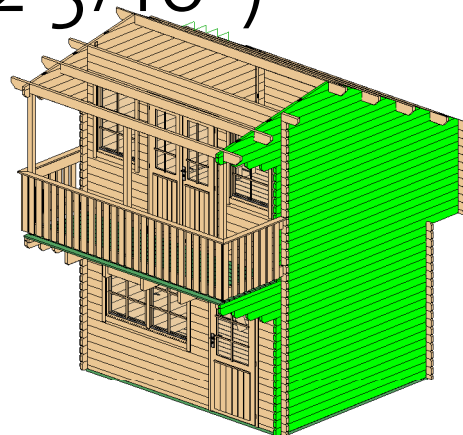
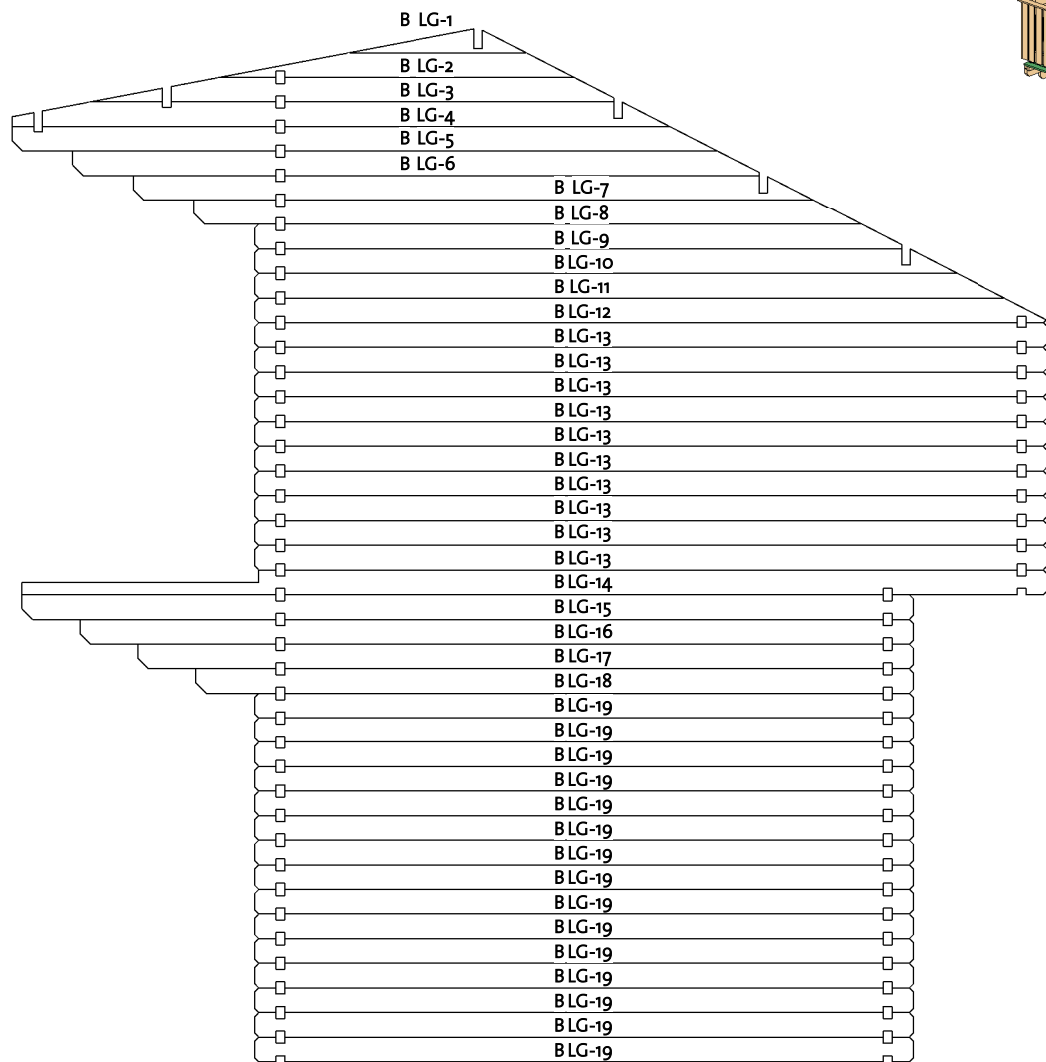

Wall B

Mark	Profile	Count	Cut Length
------	---------	-------	------------

BLG-1 *	40X114	1	32 5/16"
BLG-2 *	40X114	1	64 11/16"
BLG-3 *	40X114	1	95 1/2"
BLG-4 *	40X114	1	119 7/8"
BLG-5 *	40X114	1	128 9/16"
BLG-6 *	40X114	1	125"
BLG-7 *	40X114	1	123 15/16"
BLG-8 *	40X114	1	121 5/8"
BLG-9 *	40X114	1	117 7/8"
BLG-10 *	40X114	1	128"
BLG-11 *	40X114	1	136 3/4"
BLG-12 *	40X114	1	144 7/16"
BLG-13	40X114	10	144 11/16"
BLG-14	40X114	1	187"
BLG-15	40X114	1	162 3/8"
BLG-16	40X114	1	151 7/8"
BLG-17	40X114	1	141 5/16"
BLG-18	40X114	1	130 3/4"
BLG-19	40X114	15	120 1/16"

Log Profile Wall B

Profile	Profile
---------	---------

40X114



* Gable - delivered premounted

10 9/10 9/10 9/10 11/16"

120 1/16"

24 5/8"

92202041_220316

Wildlife Bunkie 40 (139"x112 3/16")

Second floor 1

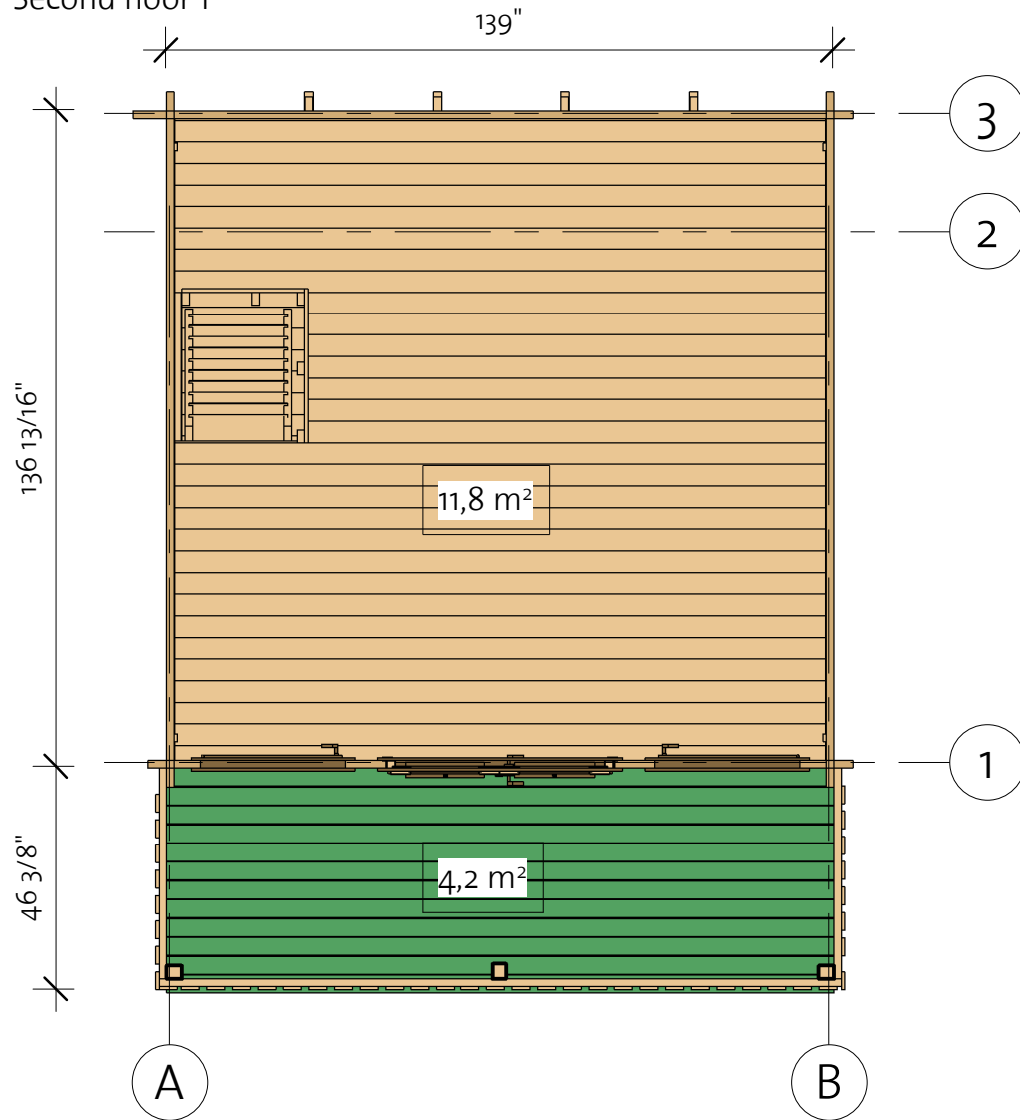

Second Floor Schedule				
Mark	Type	Profile	Count	Length

FB2	FB 17x114		24	135 9/16"
FB3	FB 17x114		7	108 9/16"
TB	TB 21x95		13	139"

Wildlife Bunkie 40 (139" x 112 3/16")

Second floor 2

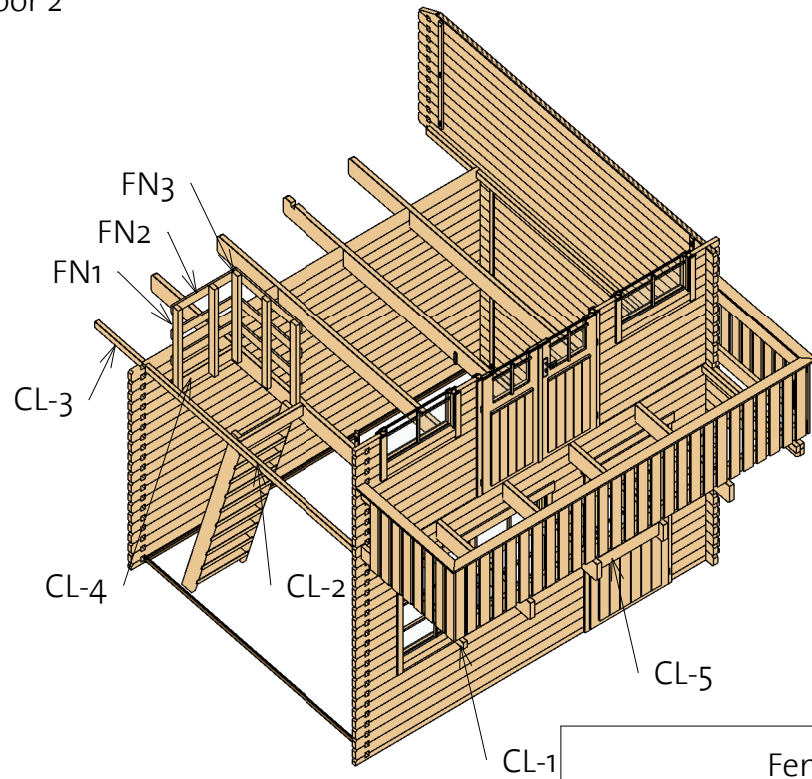

Fence schedule				
Mark	Type	Profile	Count	Length

FN1	Fence 40x70		5	39 3/8"
FN2	Fence 18x95		3	25 9/16"

Second floor 2				
Mark	Type	Profile	Count	Length

CL-1	Ceiling beam 40x70		2	46 1/4"
CL-2	Ceiling beam 40x70		2	109 1/16"
CL-3	Ceiling beam 40x70		2	23 1/16"
CL-4	Ceiling beam 40x120		2	25 9/16"
CL-5	Ceiling beam 40x143		2	25"



Fence schedule				
Mark	Type	Profile	Count	Length

FN3	Fence 18x95		3	32 3/16"
-----	----------------	--	---	----------

Wildlife Bunkie 40 (139" x 112 3/16")

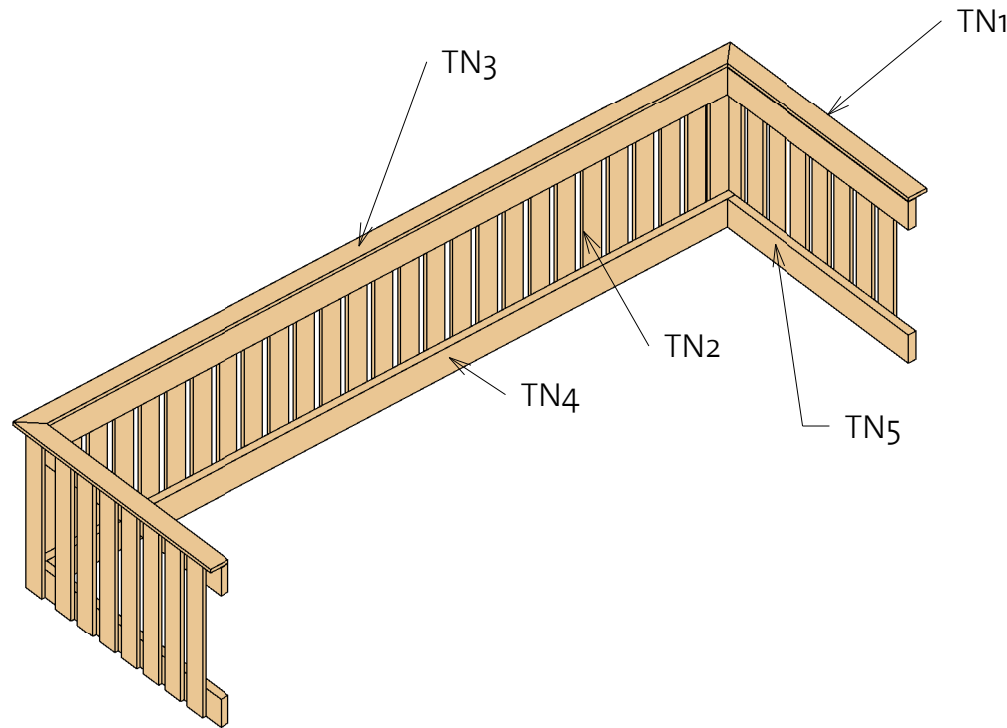
Terrace Fence



Terrace Fence				
Mark	Profile	Profile	Count	Length
TN1	Fence 18x95		2	47 13/16"
TN2	Fence 18x95		43	32 3/8"
TN3	Fence 18x95		1	146 7/16"
TN4	Fence 40x143		2	142 1/4"
TN5	Fence 40x143		4	44 1/8"

Wildlife Bunkie 40 (139"x112 3/16")

Roof 1

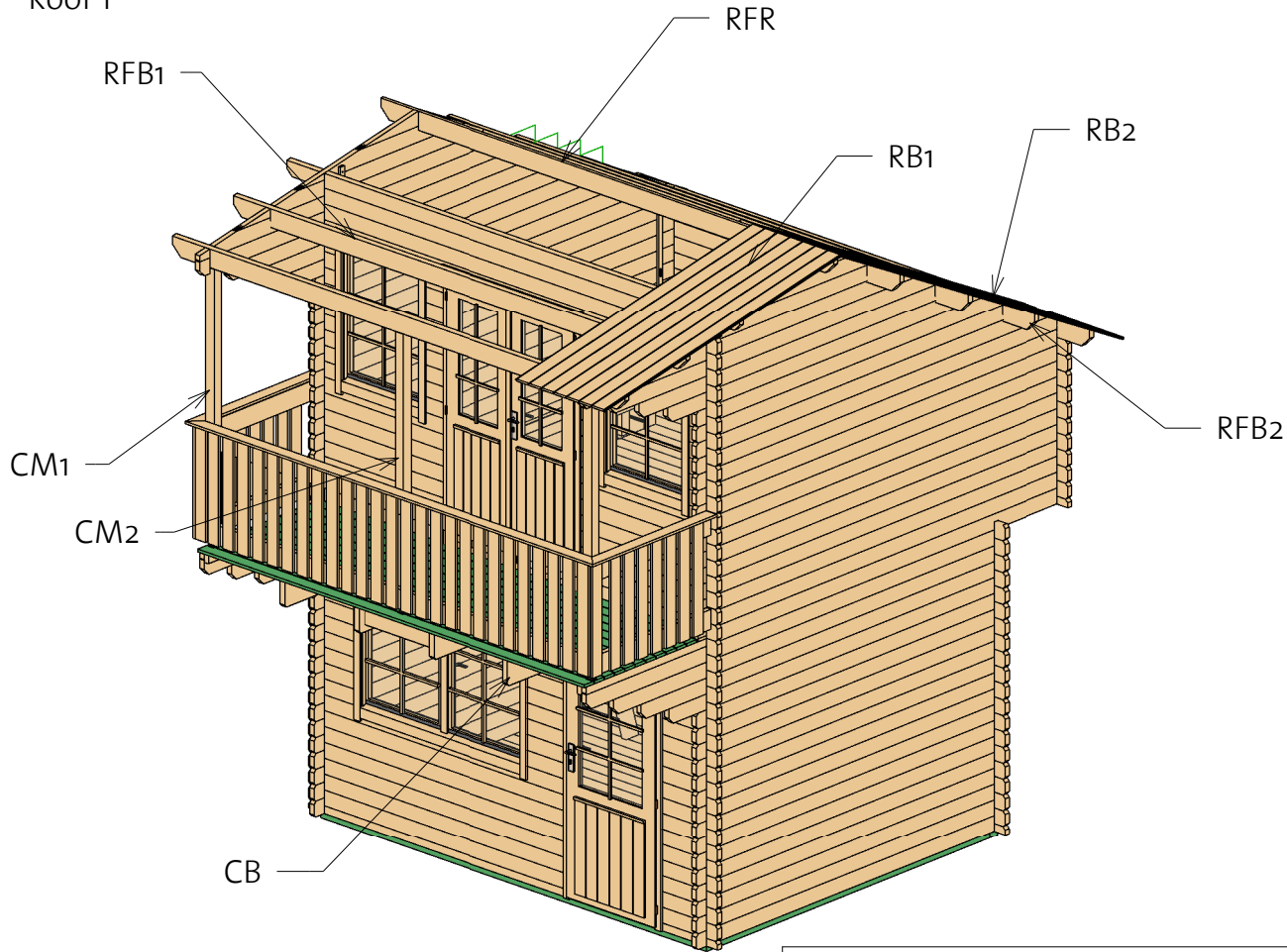

Roof				
Mark	Type	Profile	Count	Length

RB1	17x114		38	92 7/16"
RB2	17x114		38	122 15/16"
RFB1	Beam 40x143		2	162 5/8"
RFB2	Beam 40x143		3	162 5/8"
RFR	Ridge 40x143		1	162 5/8"

Ceiling Beams

Mark	Type	Profile	Count	Length
------	------	---------	-------	--------

CB	Ceiling beam 45x195		4	187"
----	---------------------	--	---	------

Columns

Mark	Profile	Count	Length
------	---------	-------	--------

CM1	Post 80x70	2	77 1/16"
CM2	Post 80x70	1	79 5/16"

Wildlife Bunkie 40 (139" x 112 3/16")

Roof 2

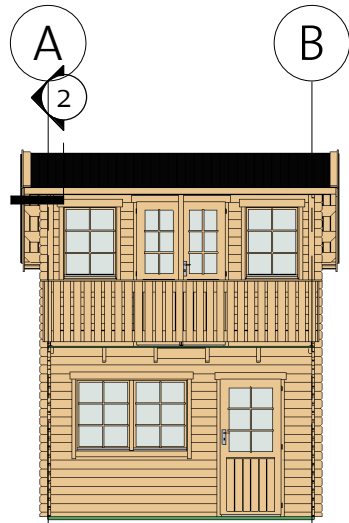

② Roof Reinforcement

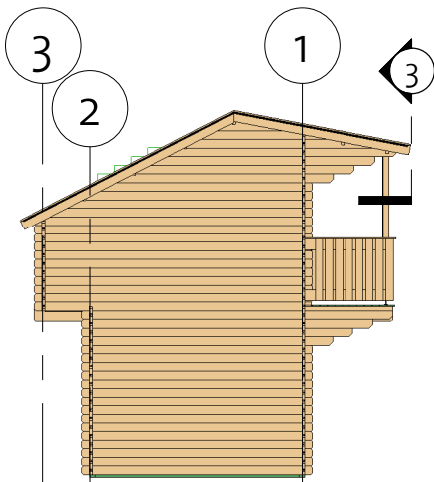
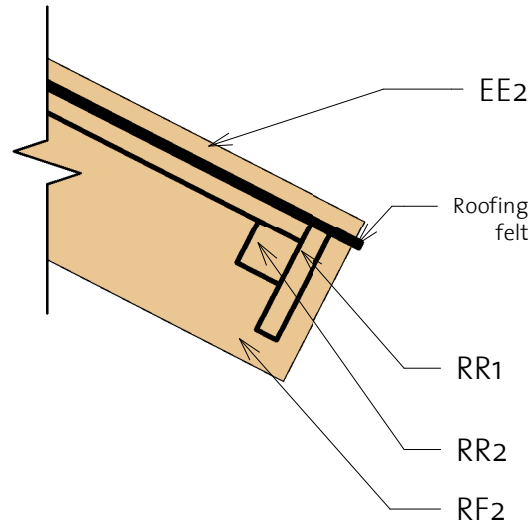

③ Facia

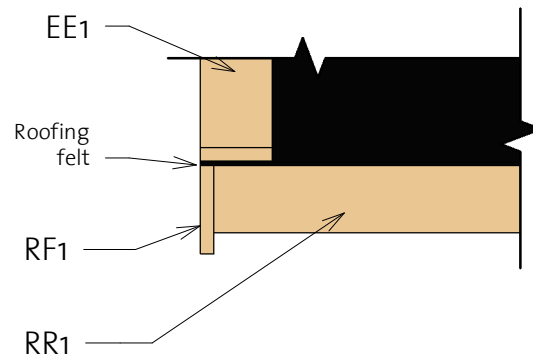

Fascia Schedule

Mark	Type	Profile	Count	Length
EE1	Eave Edging 18x95		2	94 1/16"
EE2	Eave Edging 18x95		2	124 13/16"
RF1	Roof Fascia 18x120		2	94 1/16"
RF2	Roof Fascia 18x120		2	124 13/16"
RR1	Roof reinforcement 18x95		2	162 5/8"
RR2	Roof reinforcement 38x38		2	162 5/8"

Wildlife Bunkie 40 (139" x 112 3/16")

Extras



Door Schedule				
Model	Type	Width	Height	Count
CD9R	Classic door 9 right	33 1/16"	72 1/4"	1
CDD5R	Classic double door 5 right	47 1/4"	76 15/16"	1
DCB6	Door Crossbar 6	--	--	1/16"
DCB6-1	Door Crissbar 6-1			1/16"

Fasteners/Extras		
Name	Type	Count

Hitblock	300-400 mm	
Adjustable post foot		3
Bolts	M8 x 70	16
Screws	6,0 x 140	65
Nails	1,4 x 40	65
Screws	5,0 x 70	120
Screws	4,0 x 40	1200

Window Schedule				
Mark	Type	Width	Height	Count
DB	Door beam 1215 mm	40	12	1
CDW1	Classic double window 1	60 1/4"	39"	1
CW1L	Classic window 1 left	30 1/8"	39"	1
CW1R	Classic window 1 right	30 1/8"	39"	1
WCB6	Windows Crossbar 6	--	--	6

Type	Count
------	-------

Windboard 18x40 2300	2
Windboard 18x40x1200	2
Windboard 18x40x2200	4

Type	Count
------	-------

Romb	2
------	---

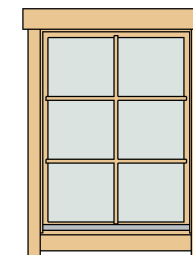
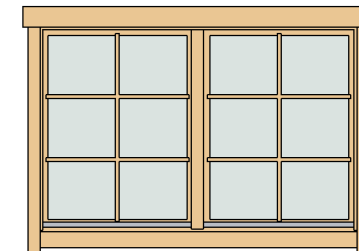
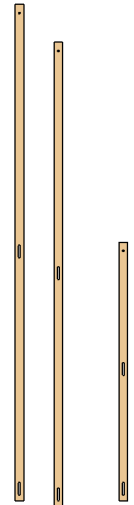

Wildlife Bunkie 40 (139"x112 3/16")

List of all items 1







Impregnated foundation beams				
Mark	Type	Profile	Count	Length

IFB1	IFB 70x40		2	138 9/16"
IFB2	IFB 70x40		7	106 5/16"

Floor Schedule				
Mark	Type	Profile	Count	Length





FB1	FB 17x114		25	135 9/16"
-----	-----------	---	----	--------------

Fascia Schedule				
Mark	Type	Profile	Count	Length

EE1	Eave Edging 18x95		2	94 1/16"
EE2	Eave Edging 18x95		2	124 13/16"
RF1	Roof Fascia 18x120		2	94 1/16"
RF2	Roof Fascia 18x120		2	124 13/16"
RR1	Roof reinforce ment 18x95		2	162 5/8"
RR2	Roof reinforce ment 38x38		2	162 5/8"

BB1	BB 20x40		6	141 3/4"
BB2	BB 20x40		2	114 3/16"

Roof				
Mark	Type	Profile	Count	Length

RB1	17x114		38	92 7/16"
RB2	17x114		38	122 15/16"
RFB1	Beam 40x143		2	162 5/8"
RFB2	Beam 40x143		3	162 5/8"
RFR	Ridge 40x143		1	162 5/8"

Wildlife Bunkie 40 (139"x112 3/16")

List of all items 2

Wall A			
Mark	Profile	Count	Cut Length

ALG-1 *	40X114	1	32 5/16"
ALG-2 *	40X114	1	64 11/16"
ALG-3 *	40X114	1	95 1/2"
ALG-4 *	40X114	1	119 7/8"
ALG-5 *	40X114	1	128 9/16"
ALG-6 *	40X114	1	125"
ALG-7 *	40X114	1	123 15/16"
ALG-8 *	40X114	1	121 5/8"
ALG-9 *	40X114	1	117 7/8"
ALG-10 *	40X114	1	128"
ALG-11 *	40X114	1	136 3/4"
ALG-12 *	40X114	1	144 7/16"
ALG-13	40X114	10	144 11/16"
ALG-14	40X114	1	187"
ALG-15	40X114	1	162 3/8"
ALG-16	40X114	1	151 7/8"
ALG-17	40X114	1	141 5/16"
ALG-18	40X114	1	130 3/4"
ALG-19	40X114	15	120 1/16"

Wall B			
Mark	Profile	Count	Cut Length

BLG-1 *	40X114	1	32 5/16"
BLG-2 *	40X114	1	64 11/16"
BLG-3 *	40X114	1	95 1/2"
BLG-4 *	40X114	1	119 7/8"
BLG-5 *	40X114	1	128 9/16"
BLG-6 *	40X114	1	125"
BLG-7 *	40X114	1	123 15/16"
BLG-8 *	40X114	1	121 5/8"
BLG-9 *	40X114	1	117 7/8"
BLG-10 *	40X114	1	128"
BLG-11 *	40X114	1	136 3/4"
BLG-12 *	40X114	1	144 7/16"
BLG-13	40X114	10	144 11/16"
BLG-14	40X114	1	187"
BLG-15	40X114	1	162 3/8"
BLG-16	40X114	1	151 7/8"
BLG-17	40X114	1	141 5/16"
BLG-18	40X114	1	130 3/4"
BLG-19	40X114	15	120 1/16"

* Gable - delivered premounted

Wildlife Bunkie 40 (139"x112 3/16")

List of all items 3

Wall 1			
Mark	Profile	Count	Cut Length

1BL-1	40X57	1	20 1/2"
1BL-2	40X57	1	92 15/16"
1LG-1	40X114	9	17 7/16"
1LG-2	40X114	9	14 13/16"
1LG-3	40X114	16	20 1/2"
1LG-4	40X114	7	92 15/16"
1LG-5	40X114	16	49 1/2"
1LG-6	40X114	18	10 13/16"
1LG-7	40X114	18	8 3/16"
1LG-8	40X114	3	146 7/8"
1LG-9	40X114	1	146 7/8"
1LG-10	40X114	1	32 5/8"
1LG-11	40X114	1	25"
1LG-12	40X114	1	25"
1LG-13	40X114	1	25"
1LG-14	40X114	1	32 3/16"
1LG-15	40X114	1	146 7/8"
1TL-1	40X114	1	162 5/8"



Wall 3			
Mark	Profile	Count	Cut Length

3BL-1	40X57	1	146 7/8"
3LG-1	40X114	10	146 7/8"
3TL-1	40X139	1	162 5/8"



Wall 2			
Mark	Profile	Count	Cut Length

2BL-1	40X57	1	146 7/8"
2LG-1	40X114	17	146 7/8"
2LG-2	40X114	1	32 5/8"
2LG-3	40X114	3	25"
2LG-4	40X114	1	32 3/16"
2LG-5	40X114	1	146 7/8"

Log profiles	
Profile	Profile



40X57	
40X114	

Log profiles	
Profile	Profile



40X114	
40X114	
40X139	



Wildlife Bunkie 40 (139"x112 3/16")

List of all items 4

Second Floor Schedule				
Mark	Type	Profile	Count	Length
FB2	FB 17x114		24	135 9/16"
FB3	FB 17x114		7	108 9/16"
TB	TB 21x95		13	139"

Second floor 2				
Mark	Type	Profile	Count	Length

CL-1	Ceiling beam 40x70		2	46 1/4"
CL-2	Ceiling beam 40x70		2	109 1/16"
CL-3	Ceiling beam 40x70		2	23 1/16"
CL-4	Ceiling beam 40x120		2	25 9/16"
CL-5	Ceiling beam 40x143		2	25"

Fence schedule				
Mark	Type	Profile	Count	Length
FN1	Fence 40x70		5	39 3/8"
FN2	Fence 18x95		3	25 9/16"



Fence schedule				
Mark	Type	Profile	Count	Length

FN3	Fence 18x95		3	32 3/16"
-----	----------------	--	---	----------



Wildlife Bunkie 40 (139"x112 3/16")

List of all items 5

Terrace Fence				
Mark	Profile	Profile	Count	Length

TN1	Fence 18x95		2	47 13/16"
TN2	Fence 18x95		43	32 3/8"
TN3	Fence 18x95		1	146 7/16"
TN4	Fence 40x143		2	142 1/4"
TN5	Fence 40x143		4	44 1/8"

Stairs				
Mark	Profile	Profile	Count	Cut Length

ST1L	Stair 40x120		1	91 1/16"
ST1R	Stair 40x120		1	91 1/16"
ST2	Stair 40x143		10	20 1/2"

Columns			
Mark	Profile	Count	Length

CM1	Post 80x70	2	77 1/16"
CM2	Post 80x70	1	79 5/16"

Ceiling Beams				
Mark	Type	Profile	Count	Length

CB	Ceiling beam 45x195		4	187"
----	------------------------	---	---	------