

# Sabrina 40 (224 7/16" x 149 5/8")

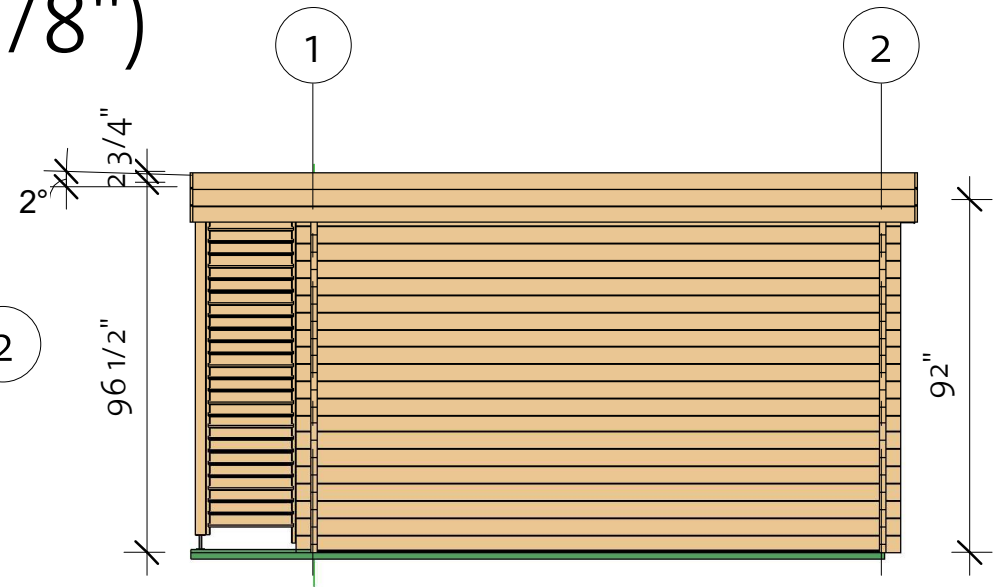

# Sabrina 40 (224 7/16" x 149 5/8")

Foundation

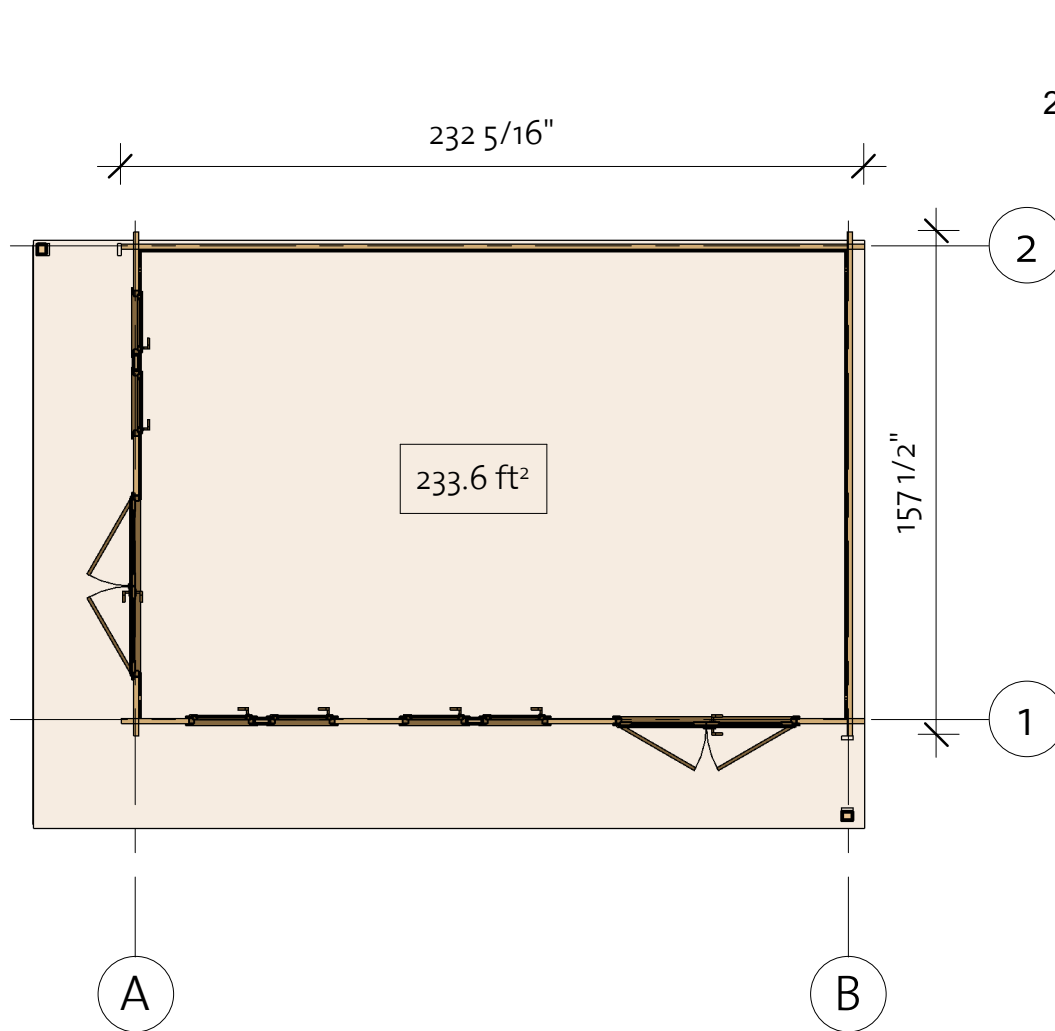
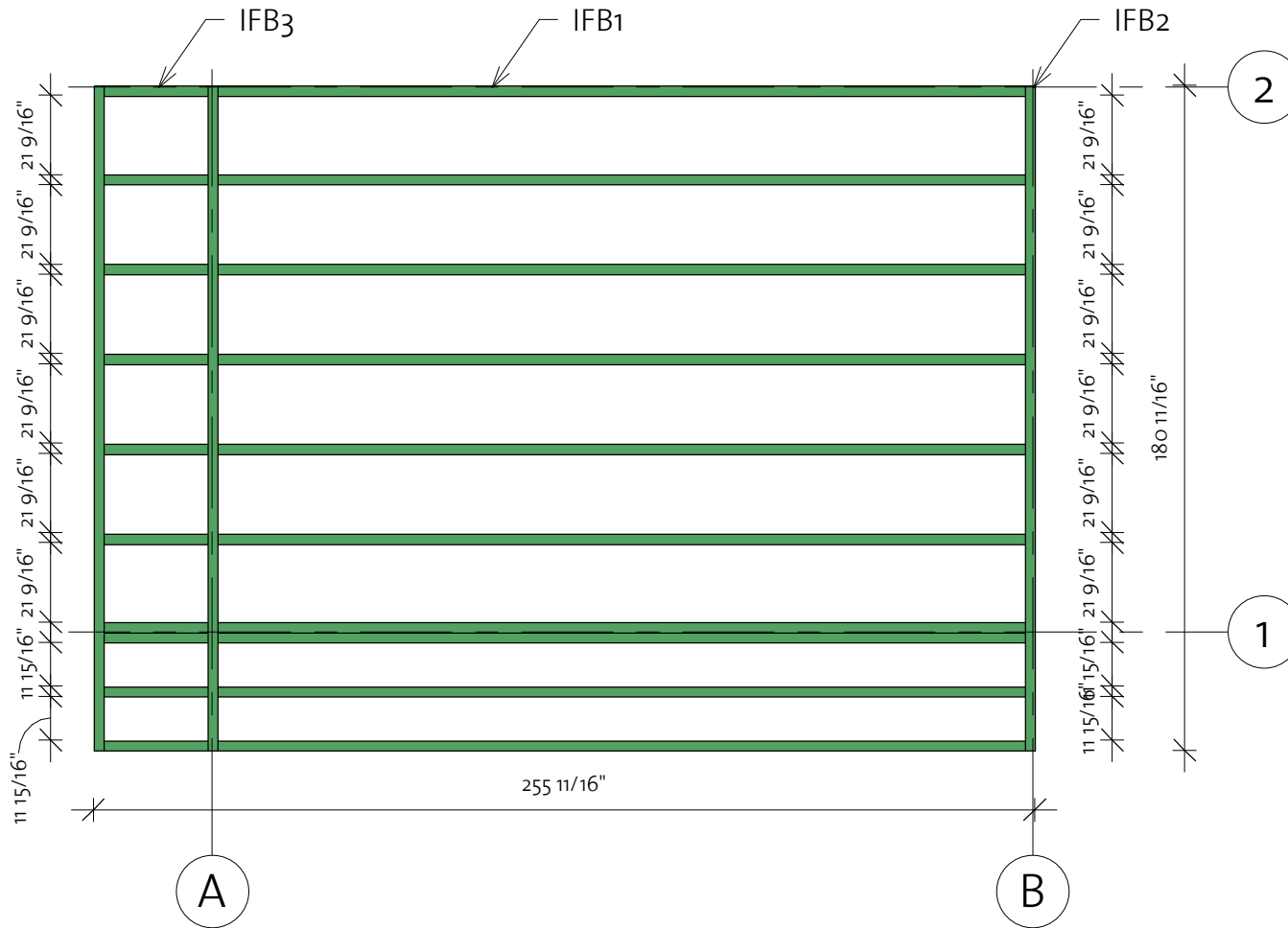

Impregnated foundation beams				
Mark	Type	Profile	Count	Length

IFB1	IFB 70x40		10	219 5/16"
IFB2	IFB 70x40		3	180 11/16"
IFB3	IFB 70x40		10	28 1/8"

# Sabrina 40 (224 7/16" x 149 5/8")

Floor Plan

① Baseboard

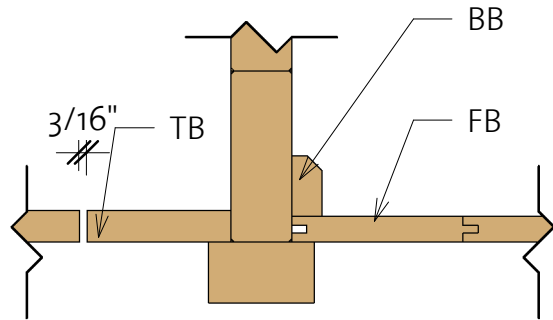

Floor Schedule

Mark	Type	Profile	Count	Length
------	------	---------	-------	--------

FB	FB 17x114		51	146 1/4"
TB1	TB 21x95		8	180 11/16"
TB2	TB 21x95		58	31 5/16"

BB1	BB 20x40		224 7/16"	2
BB2	BB 20x40		149 5/8"	2

220421

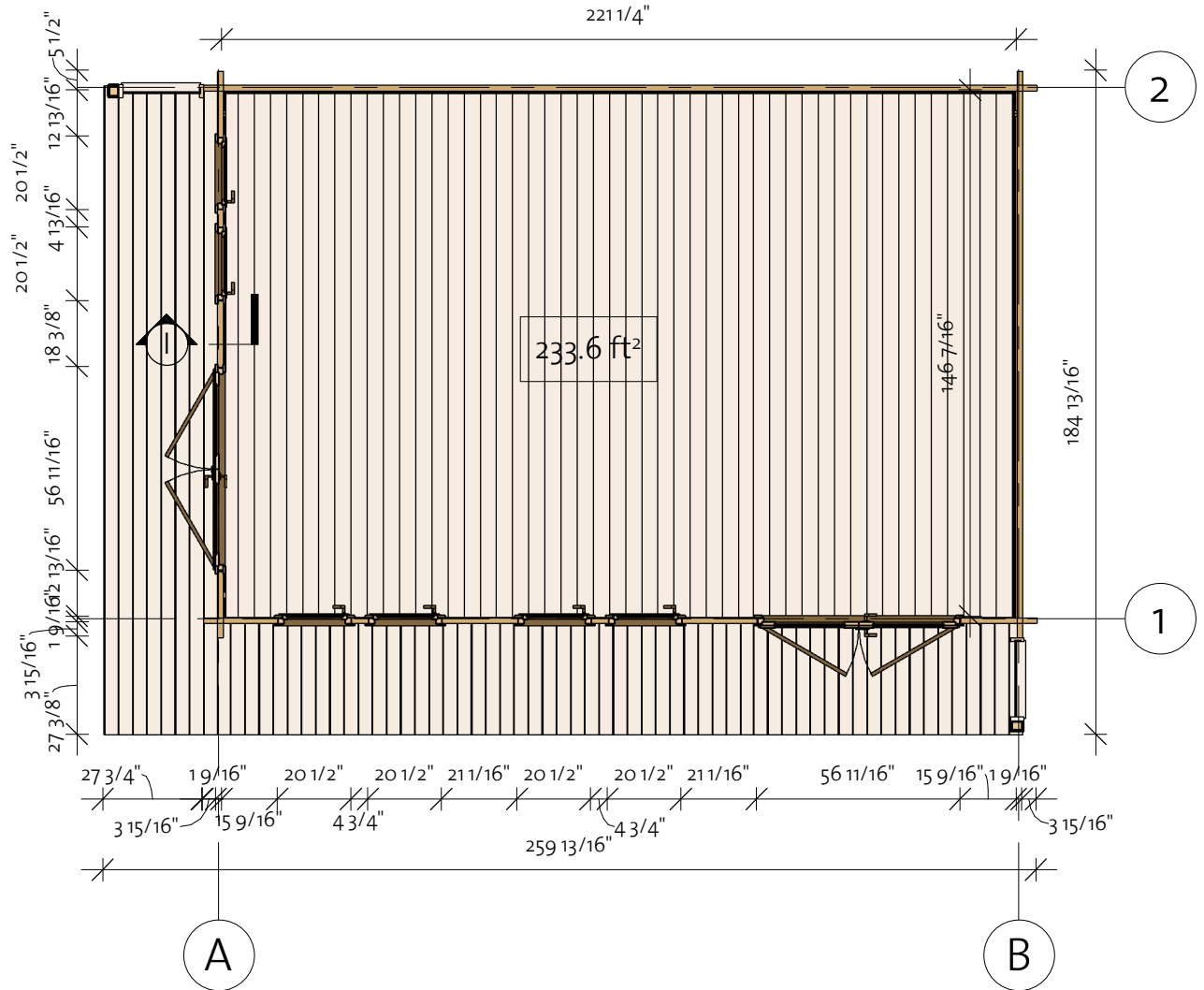

# Sabrina 40 (224 7/16" x 149 5/8")

Wall 1

Log Profile Wall 1	
Profile	Profile

40X57	
-------	---

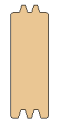
40X114	
--------	---

Log Profile Wall 1	
Profile	Profile

40X114	
--------	---

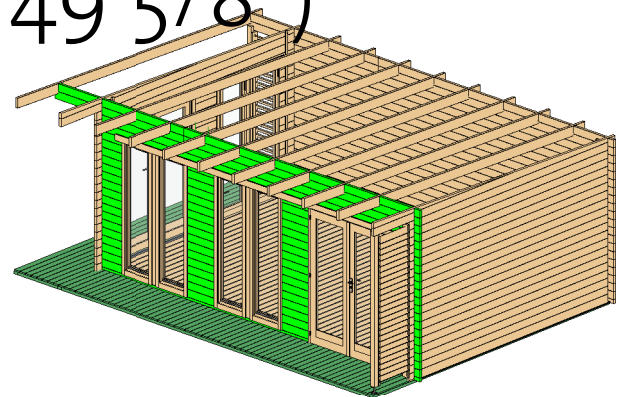

Wall 1

Mark	Profile	Count	Cut Length
------	---------	-------	------------

1BL-1	40X57	1	21 1/16"
1BL-2	40X57	1	154 1/2"
1LG-1	40X114	1	232 5/16"
1LG-2	40X114	34	21 1/16"
1LG-3	40X114	34	21 1/16"
1LG-4	40X114	1	167 5/16"
1LG-5	40X114	1	92 9/16"
1LG-6	40X114	1	232 5/16"
1TL-1	40X114	1	167 5/16"
1TL-2	40X114	1	91 7/8"

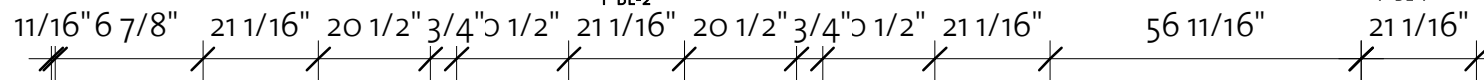
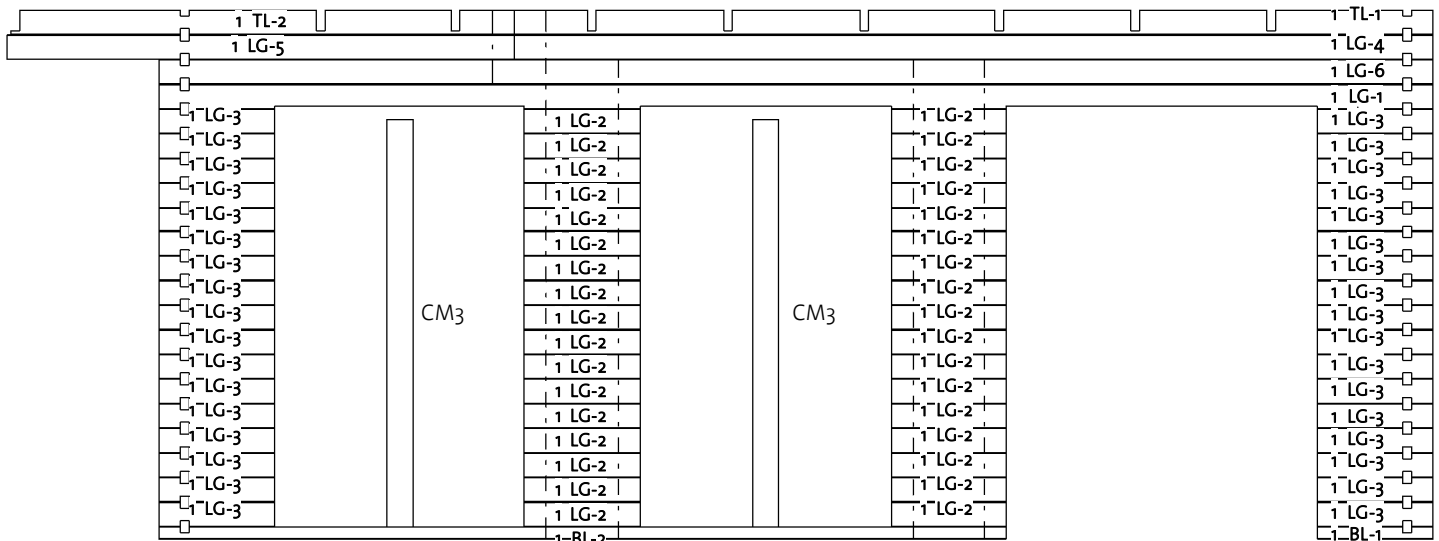

Columns Wall 1

Mark	Profile	Count	Length
------	---------	-------	--------



CM3	Post 40X120	2	74 7/16"
-----	-------------	---	----------

# Sabrina 40 (224 7/16" x 149 5/8")

Wall 2

Log Profile Wall 2	
Profile	Profile

Log Profile Wall 2	
Profile	Profile

40X57	
40X114	

40X114	
--------	---

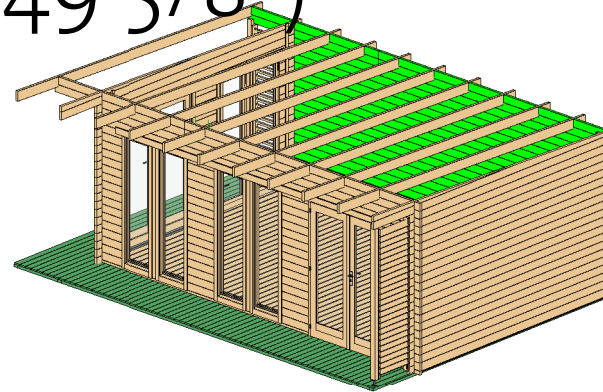

Wall 2

Mark	Profile	Count	Cut Length
------	---------	-------	------------

2BL-1	40X57	1	232 5/16"
2LG-1	40X114	1	92 9/16"
2LG-2	40X114	17	232 5/16"
2LG-3	40X114	1	167 5/16"
2LG-4	40X114	1	232 5/16"
2TL-1	40X114	1	167 5/16"
2TL-2	40X114	1	91 7/8"

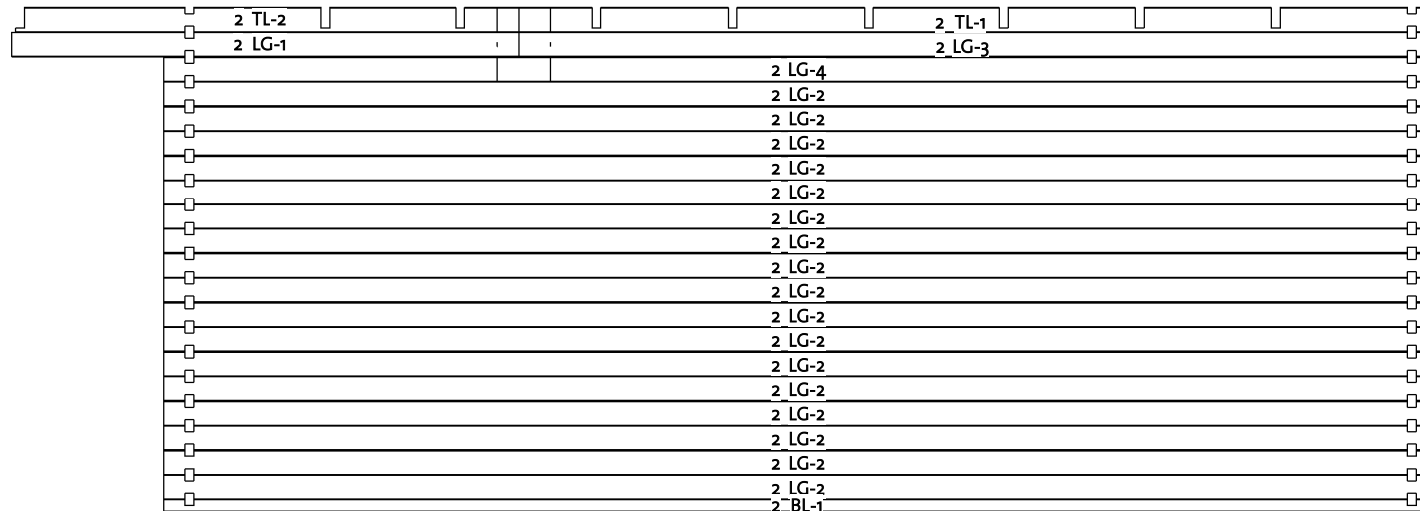

11/16" 6 7/8"

232 5/16"

220421

# Sabrina 40 (224 7/16" x 149 5/8")

Wall A

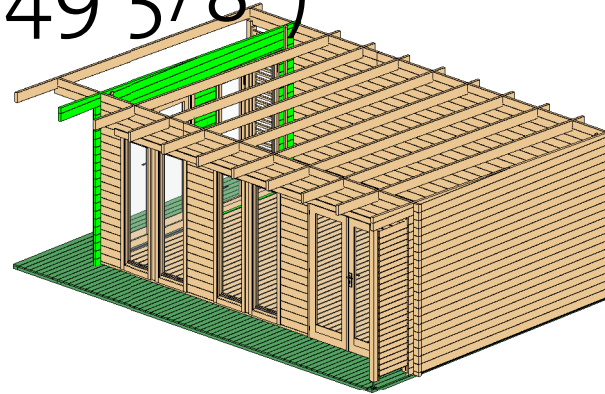

Wall A			
Mark	Profile	Count	Cut Length
ALG-1	40X114	1	157 1/2"
ALG-2	40X114	33	18 3/8"
ALG-3	40X114	16	18 7/16"
ALG-4*	40X114	1	104 3/4"
ALG-5	40X114	2	157 1/2"
ALG-6*	40X114	1	184 5/16"
ALG-7	40X114	1	82 7/16"

\* Gable - delivered premounted

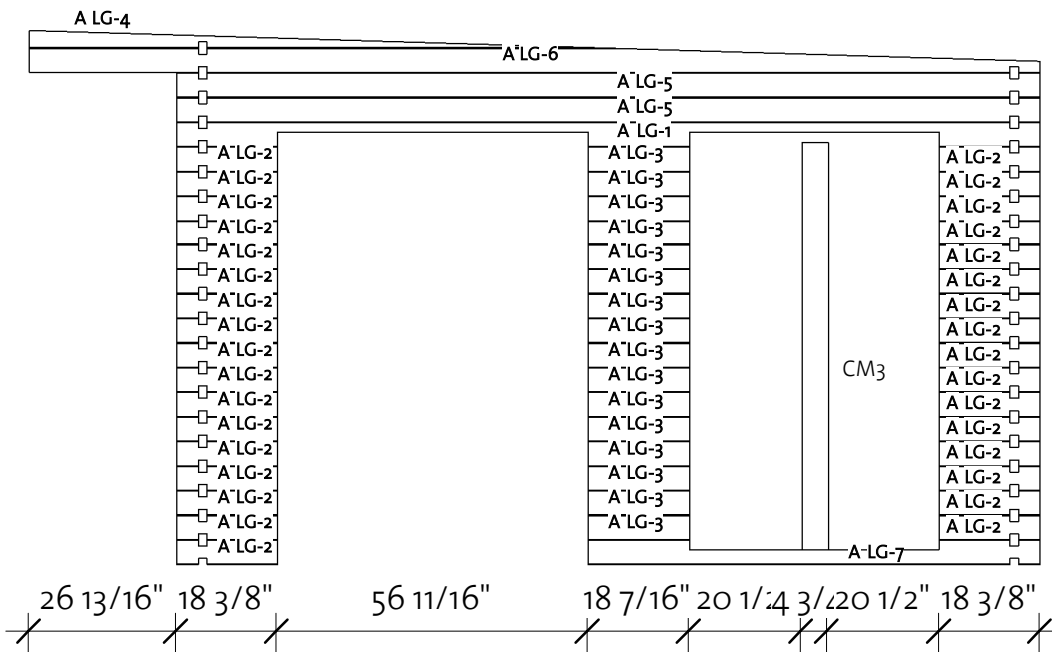

Columns Wall A			
Mark	Profile	Count	Length
CM3	Post 40x120	1	74 7/16"

Log Profile Wall A	
Profile	Profile
40X114	

# Sabrina 40 (224 7/16" x 149 5/8")

Wall B

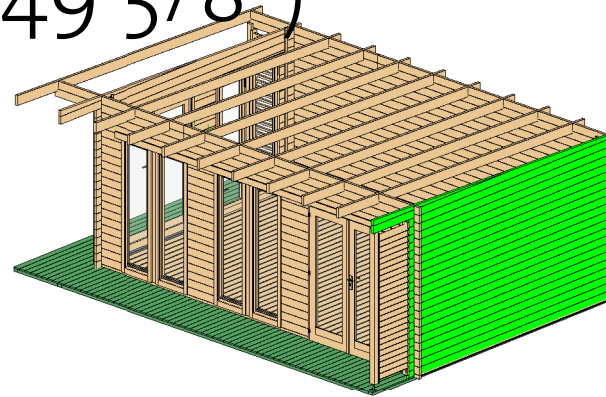

Wall B			
Mark	Profile	Count	Cut Length
BLG-1*	40X114	1	104 3/4"
BLG-2	40X114	20	157 1/2"
BLG-3*	40X114	1	184 5/16"

\* Gable - delivered premounted

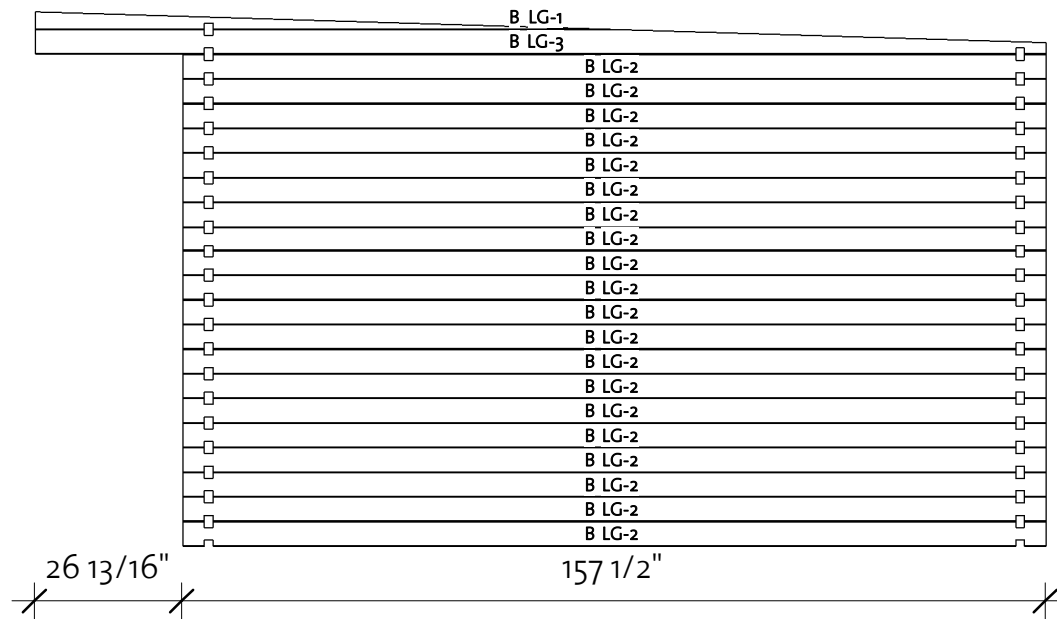

Log Profile Wall B	
Profile	Profile



40X114	
--------	--

# Sabrina 40 (224 7/16" x 149 5/8")

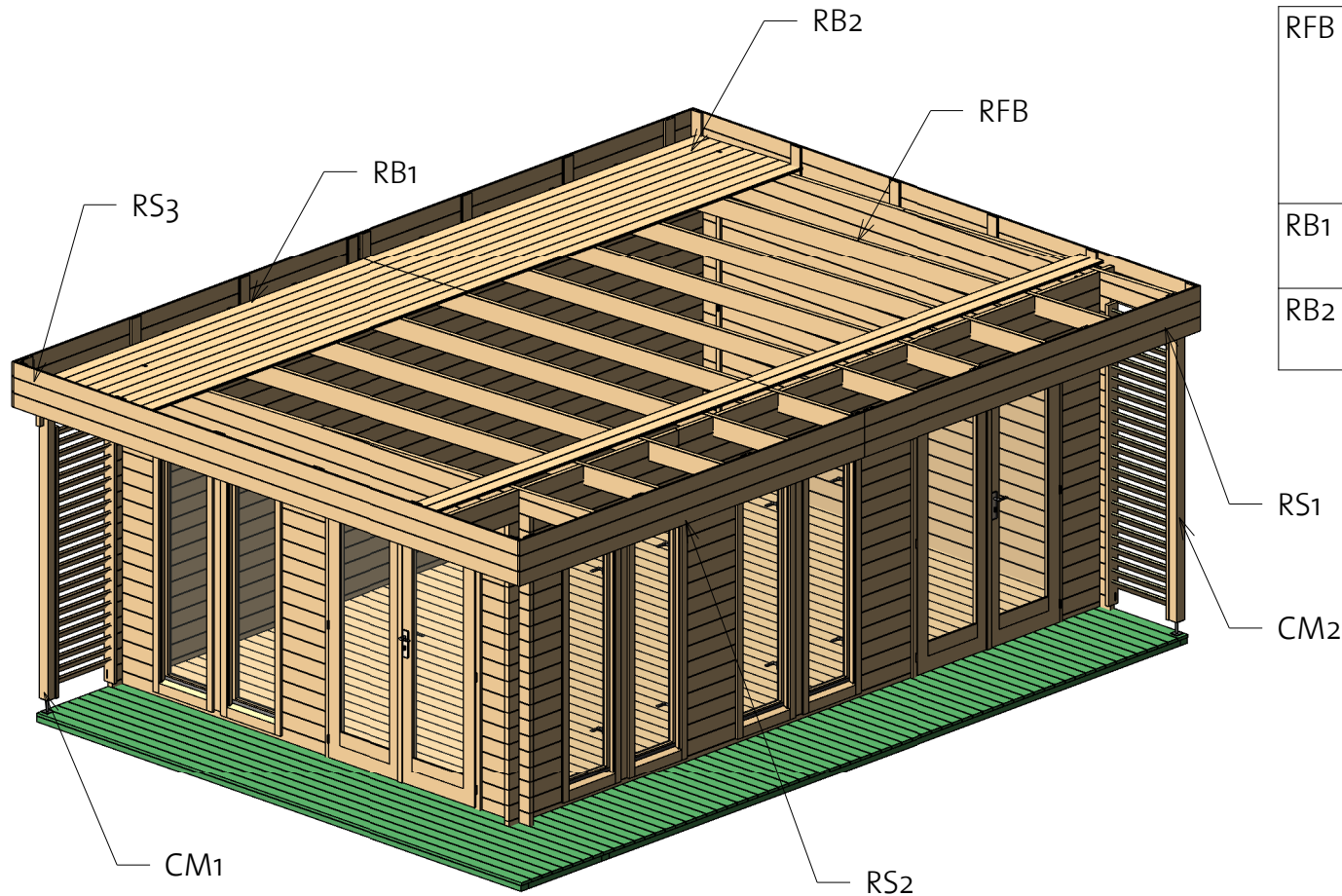
Roof 1



Roof				
Mark	Type	Profile	Count	Length

RFB	Beam 40x143		9	188 1/8"
RB1	Roofboard 17x114		42	131 5/16"
RB2	Roofboard 17x114		42	128 9/16"

## Roof Side Schedule

Type	Length	Count
------	--------	-------

RS1	129 3/16"	2
RS2	132 1/16"	2
RS3	187 7/8"	2

## Columns

Mark	Profile	Count	Length
------	---------	-------	--------



CM1	Post 80x70	1	80 1/2"
CM2	Post 80x70	1	87 1/4"



# Sabrina 40 (224 7/16" x 149 5/8")

Roof 2

Fascia Schedule				
Mark	Type	Profile	Count	Length

EE1	Eave Edging 18x95		2	130 1/16"
EE2	Eave Edging 18x95		2	184 7/16"

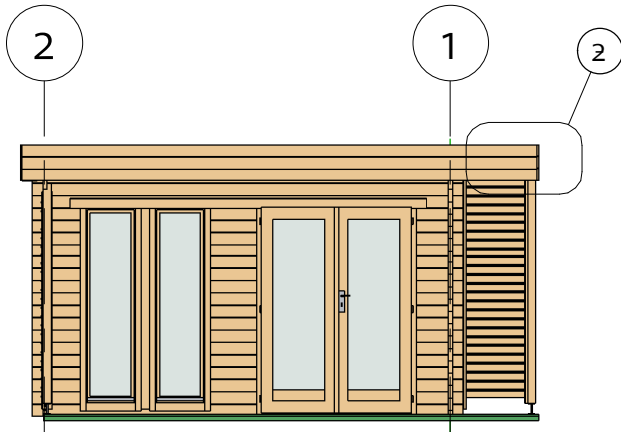

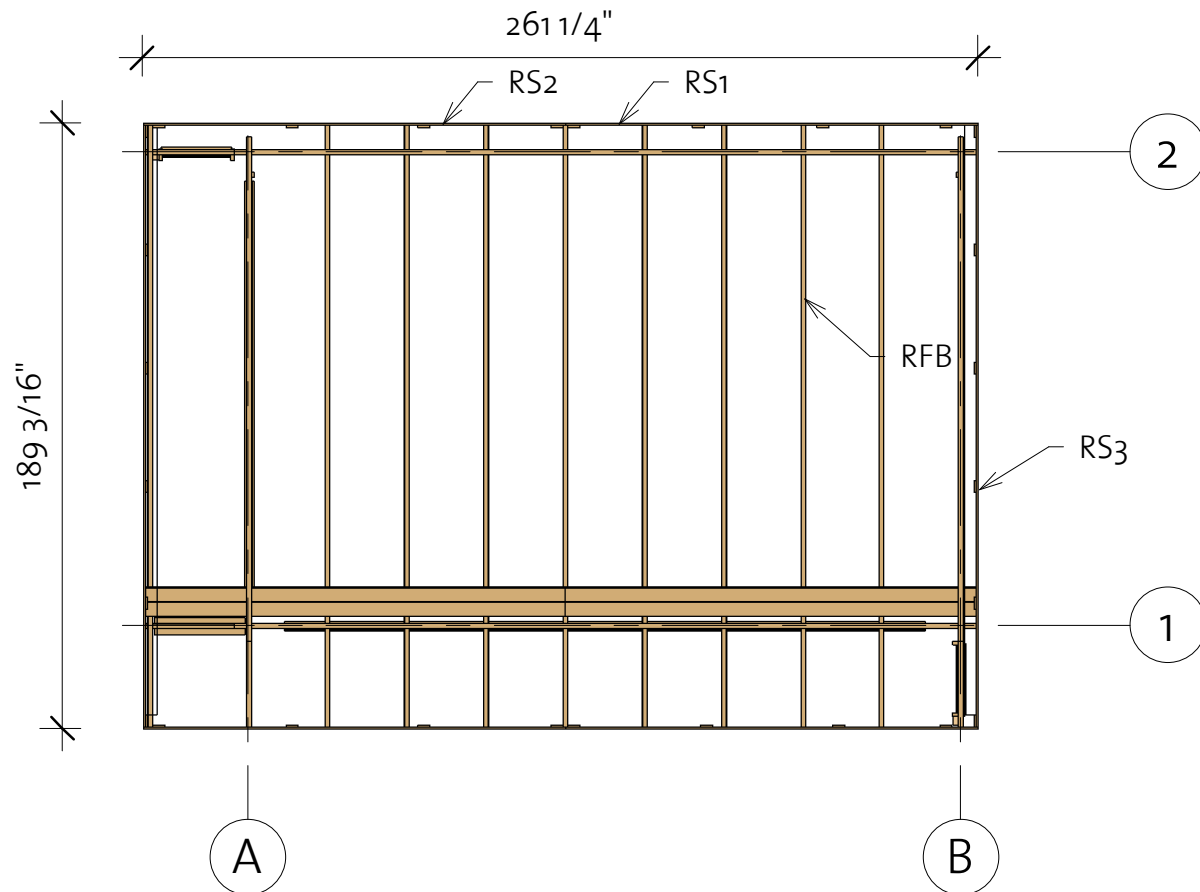
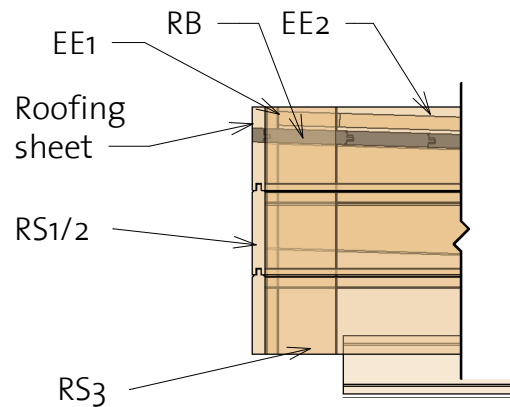

② Roof callout

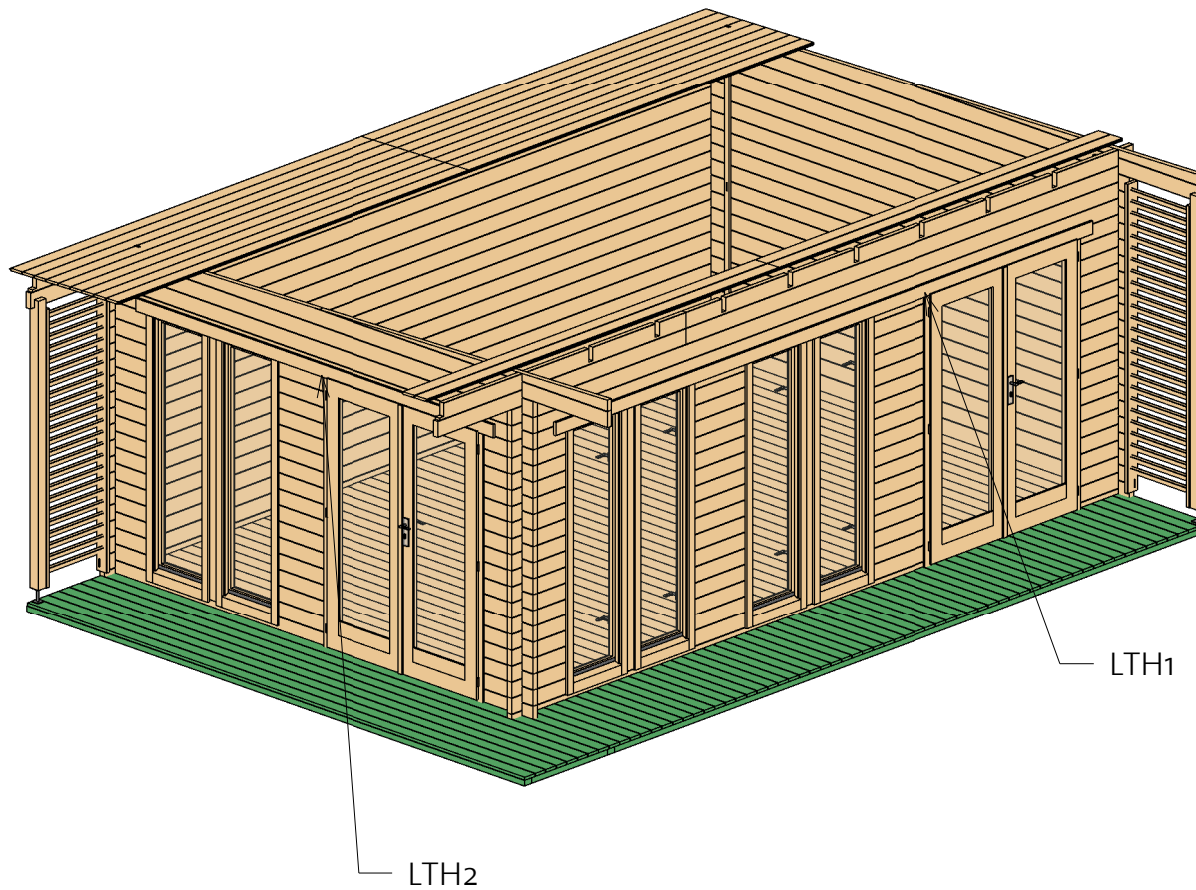

# Sabrina 40 (224 7/16" x 149 5/8")

Roof 3



Lath list				
Mark	Type	Profile	Count	Length
LTH1	18x95		2	200 13/16"
LTH2	18x95		2	129 15/16"

# Sabrina 40 (224 7/16" x 149 5/8")

Terrace

③ Terrace element 1

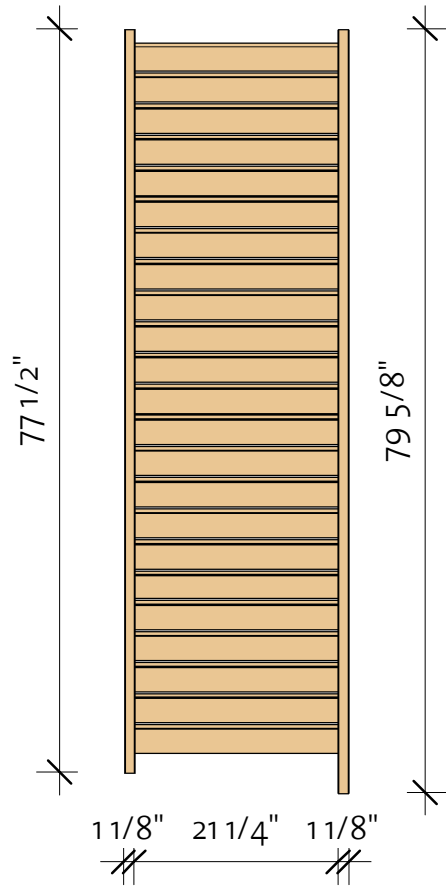

④ Terrace element 2

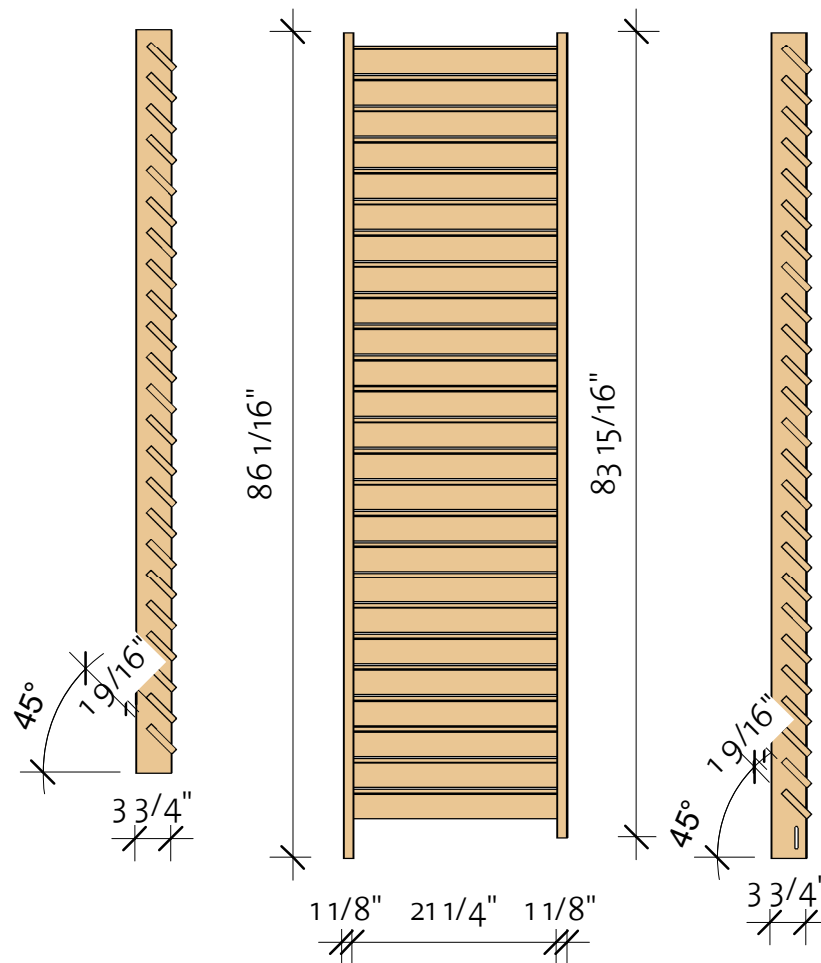

# Sabrina 40 (224 7/16" x 149 5/8")

Extras

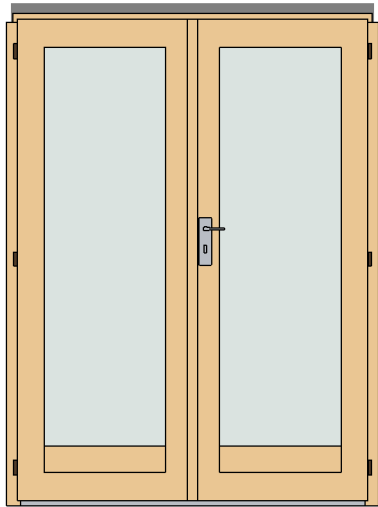

Door Schedule				
Mark	Type	Width	Height	Count
CDD3R	Classic double door 3 right	56 1/8"	76 15/16"	2
DCB8	Door Crossbar 8 optional	--	--	3/16"
DB1	Door beam 1440 mm	40	12	2

Type	Count	Length
------	-------	--------

Windboard 18x40	4	90 9/16"
-----------------	---	----------



Fasteners/Extras		
Name	Type	Count

Hitblock	300-400 mm	
Adjustable post foot		2
Screwbolt	M8x60	2
Bolts	M8 x 70	12
Screws	5,0 x 70	40
Nails	1,4 x 40	40
Dowel	16,0 x 150	75
Screws	6,0 x 140	110
Screws	4,0 x 40	1800

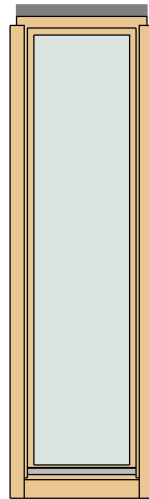

Window Schedule				
Mark	Type	Width	Height	Count

CW21R	Classic window 21 right	20 1/4"	74 7/16"	6
-------	-------------------------	---------	----------	---

WCB8	Windows Crossbar 8 optional	--	--	6
------	-----------------------------	----	----	---

\* Windows intended for tilt opening only!



# Sabrina 40 (224 7/16" x 149 5/8")

## List of all items 1



### Impregnated foundation beams

Mark	Type	Profile	Count	Length
IFB1	IFB 70x40		10	219 5/16"
IFB2	IFB 70x40		3	180 11/16"
IFB3	IFB 70x40		10	28 1/8"

### Floor Schedule



Mark	Type	Profile	Count	Length
FB	FB 17x114		51	146 1/4"
TB1	TB 21x95		8	180 11/16"
TB2	TB 21x95		58	31 5/16"

### Roof

Mark	Type	Profile	Count	Length
RFB	Beam 40x143		9	188 1/8"
RB1	Roofboard 17x114		42	131 5/16"
RB2	Roofboard 17x114		42	128 9/16"

BB1	BB 20x40		224 7/16"	2
BB2	BB 20x40		149 5/8"	2



### Fascia Schedule

Mark	Type	Profile	Count	Length
EE1	Eave Edging 18x95		2	130 1/16"
EE2	Eave Edging 18x95		2	184 7/16"

### Columns schedule

Mark	Profile	Count	Length
CM1	Post 80x70	1	80 1/2"
CM2	Post 80x70	1	87 1/4"
CM3	Post 40x120	3	74 7/16"

### Lath list

Mark	Type	Profile	Count	Length
LTH1	18x95		2	200 13/16"
LTH2	18x95		2	129 15/16"

### Terrace schedule

### Roof Side Schedule

Type	Count	Type	Length	Count
Terrace element 1	1	RS1	129 3/16"	2
Terrace element 2	1	RS2	132 1/16"	2
		RS3	187 7/8"	2

# Sabrina 40 (224 7/16" x 149 5/8")

## List of all items 2

Wall 1			
Mark	Profile	Count	Cut Length

1BL-1	40X57	1	21 1/16"
1BL-2	40X57	1	154 1/2"
1LG-1	40X114	1	232 5/16"
1LG-2	40X114	34	21 1/16"
1LG-3	40X114	34	21 1/16"
1LG-4	40X114	1	167 5/16"
1LG-5	40X114	1	92 9/16"
1LG-6	40X114	1	232 5/16"
1TL-1	40X114	1	167 5/16"
1TL-2	40X114	1	91 7/8"

Wall 2			
Mark	Profile	Count	Cut Length

2BL-1	40X57	1	232 5/16"
2LG-1	40X114	1	92 9/16"
2LG-2	40X114	17	232 5/16"
2LG-3	40X114	1	167 5/16"
2LG-4	40X114	1	232 5/16"
2TL-1	40X114	1	167 5/16"
2TL-2	40X114	1	91 7/8"

Wall A			
Mark	Profile	Count	Cut Length

ALG-1	40X114	1	157 1/2"
ALG-2	40X114	33	18 3/8"
ALG-3	40X114	16	18 7/16"
ALG-4*	40X114	1	104 3/4"
ALG-5	40X114	2	157 1/2"
ALG-6*	40X114	1	184 5/16"
ALG-7	40X114	1	82 7/16"

Wall B			
Mark	Profile	Count	Cut Length

BLG-1*	40X114	1	104 3/4"
BLG-2	40X114	20	157 1/2"
BLG-3*	40X114	1	184 5/16"

\* Gable - delivered premounted

Log Profiles	
Profile	Profile

40X57	
-------	---

Log Profiles	
Profile	Profile

40X114	
40X114	