

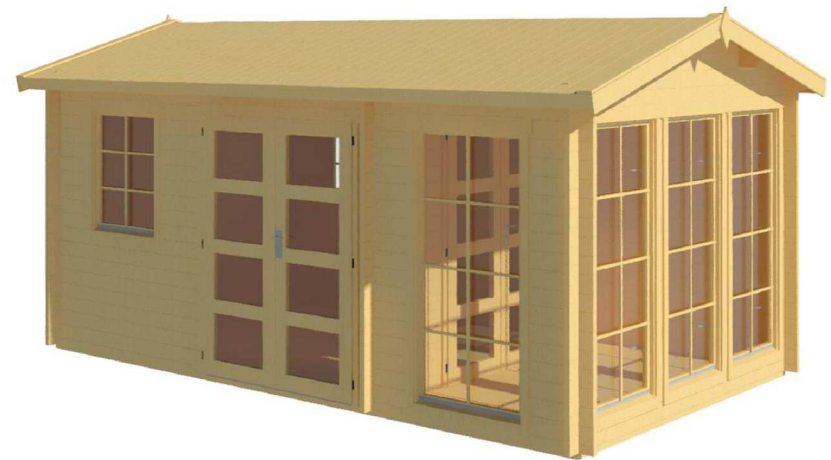

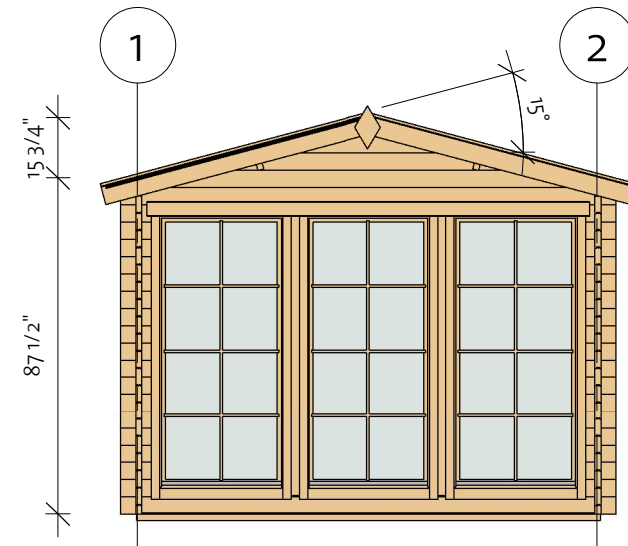

Luna 160 40 (189" x 121 1/4")

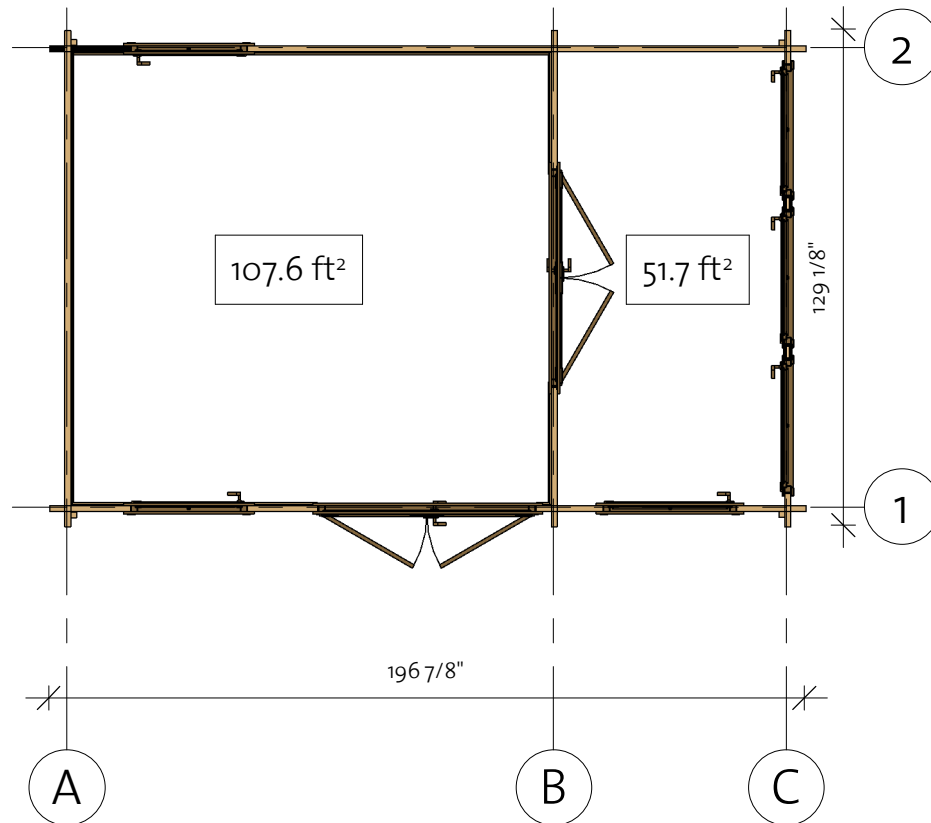
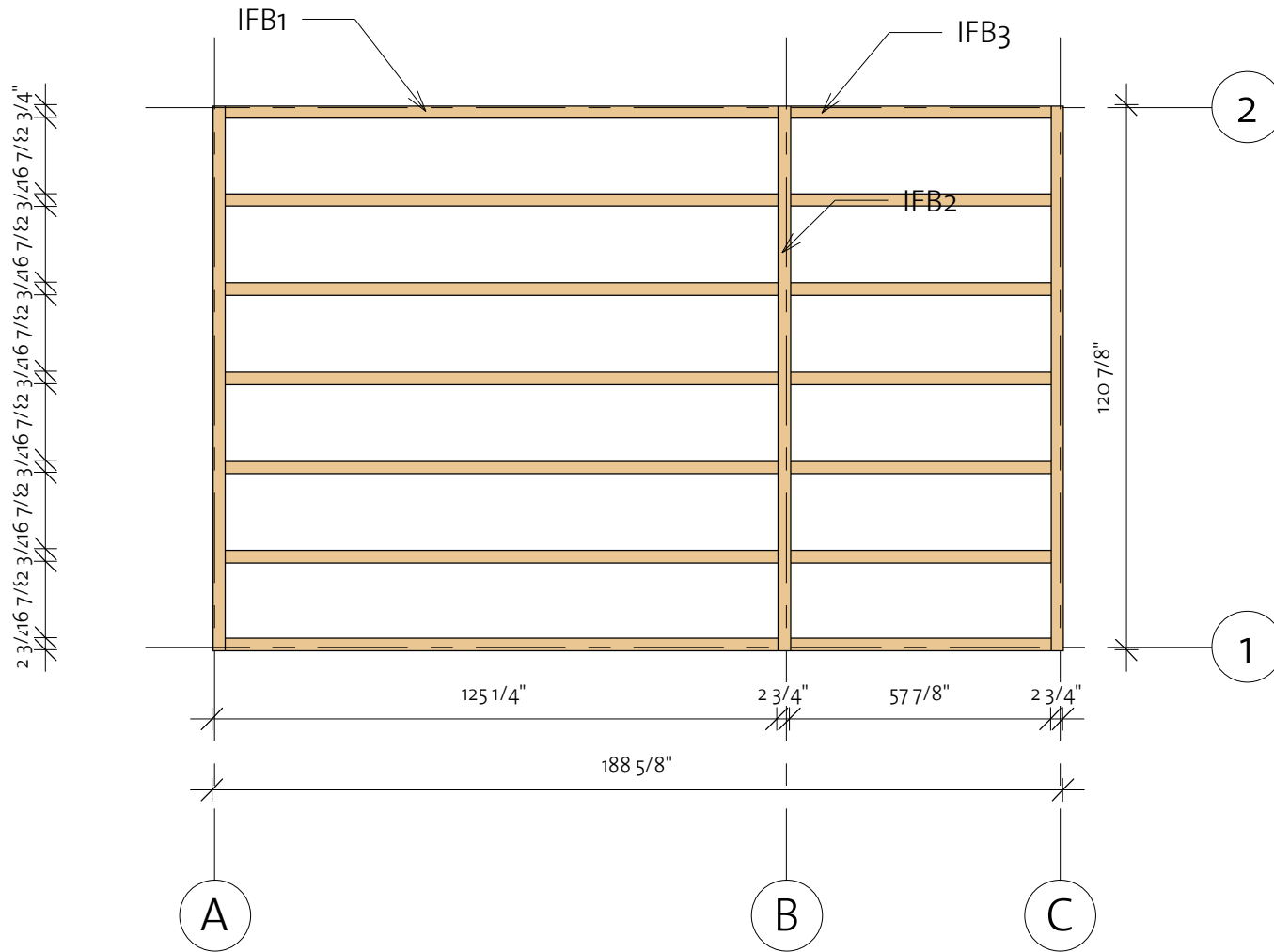

Luna 160 40 (189"x121 1/4")

Foundation



Impregnated foundation beams				
Mark	Type	Profile	Count	Length
IFB1	IFB 70x40		7	122 1/2"
IFB2	IFB 70x40		3	120 7/8"
IFB3	IFB 70x40		7	57 7/8"

Luna 160 40 (189"x121 1/4")

Floor Plan

① Baseboard

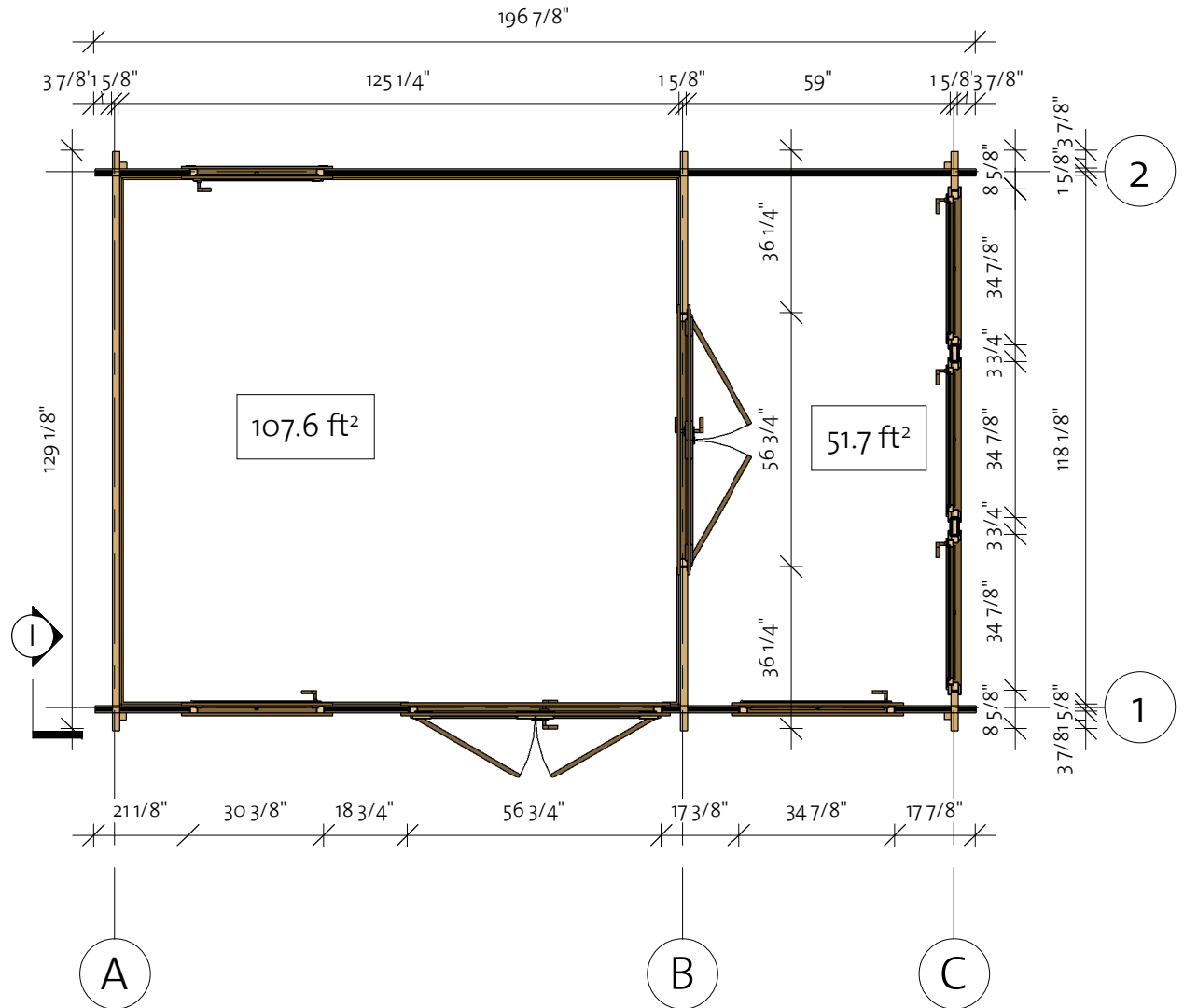
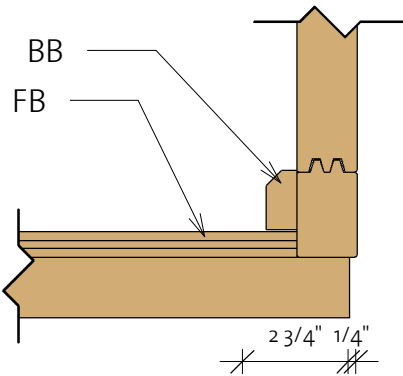

Floor Schedule

Mark	Type	Profile	Count	Length
------	------	---------	-------	--------

FB	FB 17x114		43	118"
----	-----------	--	----	------

BB1	BB 20x40		3	129 7/8"
BB2	BB 20x40		4	122"

Luna 160 40 (189"x121 1/4")

Wall 1

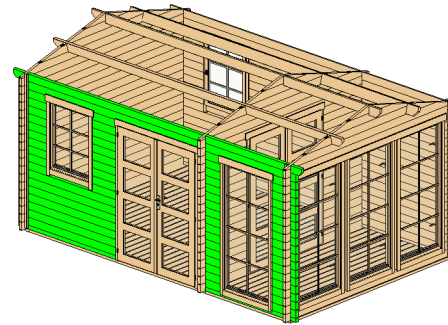

Wall 1			
Mark	Profile	Count	Cut Length

1BL-1	40X57	1	70 1/8"
1BL-2	40X57	1	70 1/8"
1LG-1	40X114	9	18 3/4"
1LG-2	40X114	9	21 1/8"
1LG-3	40X114	17	17 3/8"
1LG-4	40X114	17	17 7/8"
1LG-5	40X114	1	196 7/8"
1LG-6	40X114	8	70 1/8"
1TL-1	40X114	1	204 3/4"

Log Profile Wall 1	
Profile	Profile

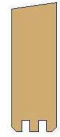
40X114	
--------	---

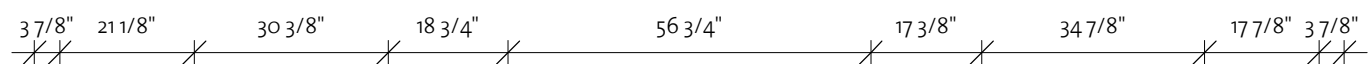
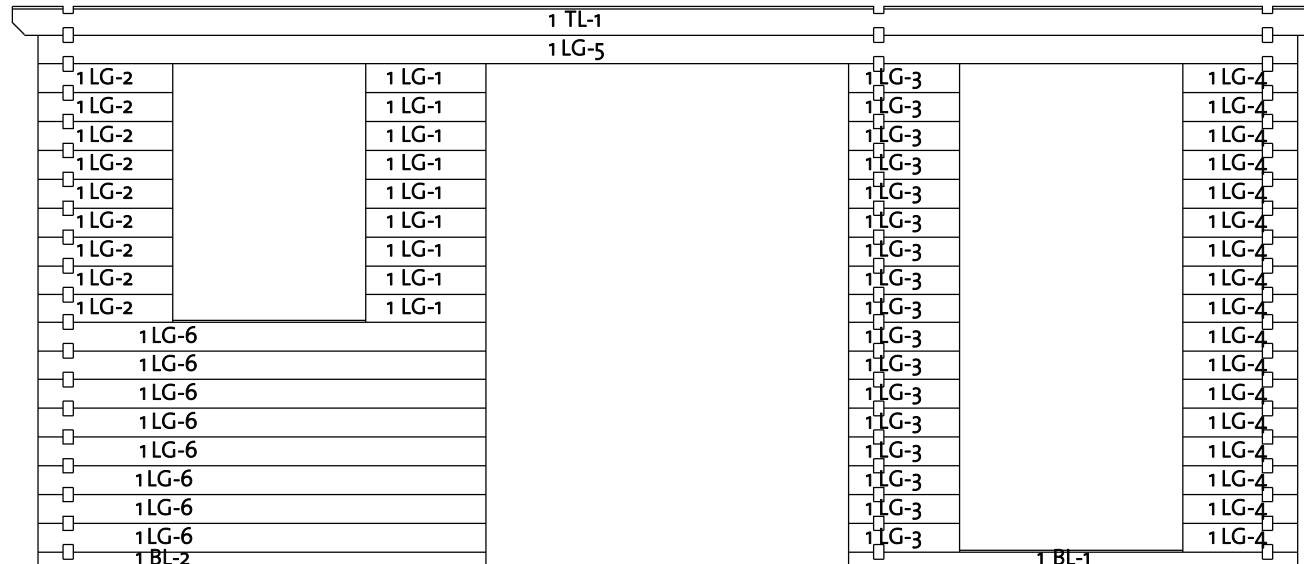

Log Profile Wall 1	
Profile	Profile

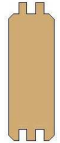
40X57	
40X114	

Luna 160 40 (189" x 121 1/4")

Wall 2

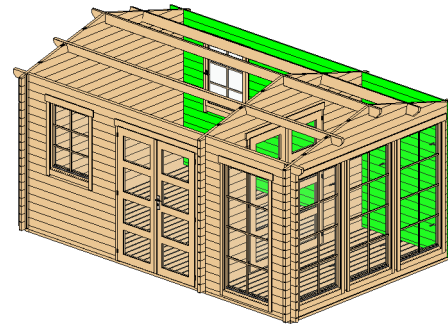

Wall 2			
Mark	Profile	Count	Cut Length

2BL-1	40X57	1	196 7/8"
2LG-1	40X114	9	196 7/8"
2LG-2	40X114	9	145 1/2"
2LG-3	40X114	9	211 1/8"
2TL-1	40X114	1	204 3/4"

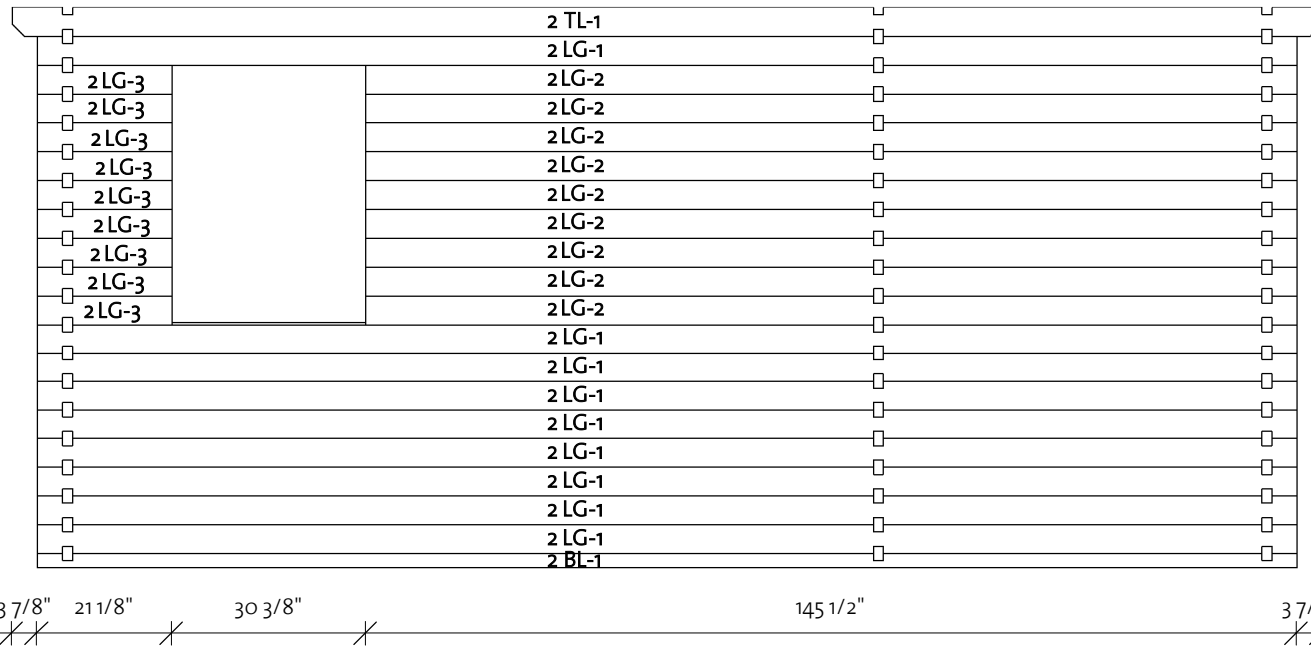

Log Profile Wall 2	
Profile	Profile

40X57	
40X114	
40X114	

Luna 160 40 (189"x121 1/4")

Wall A

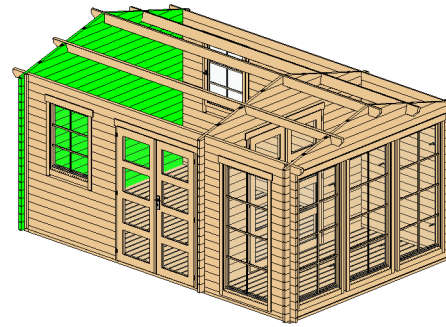

Wall A			
Mark	Profile	Count	Cut Length

ALG-1*	40x114	1	33 3/4"
ALG-2*	40x114	1	67 1/2"
ALG-3*	40x114	1	101 1/4"
ALG-4	40x114	19	129 1/8"
ALG-5*	40x114	1	129 1/8"

*Gable-delivered premounted

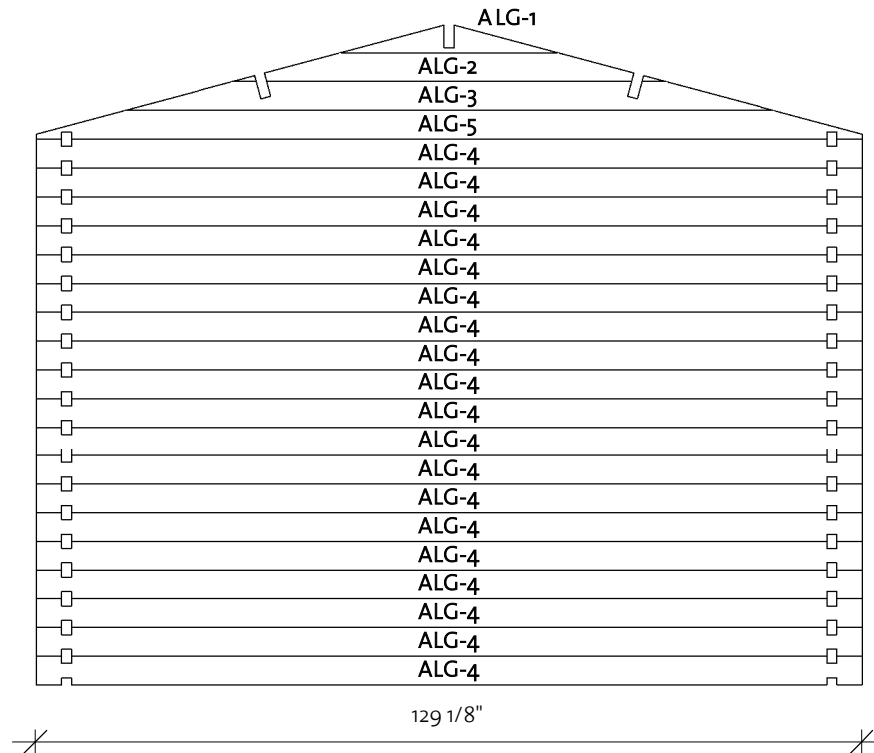

Log Profile Wall A	
Profile	Profile

40x114	
--------	--

Luna 160 40 (189"x121 1/4")

Wall B

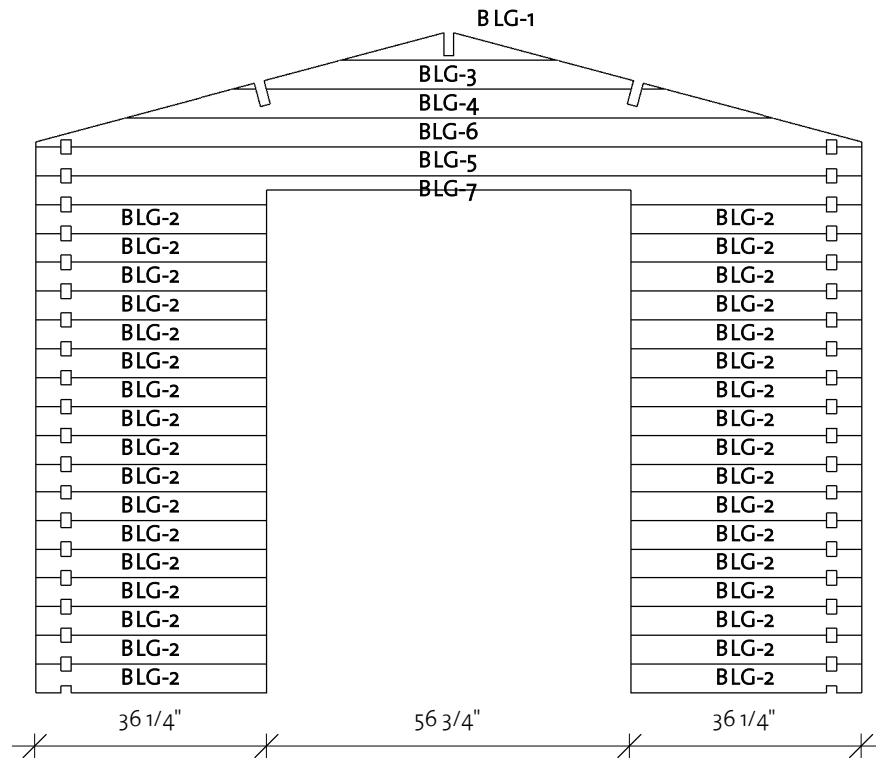
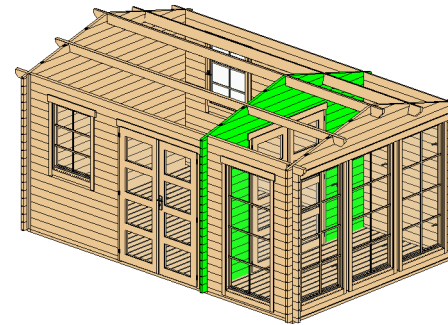

Wall B			
Mark	Profile	Count	Cut Length

BLG-1*	40X114	1	33 3/4"
BLG-2	40X114	34	36 1/4"
BLG-3*	40X114	1	67 1/2"
BLG-4*	40X114	1	101 1/4"
BLG-5	40X114	1	129 1/8"
BLG-6*	40X114	1	129 1/8"
BLG-7	40X114	1	129 1/8"

*Gable-delivered premounted

Log Profile Wall B	
Profile	Profile

40X114	
--------	--

Luna 160 40 (189"x121 1/4")

Wall C

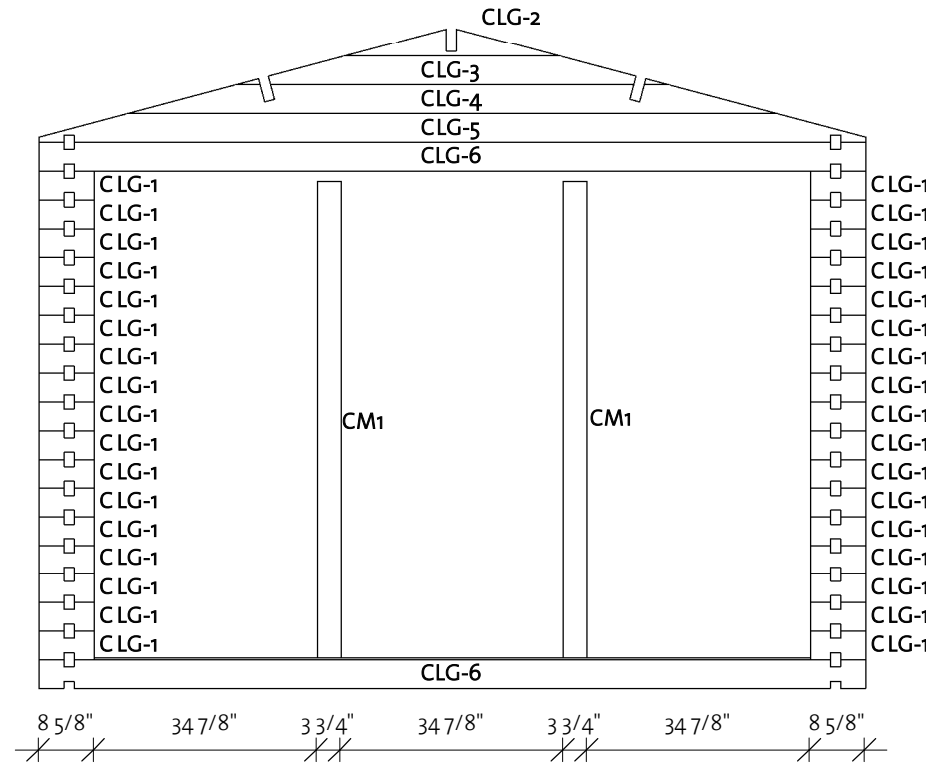
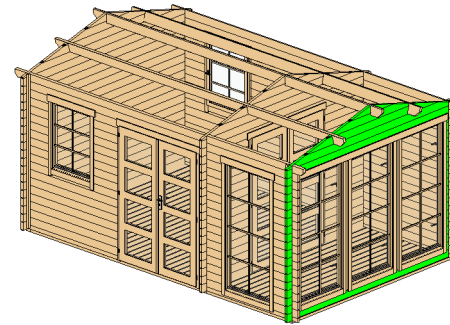

Wall C			
Mark	Profile	Count	Cut Length

CLG-1	40x114	34	8 5/8"
CLG-2*	40x114	1	33 3/4"
CLG-3*	40x114	1	67 1/2"
CLG-4*	40x114	1	101 1/4"
CLG-5*	40x114	1	129 1/8"
CLG-6	40x114	2	129 1/8"

*Gable-delivered premounted

Log Profile Wall C	
Profile	Profile

Columns			
Mark	Profile	Count	Length

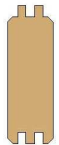

CM1	Post 40x94	2	74 3/8"
-----	------------	---	---------

40x114	
--------	---

Luna 160 40 (189"x121 1/4")

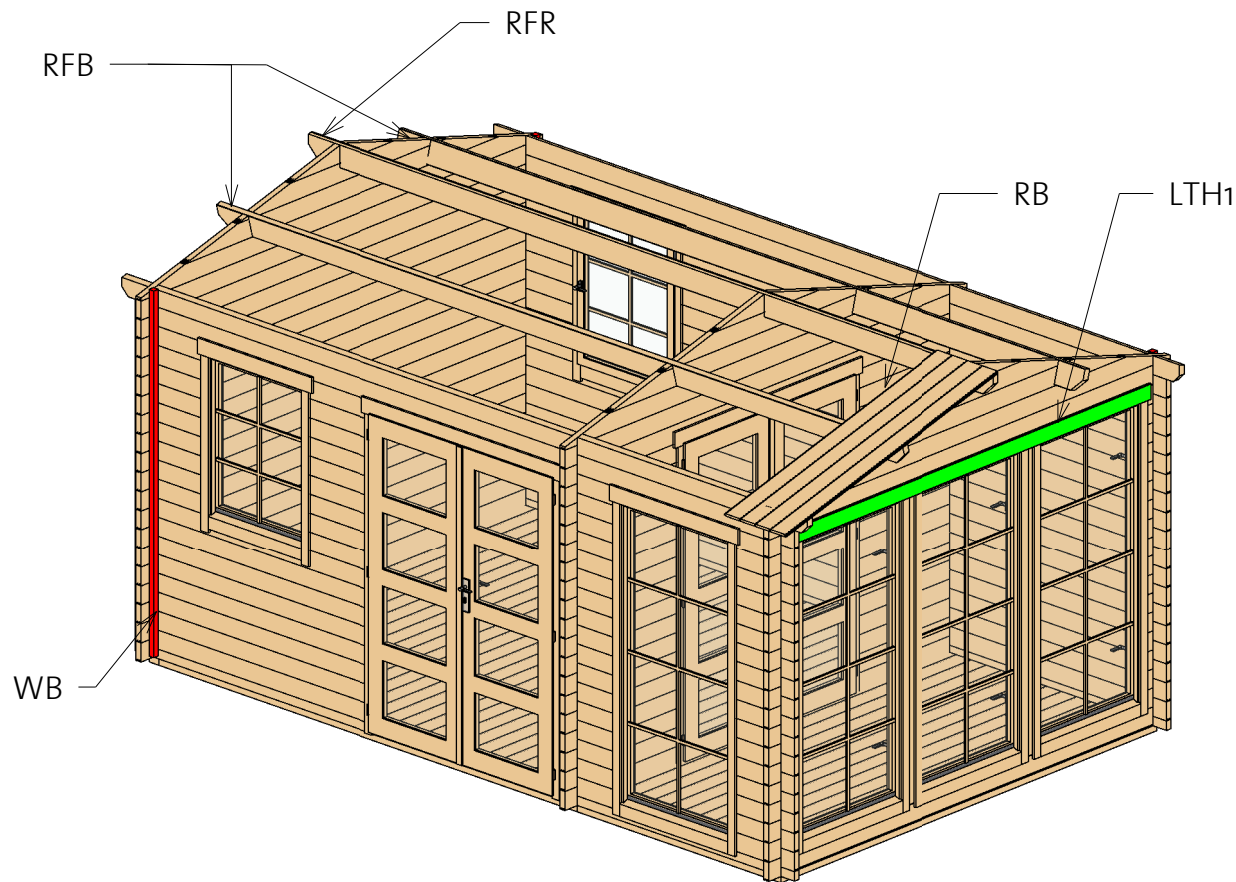
Roof 1



Roof				
Mark	Type	Profile	Count	Length
RFR	Ridge 40x143		1	204 3/4"
RFB	Beam 40x143		2	204 3/4"
RB	17x114		94	70 3/4"

Lath list				
Mark	Type	Profile	Count	Length
LTH1	18x95		2	115 3/8"

Luna 160 40 (189"x121 1/4")

Roof 2

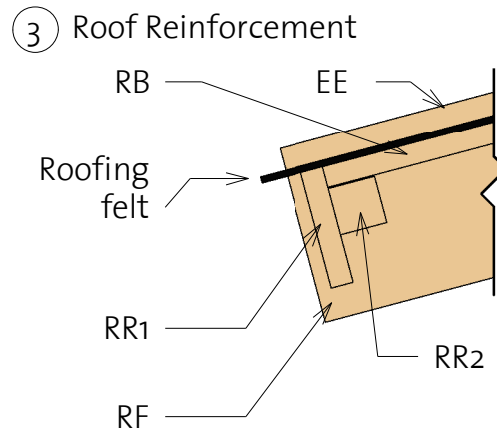
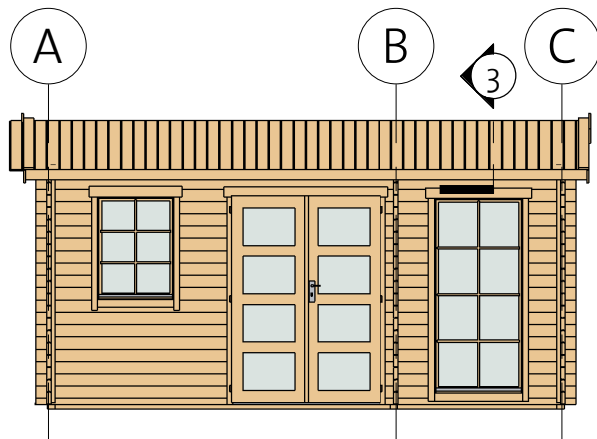
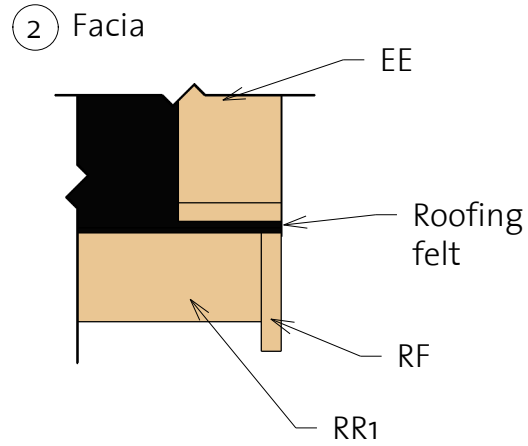
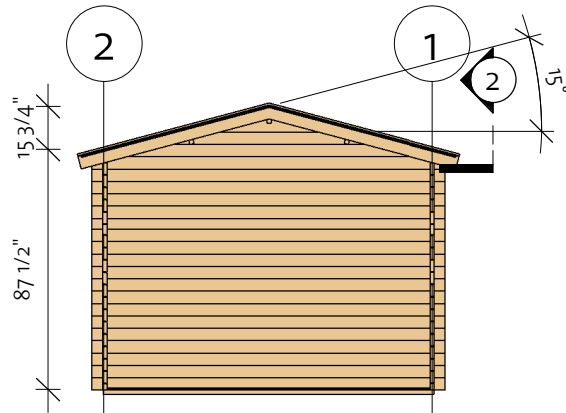

Fascia Schedule				
Mark	Type	Profile	Count	Length
EE	Eave Edging 18x95		4	72"
RF	Roof Fascia 18x120		4	72"
RR1	Roof reinforcement 18x95		2	204 3/4"
RR2	Roof reinforcement 38x38		2	204 3/4"

Luna 160 40 (189"x121 1/4")

Extras

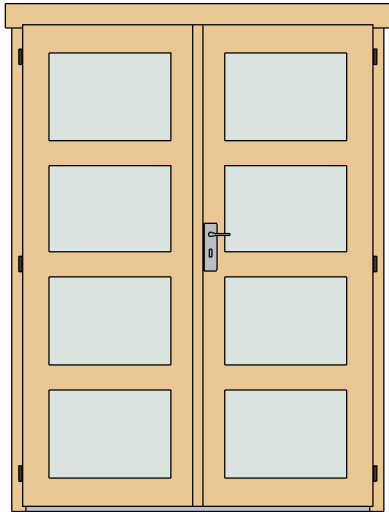

Door Schedule				
Mark	Type	Width	Height	Count
CDD2R	Classic double door 2, four glass right	56 1/8"	77"	2

Fasteners & Extras		
Name	Type	Count

Hitblock	300-400 mm	
Screws	5,0 x 70	20
Bolts	M8 x 90	20
Nails	1,4 x 40	45
Screws	6,0 x 140	75
Screws	4,0 x 40	750

Family	Count
Romb	2

◆

Windboard		
Type	Count	Length
Windboard 38x38	4	86 5/8"

- * Windows intended for tilt opening only!
- * Fenster zur Eröffnung nur zum Kippen vorgesehen!
- * Aknad on ette nähtud ainult kaldu avamiseks!

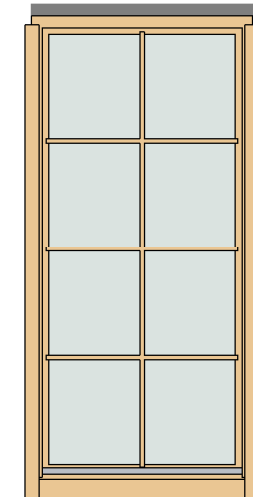
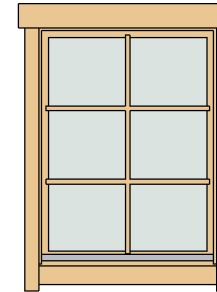





Window Schedule				
Mark	Type	Width	Height	Count
CW1R	Classic window 1 right	30 1/8"	39"	2
CW4R	Classic window 4 right	34 1/2"	74 3/8"	1
CW4R	Classic window 4 right	34 1/2"	74 3/8"	3



WCB10	Windows Crossbar 10	--	--	2
WCB8.2	Windows Crossbar 8.2	--	--	4





Luna 160 40 (189"x121 1/4")

List of all items 1

Impregnated foundation beams				
Mark	Type	Profile	Count	Length
IFB1	IFB 70x40		7	122 1/2"
IFB2	IFB 70x40		3	120 7/8"
IFB3	IFB 70x40		7	57 7/8"

Floor Schedule				
Mark	Type	Profile	Count	Length
FB	FB 17x114		43	118"
BB1	BB 20x40		3	129 7/8"
BB2	BB 20x40		4	122"

Roof				
Mark	Type	Profile	Count	Length
RFR	Ridge 40x143		1	204 3/4"
RFB	Beam 40x143		2	204 3/4"
RB	17x114		94	70 3/4"

Fascia Schedule				
Mark	Type	Profile	Count	Length
EE	Eave Edging 18x95		4	72"
RF	Roof Fascia 18x120		4	72"
RR1	Roof reinforcement 18x95		2	204 3/4"
RR2	Roof reinforcement 38x38		2	204 3/4"

Luna 160 40 (189"x121 1/4")

List of all items 2

Wall 1			
Mark	Profile	Count	Cut Length

1BL-1	40X57	1	70 1/8"
1BL-2	40X57	1	70 1/8"
1LG-1	40X114	9	18 3/4"
1LG-2	40X114	9	21 1/8"
1LG-3	40X114	17	17 3/8"
1LG-4	40X114	17	17 7/8"
1LG-5	40X114	1	196 7/8"
1LG-6	40X114	8	70 1/8"
1TL-1	40X114	1	204 3/4"

Wall 2			
Mark	Profile	Count	Cut Length

2BL-1	40X57	1	196 7/8"
2LG-1	40X114	9	196 7/8"
2LG-2	40X114	9	145 1/2"
2LG-3	40X114	9	21 1/8"
2TL-1	40X114	1	204 3/4"



Lath list				
Mark	Type	Profile	Count	Length

LTH1	18x95		2	115 3/8"
------	-------	---	---	----------

Columns			
Mark	Profile	Count	Length

CM1	Post 40x94	2	74 3/8"
-----	------------	---	---------

Log Profiles1	
Profile	Profile

40X57	
40X114	

Log Profiles1	
Profile	Profile

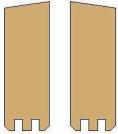
40X114	
--------	---

Luna 160 40 (189"x121 1/4")

List of all items 3

Wall A			
Mark	Profile	Count	Cut Length

ALG-1*	40X114	1	33 3/4"
ALG-2*	40X114	1	67 1/2"
ALG-3*	40X114	1	101 1/4"
ALG-4	40X114	19	129 1/8"
ALG-5*	40X114	1	129 1/8"

Wall C			
Mark	Profile	Count	Cut Length

CLG-1	40X114	34	8 5/8"
CLG-2*	40X114	1	33 3/4"
CLG-3*	40X114	1	67 1/2"
CLG-4*	40X114	1	101 1/4"
CLG-5*	40X114	1	129 1/8"
CLG-6	40X114	2	129 1/8"

Log Profiles2	
Profile	Profile

40X114	
--------	---

Wall B			
Mark	Profile	Count	Cut Length

BLG-1*	40X114	1	33 3/4"
BLG-2	40X114	34	36 1/4"
BLG-3*	40X114	1	67 1/2"
BLG-4*	40X114	1	101 1/4"
BLG-5	40X114	1	129 1/8"
BLG-6*	40X114	1	129 1/8"
BLG-7	40X114	1	129 1/8"

*Gable-delivered premounted