

Lancaster 40 (155 1/2" x 155 1/2")

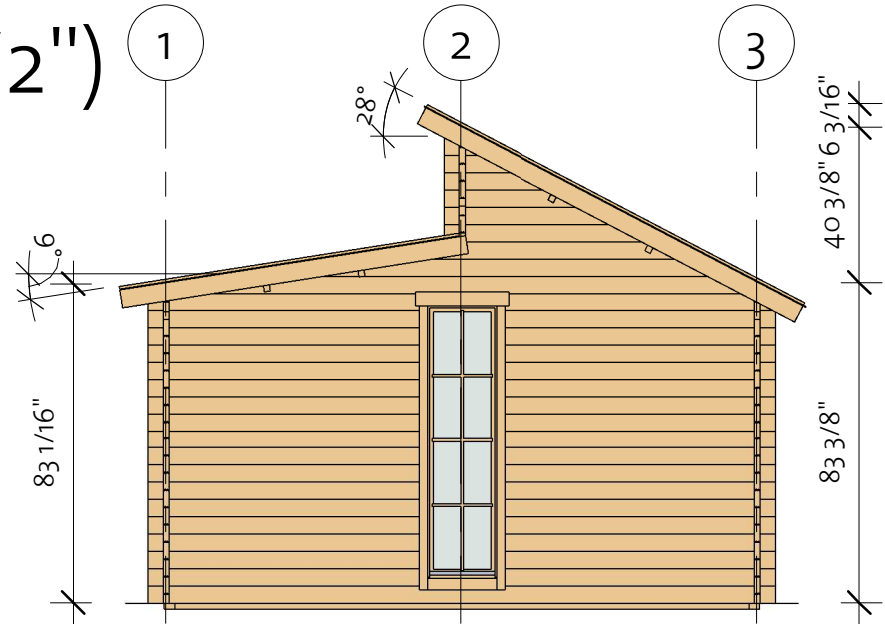
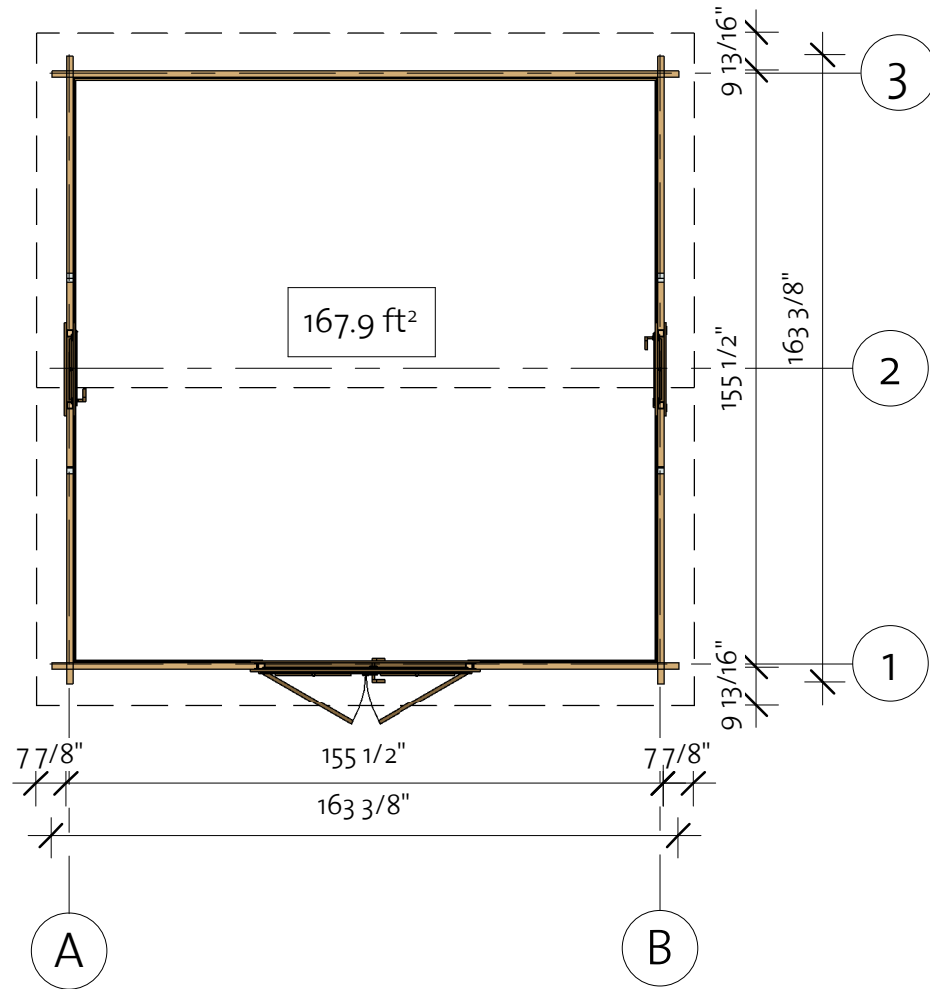

EZ Log Structures
Do-It-Yourself Building Kits

Lancaster 40 (155 1/2" x 155 1/2")

Foundation

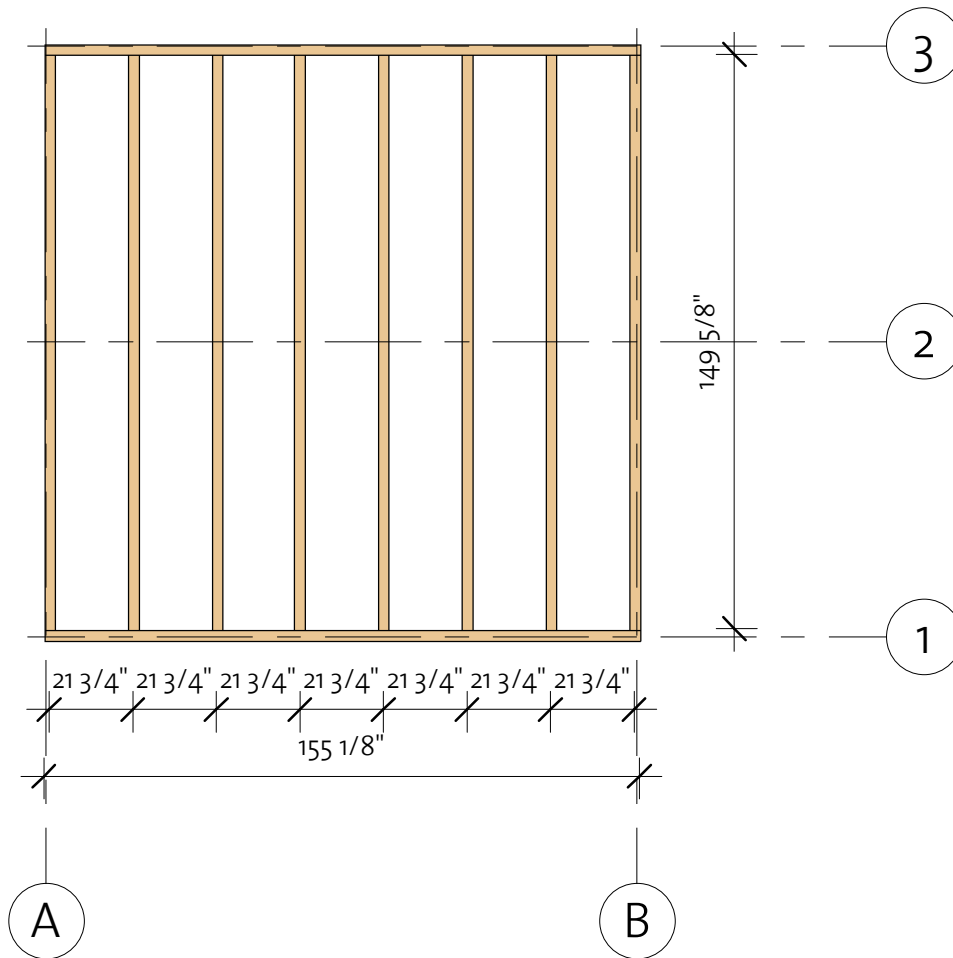



Impregnated foundation beams				
Mark	Type	Profile	Count	Length
IFB1	IFB 70x40		2	155 1/8"
IFB2	IFB 70x40		8	149 5/8"

Lancaster 40 (155 1/2" x 155 1/2")

Floor Plan

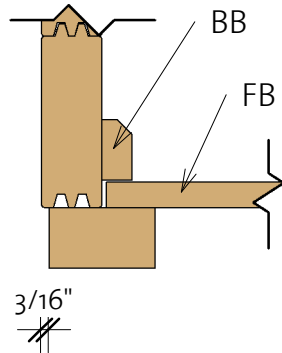
① Baseboard



Floor Schedule				
Mark	Type	Profile	Count	Length
FB	FB 17X114		34	152 1/8"
BB	BB 20X40		4	155 1/2"

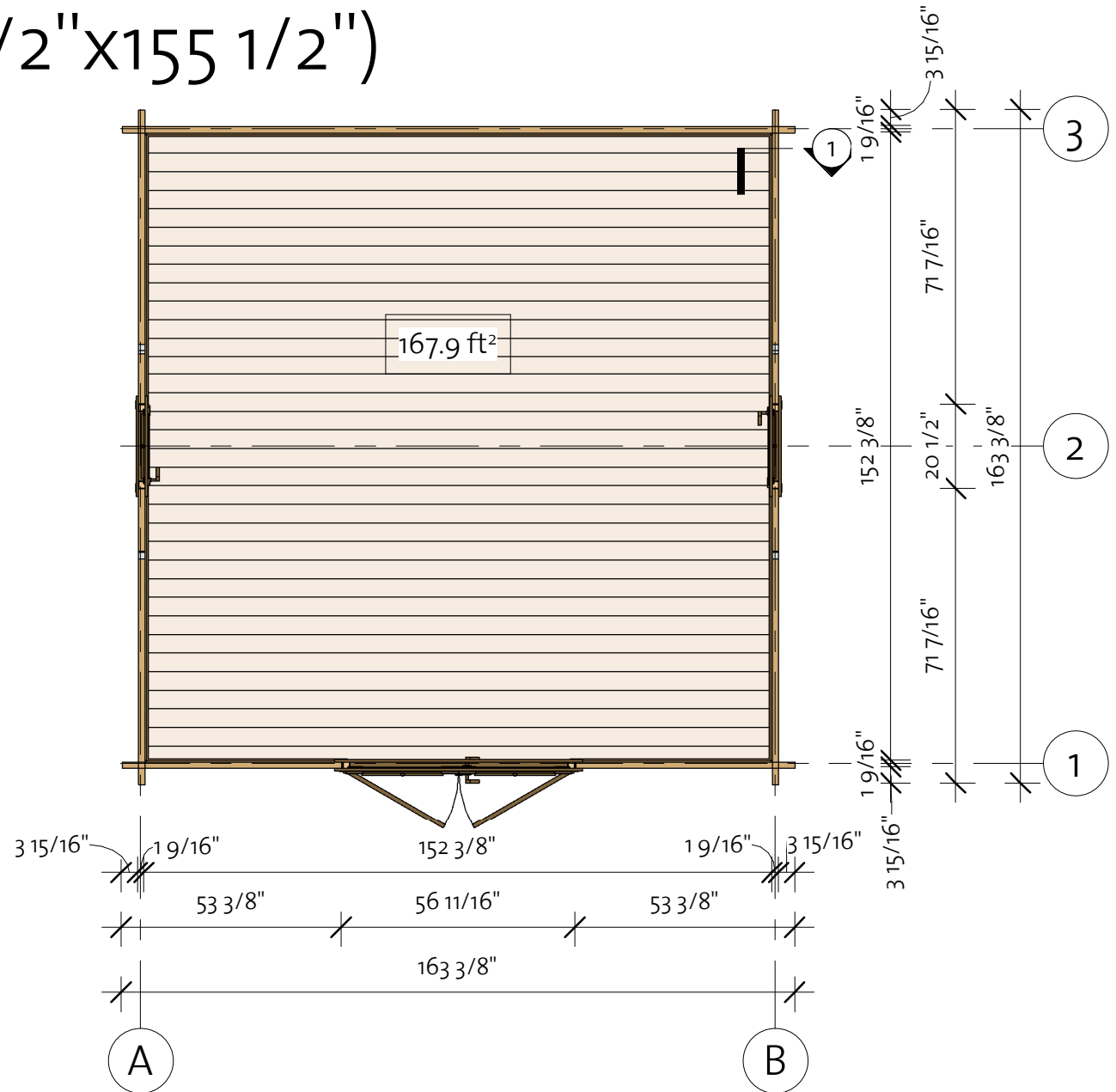

Lancaster 40 (155 1/2" x 155 1/2")

Wall 1

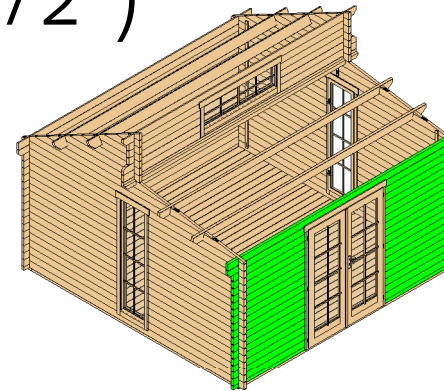

Wall 1			
Mark	Profile	Count	Cut Length

1BL-1	4OX57	2	53 3/8"
1LG-1	4OX114	32	53 3/8"
1LG-2	4OX114	2	57 5/16"
1TL-1	4OX114	1	171 1/4"

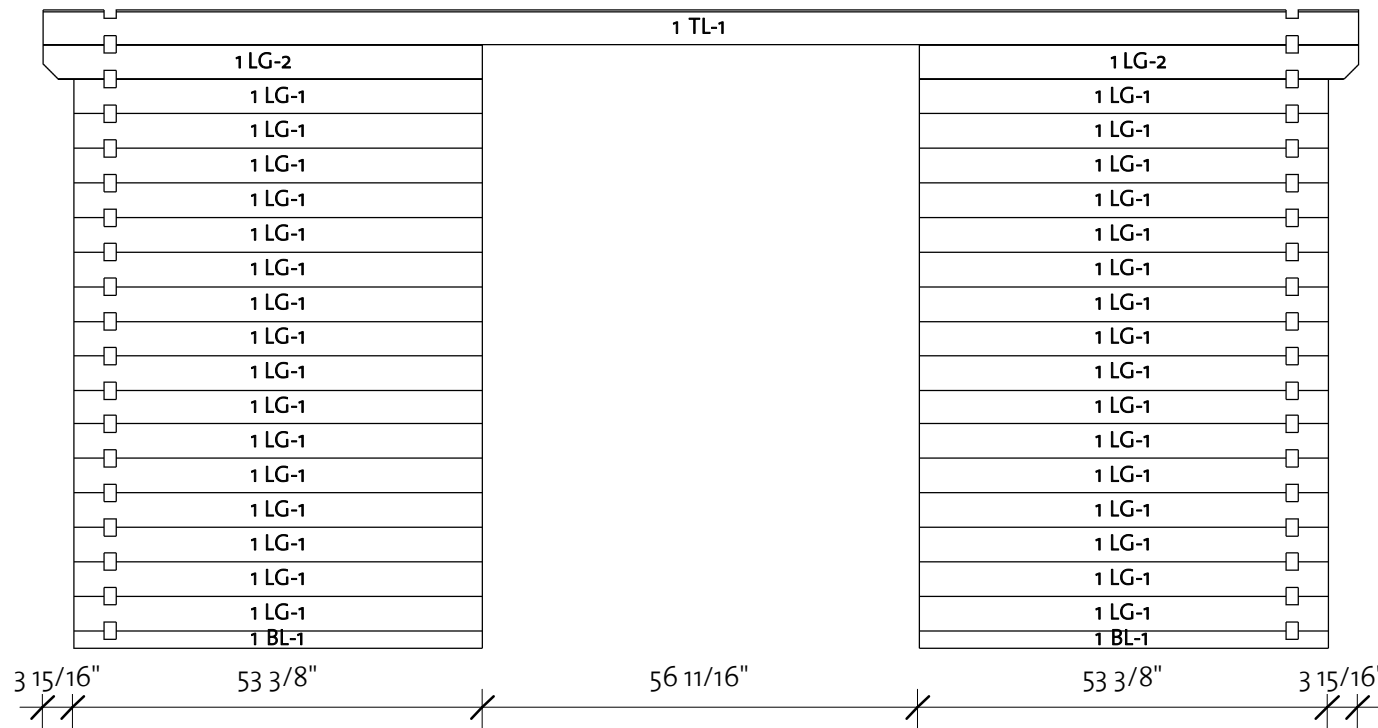

Log Profile Wall 1	
Profile	Profile

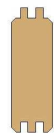
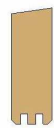
4OX57	
4OX114	
4OX114	

Lancaster 40 (155 1/2" x 155 1/2")

Wall 2

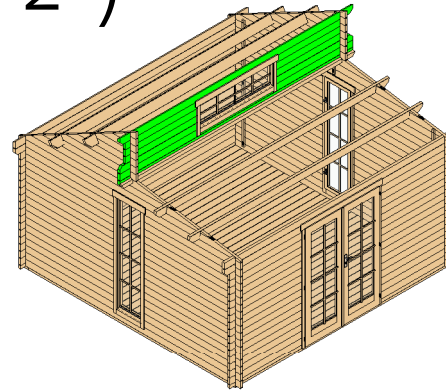

Wall 2			
Mark	Profile	Count	Cut Length

2LG-1	40X114	6	53 1/4"
2LG-2	40X114	2	57 3/16"
2LG-3	40X114	1	171 1/4"
2LG-4	40X114	1	171 1/4"
2TL-1	40X123	1	171 1/4"

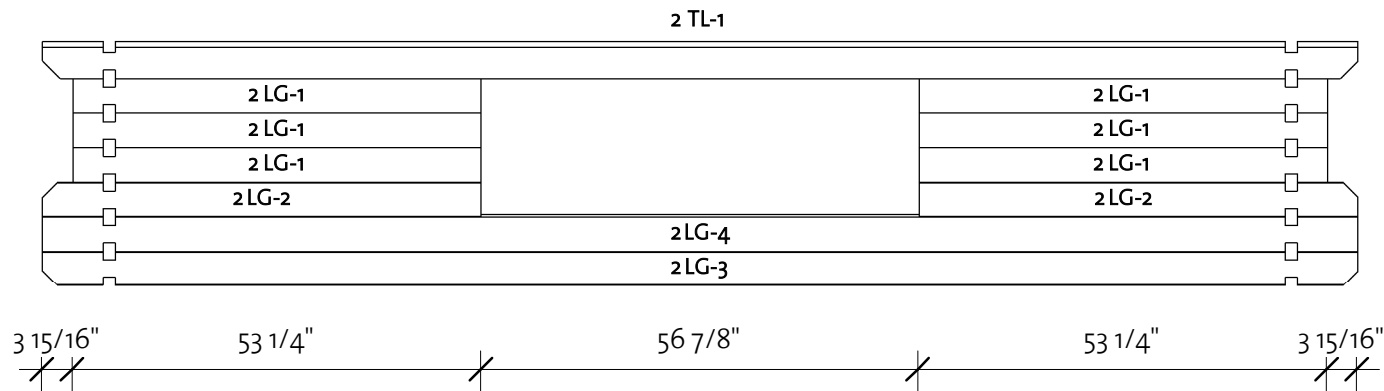

Log Profile Wall 2	
Profile	Profile

40X114	
40X123	

Lancaster 40 (155 1/2" x 155 1/2")

Wall 3

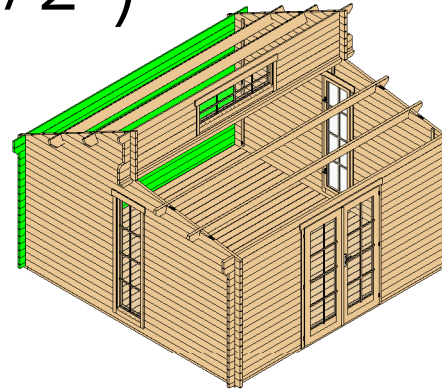

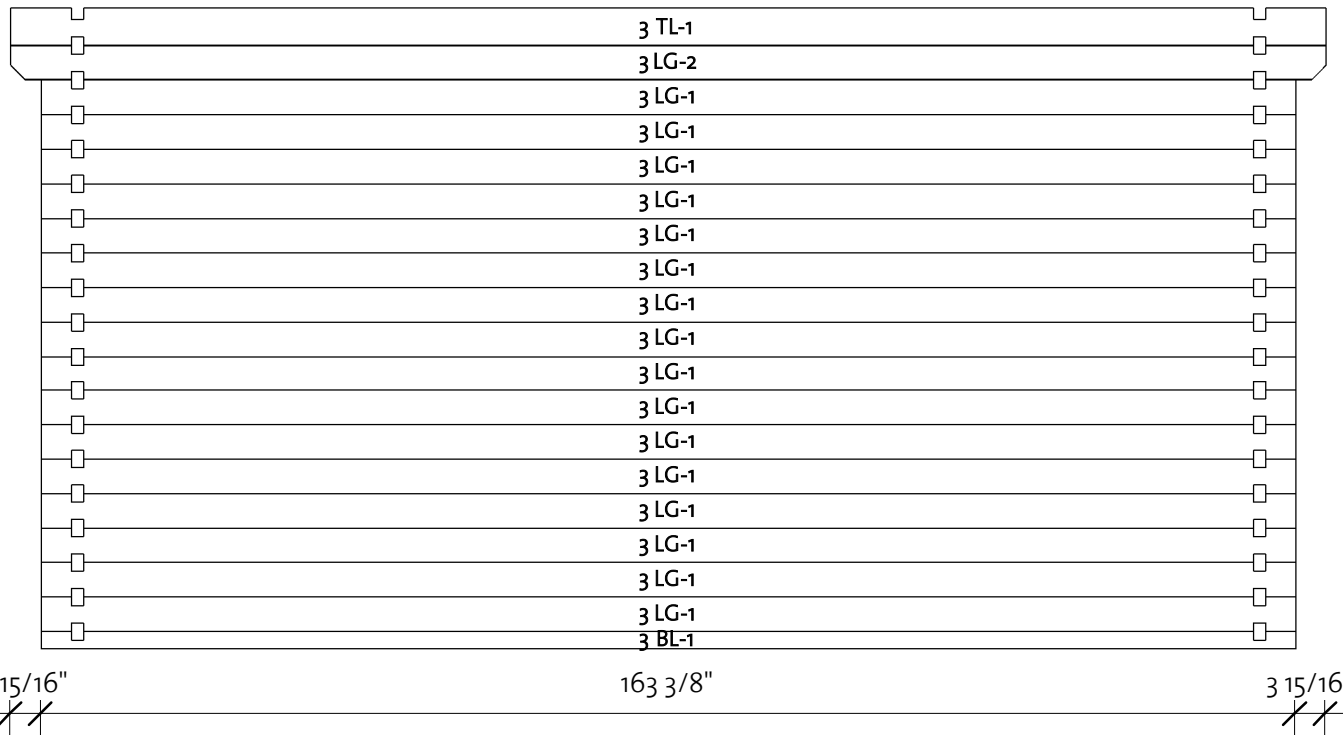

Wall 3			
Mark	Profile	Count	Cut Length

3BL-1	4OX57	1	163 3/8"
3LG-1	4OX114	16	163 3/8"
3LG-2	4OX114	1	171 1/4"
3TL-1	4OX123	1	171 1/4"

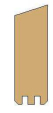

Log Profile Wall 3	
Profile	Profile

4OX57	
4OX114	
4OX123	

Lancaster 40 (155 1/2" x 155 1/2")

Wall A

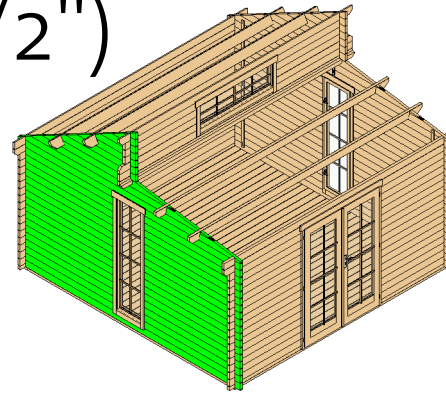

Wall A			
Mark	Profile	Count	Cut Length

ALG-1	* 40x114	1	8 7/8"
ALG-2	* 40x114	1	17 7/16"
ALG-3	* 40x114	1	26"
ALG-4	* 40x114	1	34 9/16"
ALG-5	* 40x114	1	43 1/8"
ALG-6	* 40x114	1	51 5/8"
ALG-7	40x114	33	71 7/16"
ALG-8	* 40x114	1	71 7/16"
ALG-9	* 40x114	1	97 5/16"
ALG-10	* 40x114	1	134 7/16"
ALG-11	* 40x114	1	162 13/16"
ALG-12	40x114	1	163 3/8"
ALG-13	* 40x114	1	60 3/16"

* Gable - delivered premounted

Log Profile Wall A	
Profile	Profile

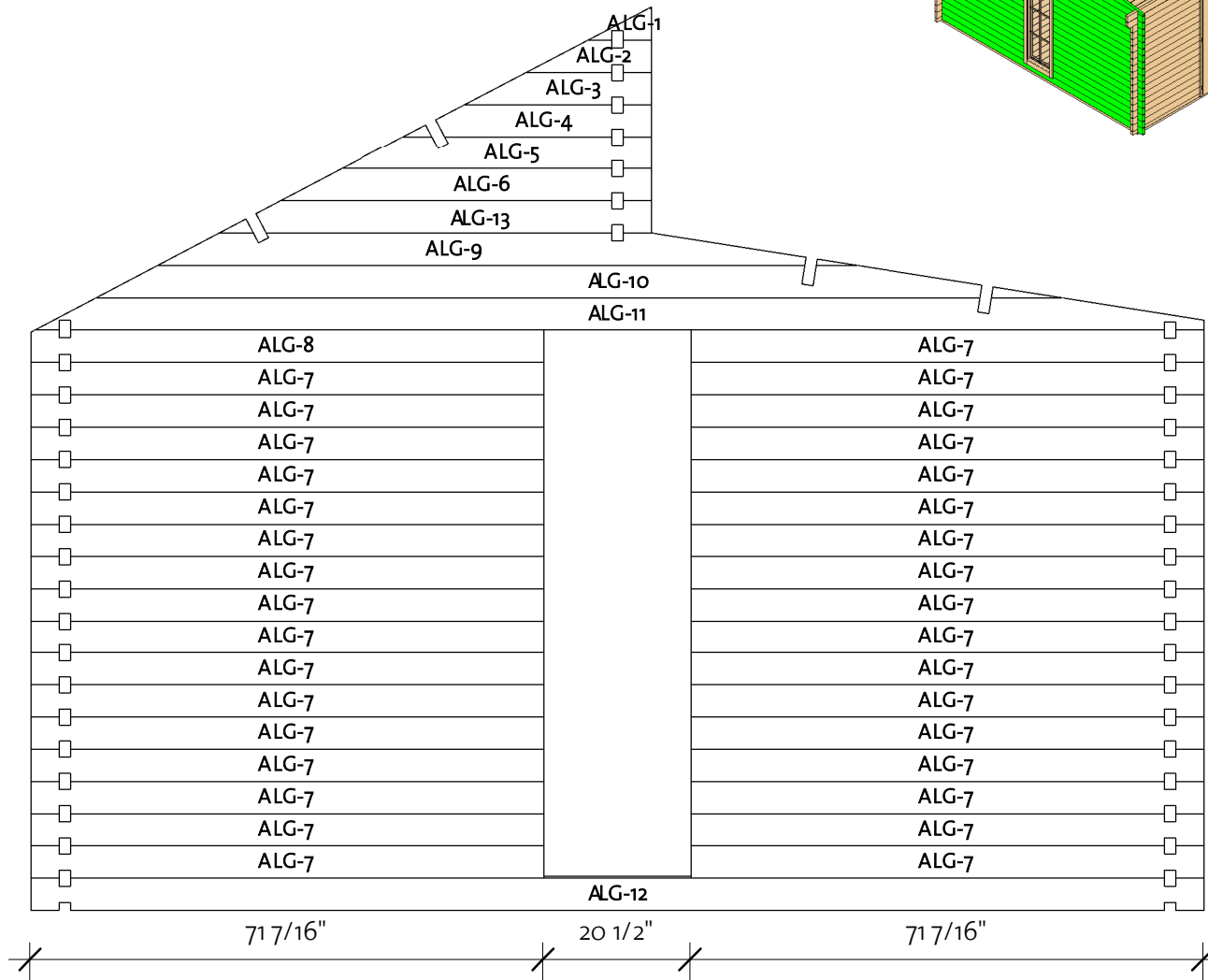
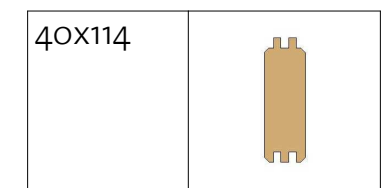

Lancaster 40 (155 1/2" x 155 1/2")

Wall B

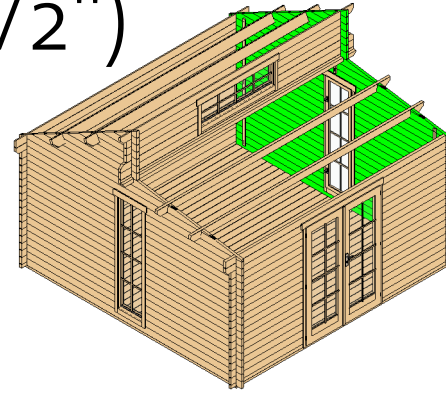

Wall B			
Mark	Profile	Count	Cut Length

BLG-1	* 4OX114	1	8 7/8"
BLG-2	* 4OX114	1	17 7/16"
BLG-3	* 4OX114	1	26"
BLG-4	* 4OX114	1	34 9/16"
BLG-5	* 4OX114	1	43 1/8"
BLG-6	* 4OX114	1	51 5/8"
BLG-7	4OX114	33	71 7/16"
BLG-8	* 4OX114	1	71 7/16"
BLG-9	* 4OX114	1	97 5/16"
BLG-10	* 4OX114	1	134 7/16"
BLG-11	* 4OX114	1	162 13/16"
BLG-12	4OX114	1	163 3/8"
BLG-13	* 4OX114	1	60 3/16"

* Gable - delivered premounted

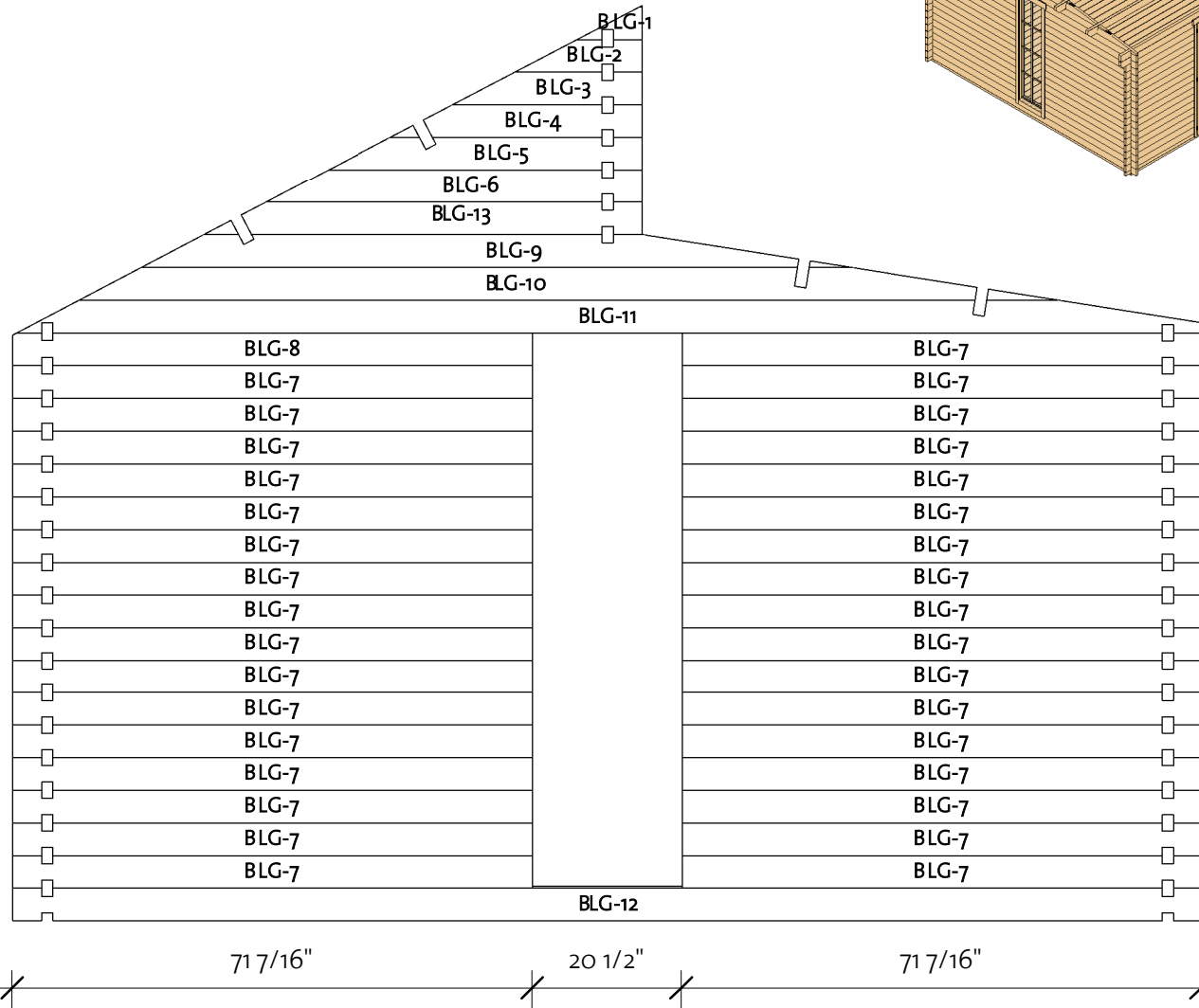
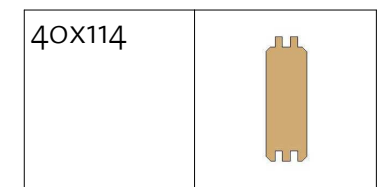

Log Profile Wall B	
Profile	Profile

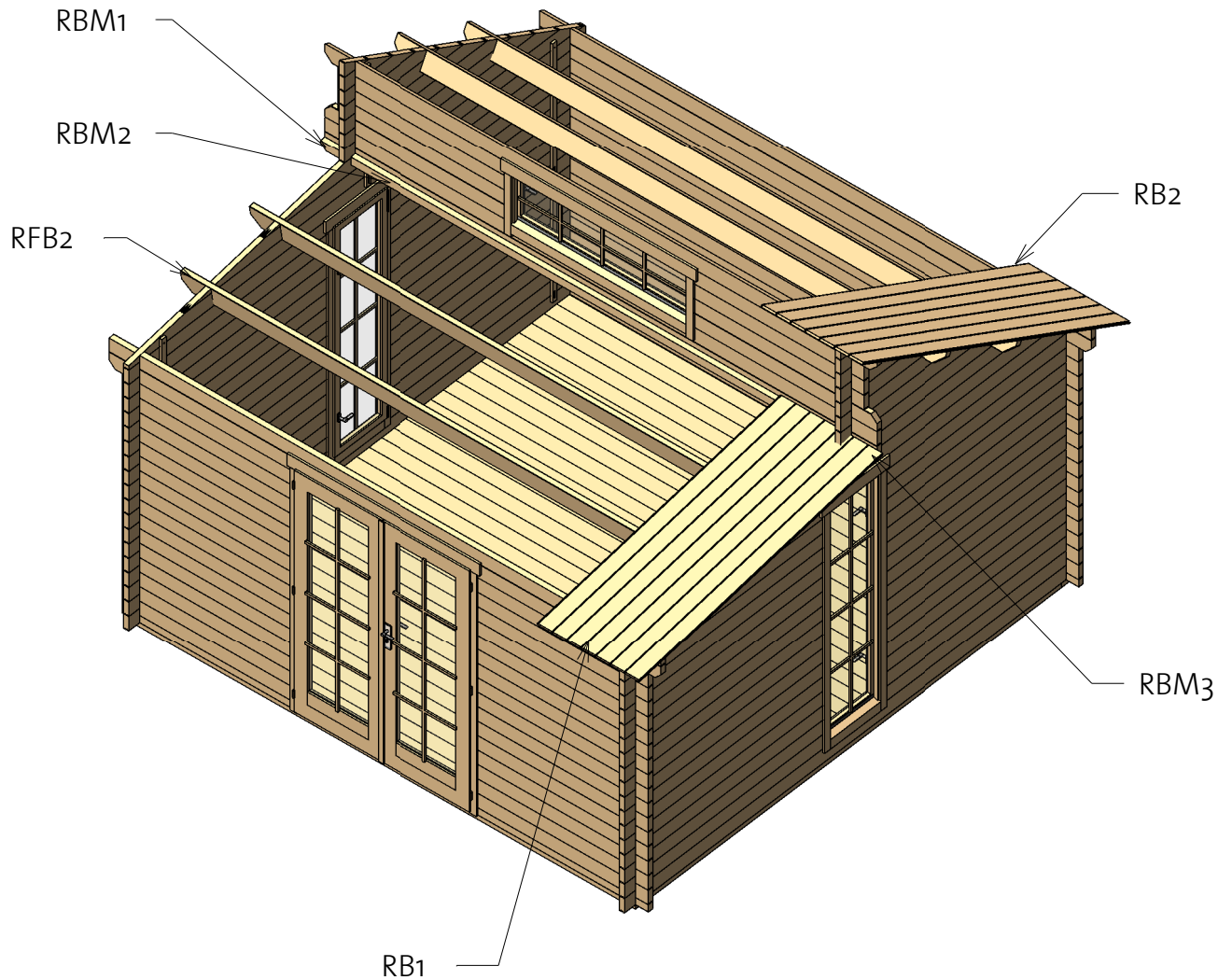

Lancaster 40 (155 1/2" x 155 1/2")

Roof 1



Roof				
Mark	Type	Profile	Count	Length
RB1	17x114		39	87 7/8"
RB2	17x114		39	108 3/16"
RBM1	Beam 40x70		1	7 7/8"
RBM2	Beam 40x70		1	152 3/8"
RBM3	Beam 40x70		1	7 7/8"
RFB	Beam 40x143		4	171 1/4"

Lancaster 40 (155 1/2" x 155 1/2")

Roof 2

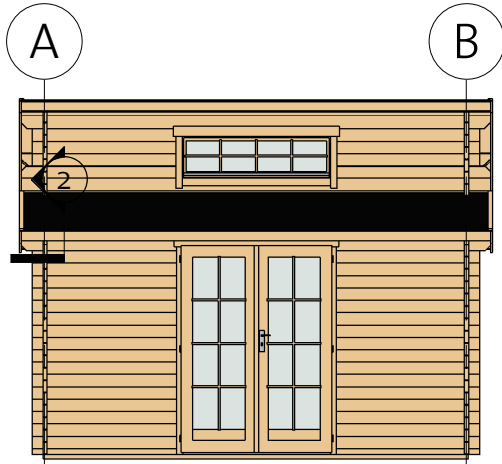

② Facia

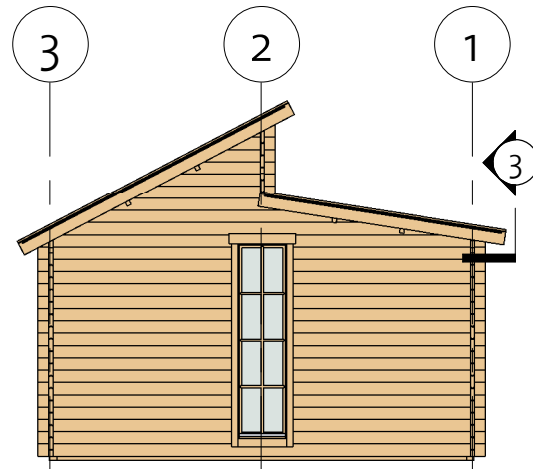
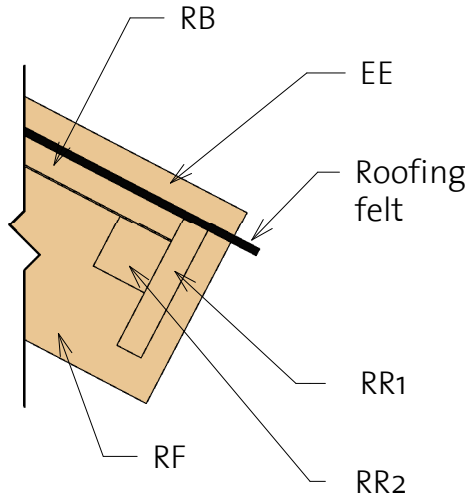

③ Roof Reinforcement

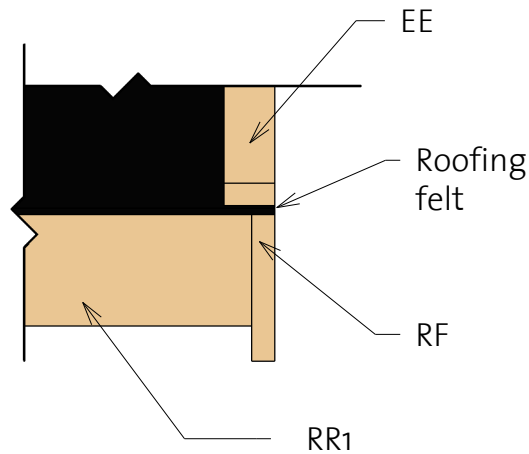

Fascia Schedule

Mark	Type	Profile	Count	Length
EE1	Eave Edging 18x40		2	89 3/8"
EE2	Eave Edging 18x40		2	111"
RF1	Roof Fascia 18x120		2	91"
RF2	Roof Fascia 18x120		2	111"
RR1	Roof reinforcement 18x95		3	171 1/4"
RR2	Roof reinforcement 38x38		3	171 1/4"

Lancaster 40 (155 1/2" x 155 1/2")

Extras

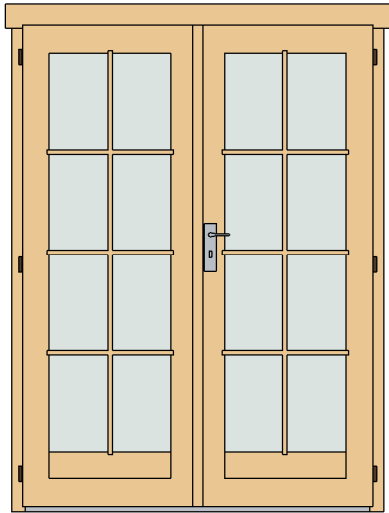

Door Schedule				
Model	Type	Width	Height	Count

CDD3R	Classic double door 3 right	56 1/8"	76 15/16"	1
-------	--------------------------------	---------	-----------	---

DCB8	Door Crossbar 8	--	--	1/16"
------	-----------------	----	----	-------

Window Schedule				
Mark	Type	Width	Height	Count

CW20R	Classic window 20 right	56 1/2"	16 9/16"	1
CW21R	Classic window 21 right	20 1/4"	74 7/16"	2

WCB8-5	Windows Crossbar 8-5	--	--	1
WCB8-6	Windows Crossbar 8-6	--	--	2

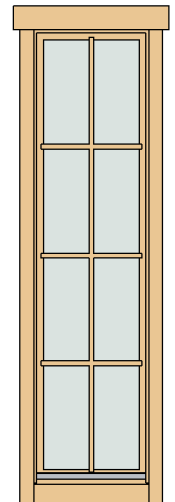
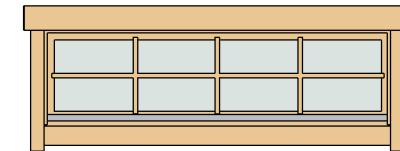

Fasteners/Extras		
Name	Type	Count

Hitblock	300-400 mm	
Bolts	M8x70	16
Screws	5,0 x 70	35
Nails	1,4 x 40	40
Screws	6,0 x 140	70
Screws	4,0 x 40	790

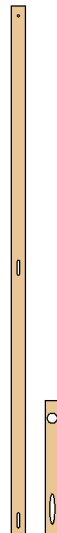

Type	Count	Length
------	-------	--------

Windboard 1 18x40	4	2200
Windboard 2 18x40	2	960

91922092_211216

Lancaster 40 (155 1/2"x155 1/2")

List of all items 1

Impregnated foundation beams				
Mark	Type	Profile	Count	Length

IFB1	IFB 70x40		2	155 1/8"
------	--------------	---	---	----------

IFB2	IFB 70x40		8	149 5/8"
------	--------------	---	---	----------

BB	BB 20x40		4	155 1/2"
----	-------------	---	---	----------

Roof				
Mark	Type	Profile	Count	Length

RB1	17x114		39	87 7/8"
-----	--------	---	----	---------

RB2	17x114		39	108 3/16"
-----	--------	--	----	-----------

RBM1	Beam 40x70		1	7 7/8"
------	---------------	---	---	--------

RBM2	Beam 40x70		1	152 3/8"
------	---------------	--	---	----------

RBM3	Beam 40x70		1	7 7/8"
------	---------------	--	---	--------

RFB	Beam 40x143		4	171 1/4"
-----	----------------	---	---	----------

91922092_211216

Floor Schedule				
Mark	Type	Profile	Count	Length

FB	FB 17x114		34	152 1/8"
----	--------------	---	----	----------

Fascia Schedule				
Mark	Type	Profile	Count	Length

EE1	Eave Edging 18x40		2	89 3/8"
-----	----------------------	--	---	---------

EE2	Eave Edging 18x40		2	111"
-----	----------------------	---	---	------

RF1	Roof Fascia 18x120		2	91"
-----	-----------------------	---	---	-----

RF2	Roof Fascia 18x120		2	111"
-----	-----------------------	---	---	------

RR1	Roof reinforcement 18x95		3	171 1/4"
-----	--------------------------------	---	---	----------

RR2	Roof reinforcement 38x38		3	171 1/4"
-----	--------------------------------	---	---	----------

Lancaster 40 (155 1/2"x155 1/2")

List of all items 2

Wall 1			
Mark	Profile	Count	Cut Length

1BL-1	40X57	2	53 3/8"
1LG-1	40X114	32	53 3/8"
1LG-2	40X114	2	57 5/16"
1TL-1	40X114	1	171 1/4"

Wall 3			
Mark	Profile	Count	Cut Length

3BL-1	40X57	1	163 3/8"
3LG-1	40X114	16	163 3/8"
3LG-2	40X114	1	171 1/4"
3TL-1	40X123	1	171 1/4"

Wall B			
Mark	Profile	Count	Cut Length

BLG-1 *	40X114	1	8 7/8"
BLG-2 *	40X114	1	17 7/16"
BLG-3 *	40X114	1	26"
BLG-4 *	40X114	1	34 9/16"
BLG-5 *	40X114	1	43 1/8"
BLG-6 *	40X114	1	51 5/8"
BLG-7	40X114	33	71 7/16"
BLG-8 *	40X114	1	71 7/16"
BLG-9 *	40X114	1	97 5/16"
BLG-10*	40X114	1	134 7/16"
BLG-11*	40X114	1	162 13/16"
BLG-12	40X114	1	163 3/8"
BLG-13*	40X114	1	60 3/16"

Wall 2			
Mark	Profile	Count	Cut Length

2LG-1	40X114	6	53 1/4"
2LG-2	40X114	2	57 3/16"
2LG-3	40X114	1	171 1/4"
2LG-4	40X114	1	171 1/4"
2TL-1	40X123	1	171 1/4"

Wall A			
Mark	Profile	Count	Cut Length



ALG-1 *	40X114	1	8 7/8"
ALG-2 *	40X114	1	17 7/16"
ALG-3 *	40X114	1	26"
ALG-4 *	40X114	1	34 9/16"
ALG-5 *	40X114	1	43 1/8"
ALG-6 *	40X114	1	51 5/8"
ALG-7	40X114	33	71 7/16"
ALG-8 *	40X114	1	71 7/16"
ALG-9 *	40X114	1	97 5/16"
ALG-10*	40X114	1	134 7/16"
ALG-11*	40X114	1	162 13/16"
ALG-12	40X114	1	163 3/8"
ALG-13*	40X114	1	60 3/16"

* Gable - delivered premounted

Lancaster 40 (155 1/2"x155 1/2")

List of all items 3

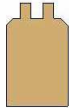
Log profiles	
Profile	Profile

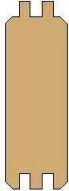
40X57	
40X123	
40X114	
40X114	