

Garage D 40 (575x510)

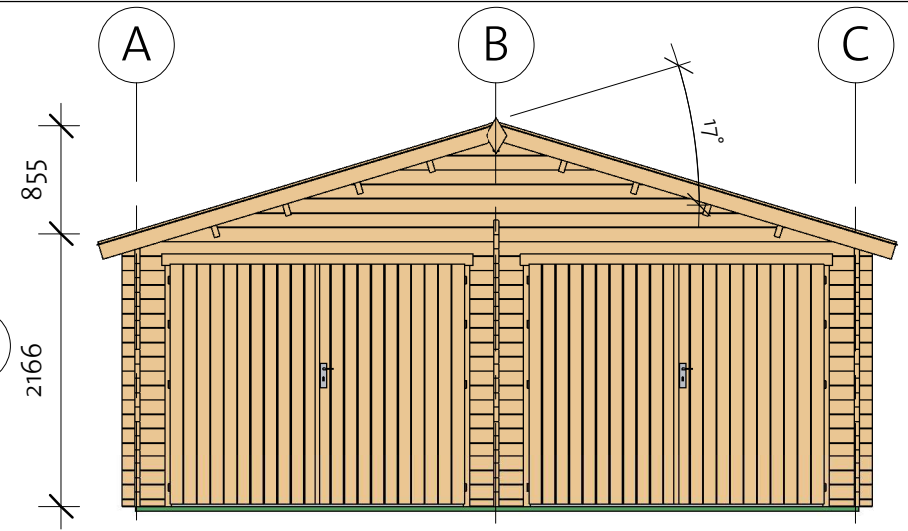

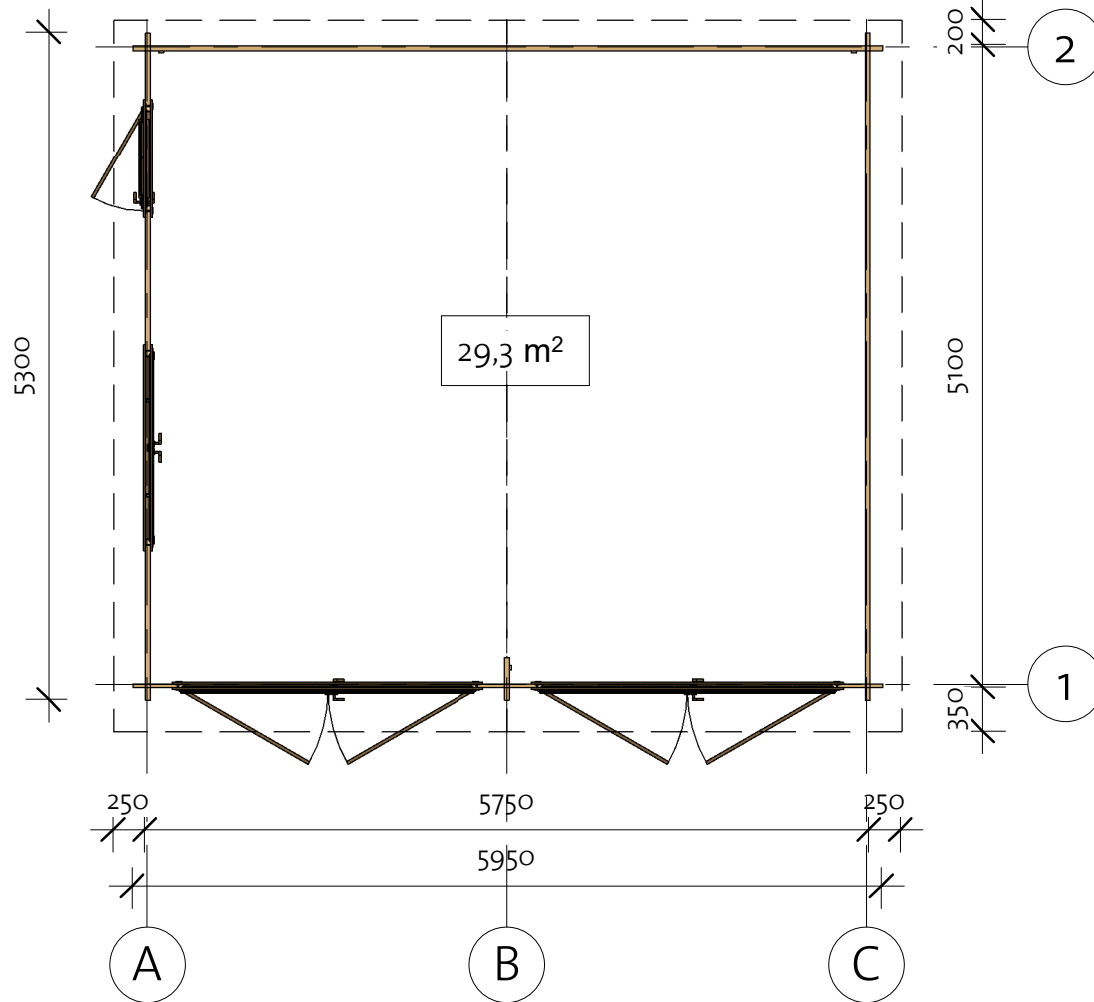
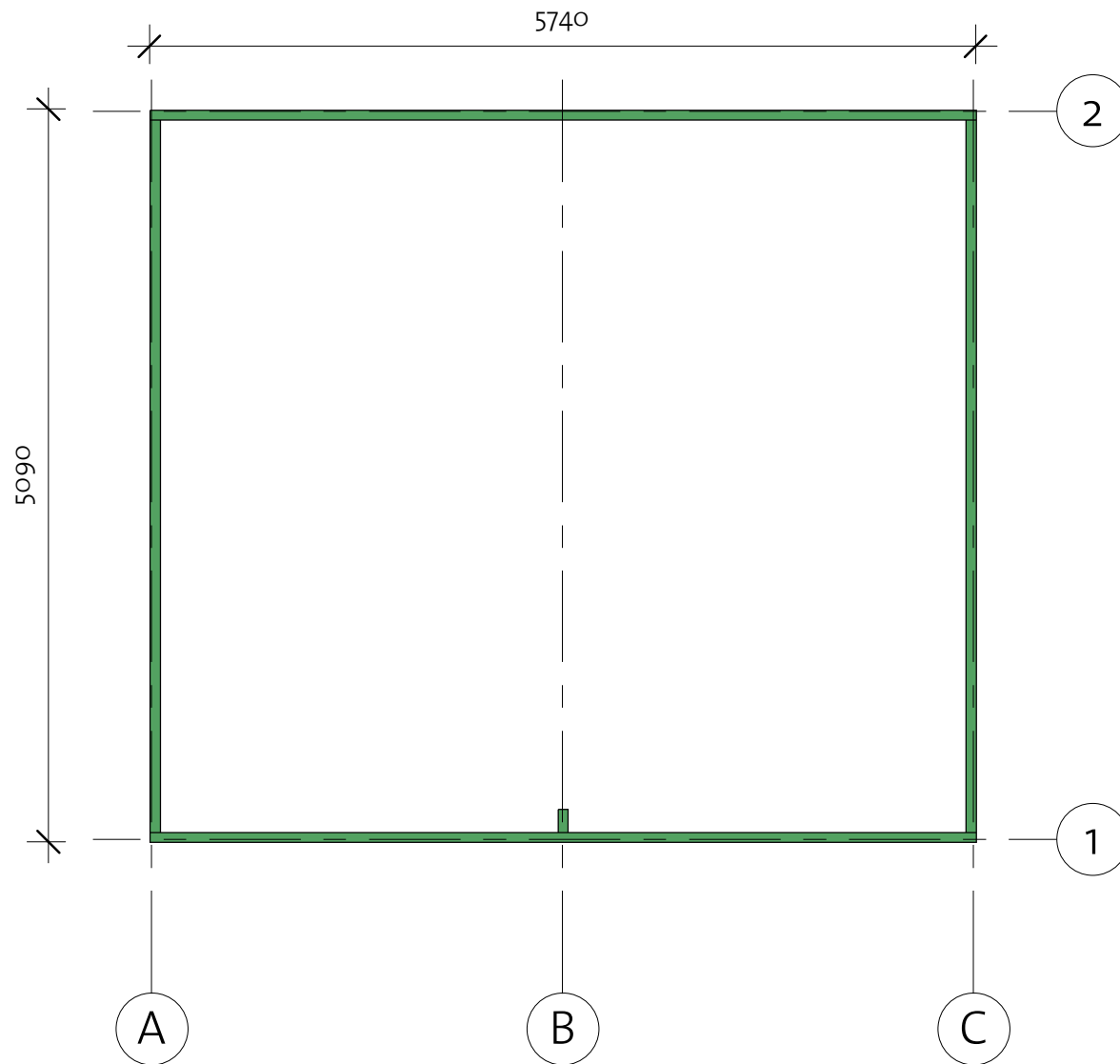

Garage D 40 (575x510)

Foundation



Impregnated foundation beams

| Mark | Type | Profile | Count | Length |
|------|------|---------|-------|--------|
|------|------|---------|-------|--------|

| | | | | |
|------|--------------|---|---|------|
| IFB1 | IFB 70x40 |  | 2 | 5740 |
| IFB2 | IFB 70x40 |  | 2 | 4950 |
| IFB3 | IFB 70x40 |  | 1 | 160 |

Garage D 40 (575x510)

Wall 1

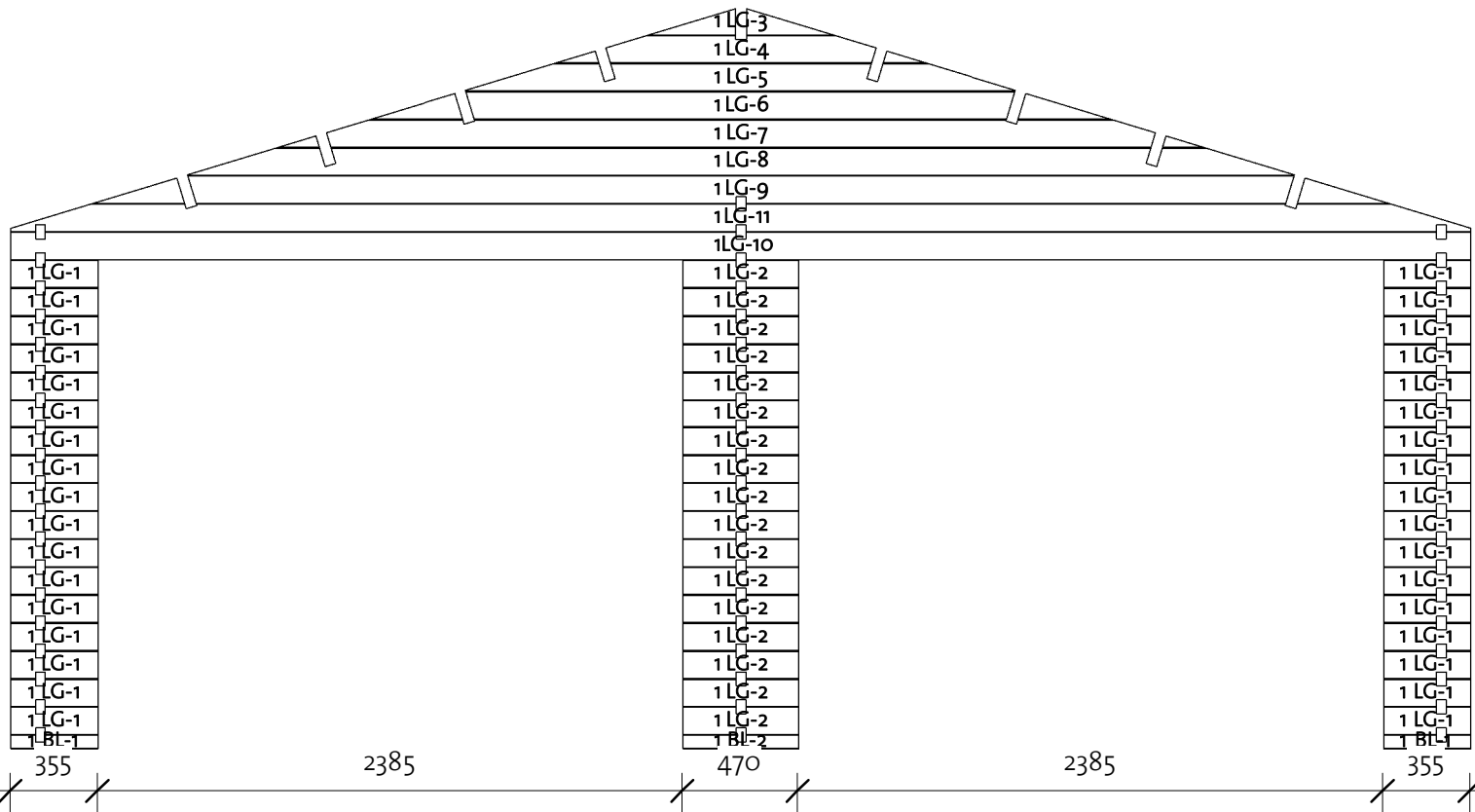
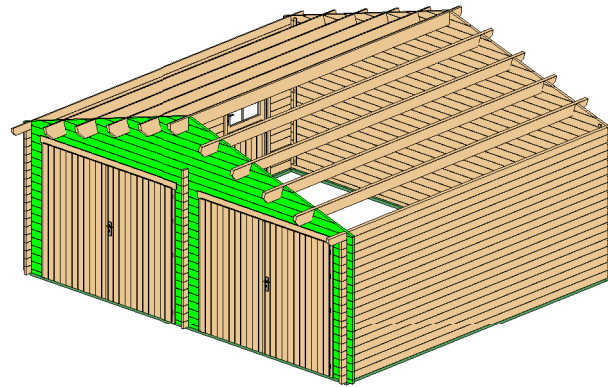

| Wall 1 | | | |
|--------|---------|-------|------------|
| Mark | Profile | Count | Cut Length |

| | | | |
|----------|--------|----|------|
| 1BL-1 | 40x57 | 2 | 355 |
| 1BL-2 | 40x57 | 1 | 470 |
| 1LG-1 | 40x114 | 34 | 355 |
| 1LG-2 | 40x114 | 17 | 470 |
| 1LG-3 * | 40x114 | 1 | 759 |
| 1LG-4 * | 40x114 | 1 | 1514 |
| 1LG-5 * | 40x114 | 1 | 2240 |
| 1LG-6 * | 40x114 | 1 | 3026 |
| 1LG-7 * | 40x114 | 1 | 3781 |
| 1LG-8 * | 40x114 | 1 | 4513 |
| 1LG-9 * | 40x114 | 1 | 5292 |
| 1LG-10 | 40x114 | 1 | 5950 |
| 1LG-11 * | 40x114 | 1 | 5950 |

* Gable - delivered premounted

| Log Profile Wall 1 | |
|--------------------|---------|
| Profile | Profile |

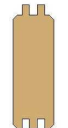
| | |
|--------|---|
| 40x57 |  |
| 40x114 |  |

Garage D 40 (575x510)

Wall 2

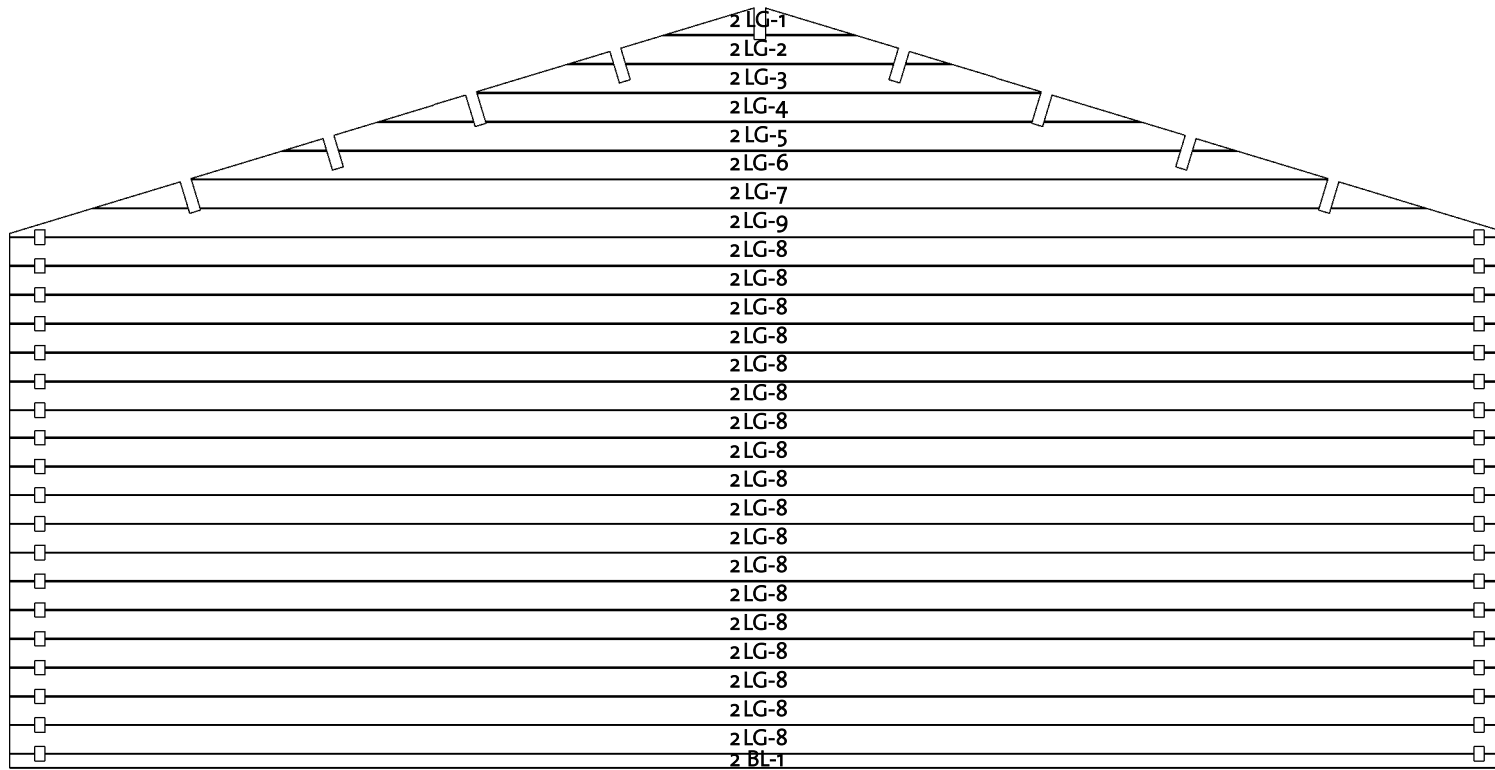
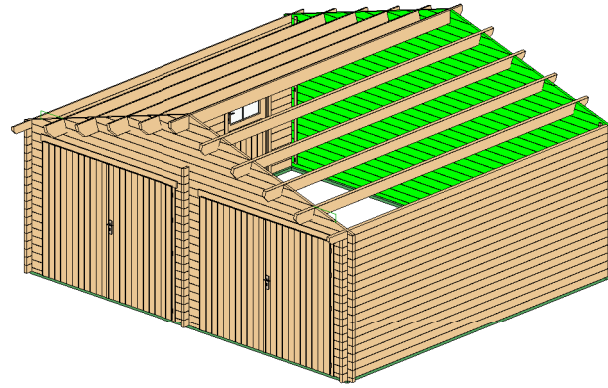



| Wall 2 | | | |
|--------|---------|-------|------------|
| Mark | Profile | Count | Cut Length |

| | | | |
|--------|--------|----|------|
| 2BL-1 | 40x57 | 1 | 5950 |
| 2LG-1* | 40x114 | 1 | 759 |
| 2LG-2* | 40x114 | 1 | 1514 |
| 2LG-3* | 40x114 | 1 | 2240 |
| 2LG-4* | 40x114 | 1 | 3026 |
| 2LG-5* | 40x114 | 1 | 3781 |
| 2LG-6* | 40x114 | 1 | 4513 |
| 2LG-7* | 40x114 | 1 | 5292 |
| 2LG-8 | 40x114 | 18 | 5950 |
| 2LG-9* | 40x114 | 1 | 5950 |

* Gable - delivered premounted

| Log Profile Wall 2 | |
|--------------------|---------|
| Profile | Profile |

| | |
|--------|---|
| 40x57 |  |
| 40x114 |  |

Garage D 40 (575x510)

Wall A

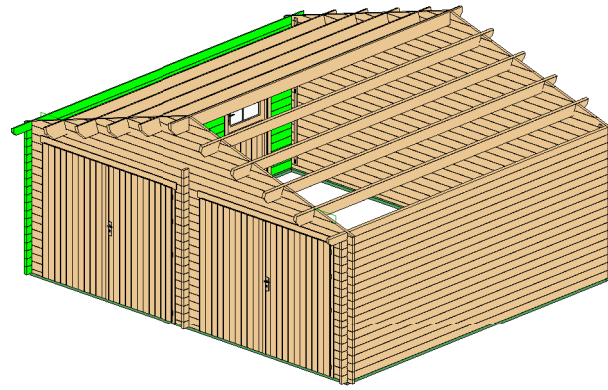

| Wall A | | | |
|--------|---------|-------|------------|
| Mark | Profile | Count | Cut Length |

| | | | |
|-------|--------|----|------|
| ALG-1 | 40X114 | 17 | 575 |
| ALG-2 | 40X114 | 9 | 1098 |
| ALG-3 | 40X114 | 9 | 1238 |
| ALG-4 | 40X114 | 8 | 3875 |
| ALG-5 | 40X114 | 1 | 5300 |
| ATL-1 | 40X114 | 1 | 5650 |

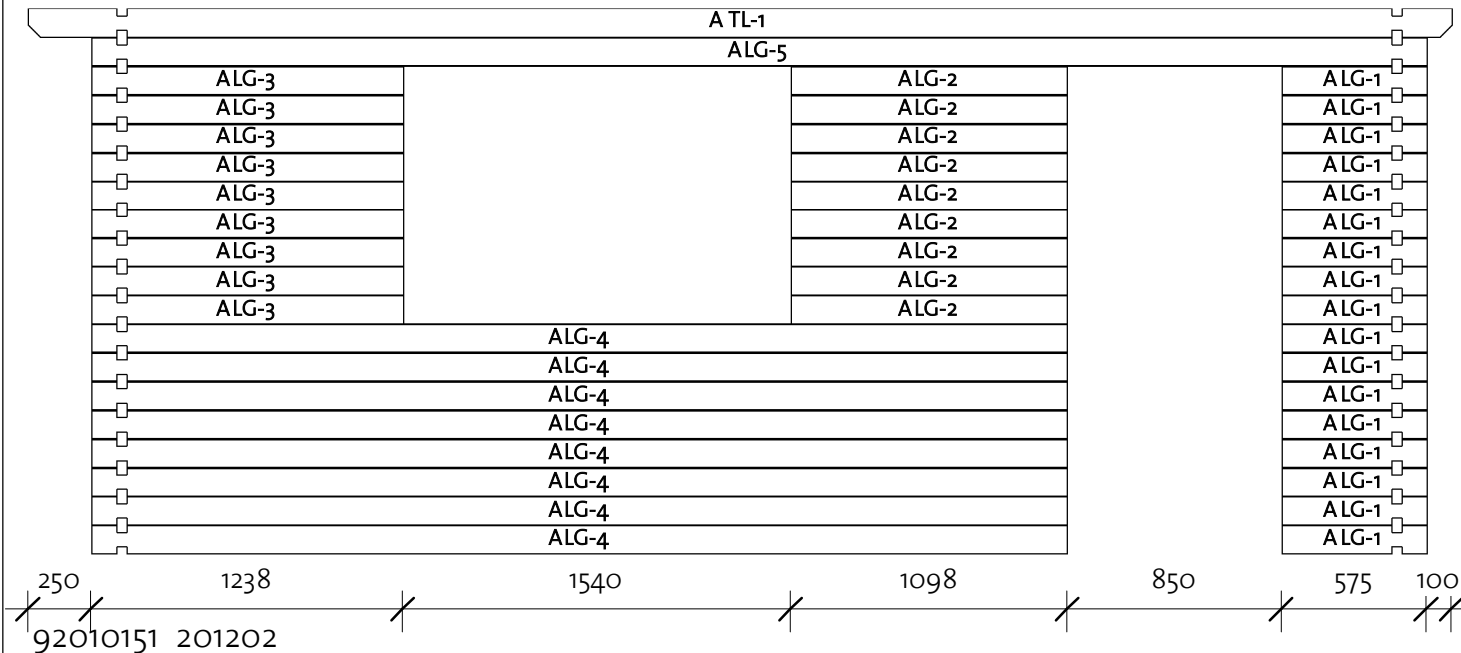



| Log Profile Wall A | |
|--------------------|---------|
| Profile | Profile |

| | |
|--------|--|
| 40X114 | |
| 40X114 | |

Garage D 40 (575x510)

Wall B / C

| Log Profile Wall B | |
|--------------------|---------|
| Profile | Profile |

| | |
|--------|---|
| 40X114 |  |
| 40X114 |  |

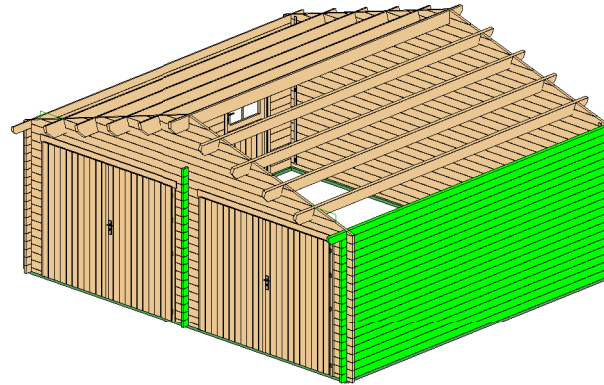

| Wall C | | | |
|--------|---------|-------|------------|
| Mark | Profile | Count | Cut Length |



| | | | |
|-------|--------|----|------|
| CLG-1 | 40X114 | 18 | 5300 |
| CTL-1 | 40X114 | 1 | 5650 |

| Wall B | | | |
|--------|---------|-------|------------|
| Mark | Profile | Count | Cut Length |

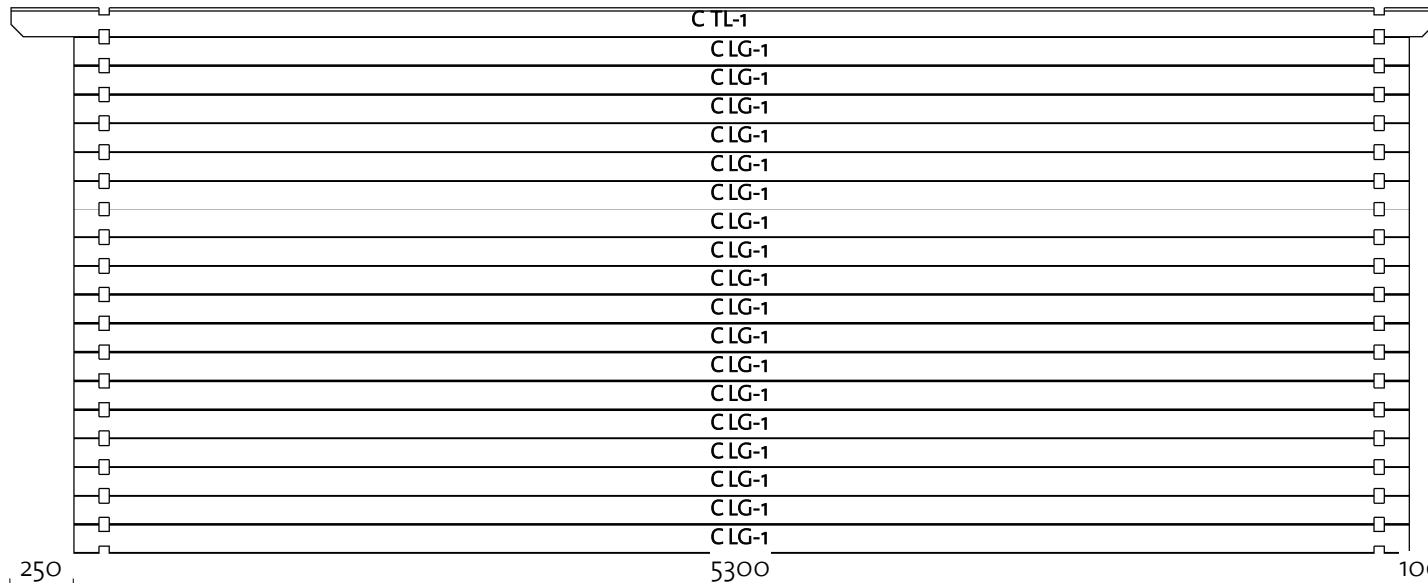
| | | | |
|-------|--------|----|-----|
| BLG-1 | 40X114 | 19 | 350 |
| BLG-2 | 40X114 | 1 | 350 |



| Log Profile Wall C | |
|--------------------|---------|
| Profile | Profile |

| | |
|--------|---|
| 40X114 |  |
| 40X114 |  |



250

100

Garage D 40 (575x510)

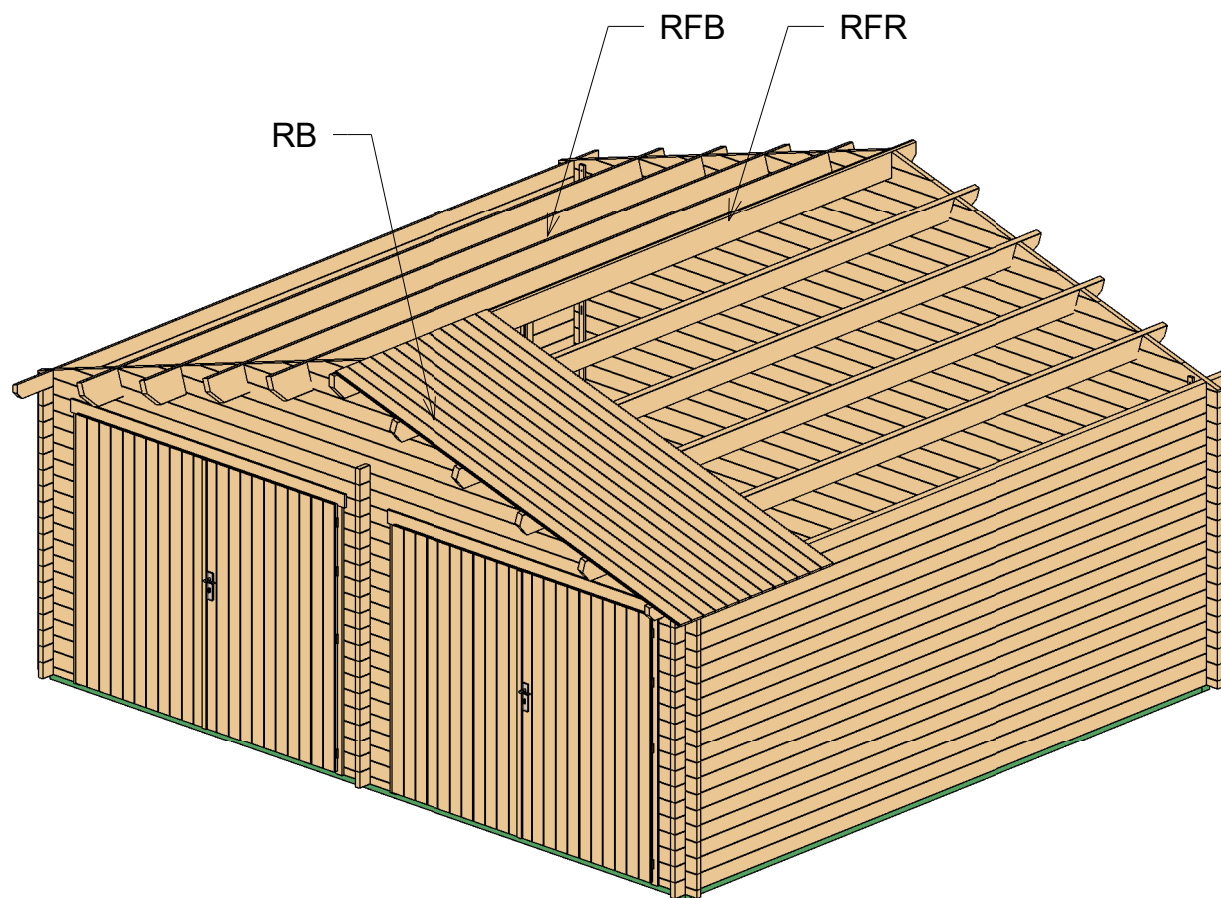
Roof 1



| Roof | | | | |
|------|-----------------|---|-------|--------|
| Mark | Type | Profile | Count | Length |
| RFR | Ridge 45x195 |  | 1 | 5650 |
| RFB | Beam 45x195 |  | 8 | 5650 |
| RB | 17x114 |  | 102 | 3259 |

Garage D 40 (575x510)

Roof 2

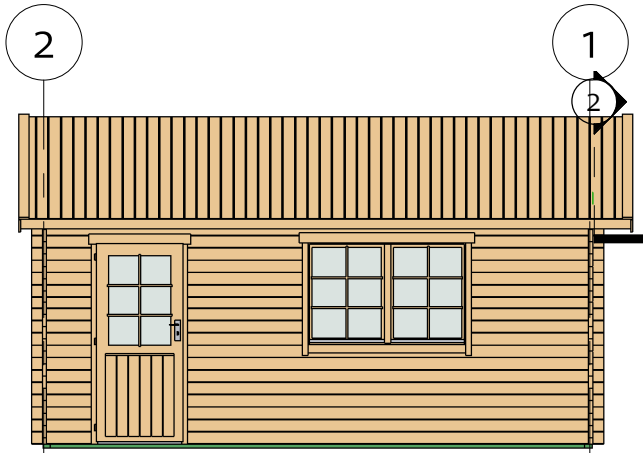

② Facia

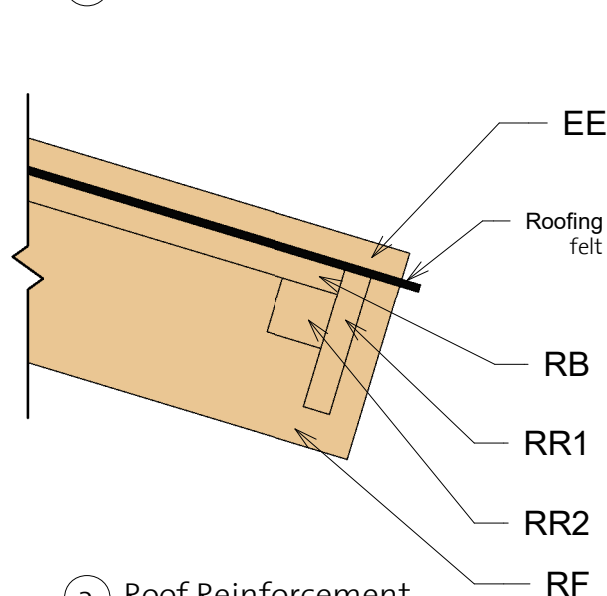

③ Roof Reinforcement

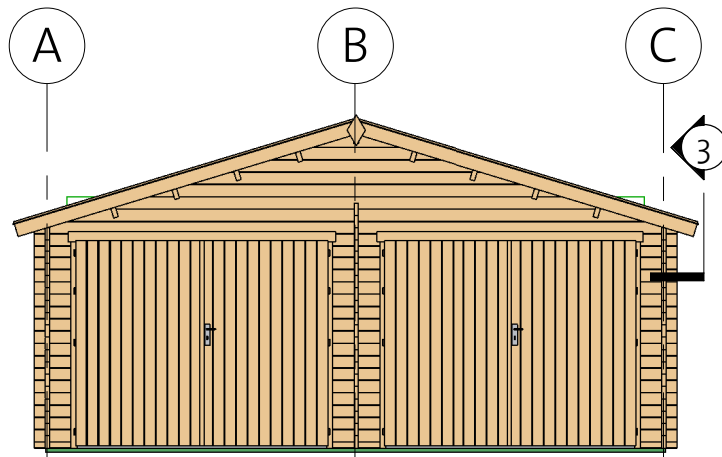
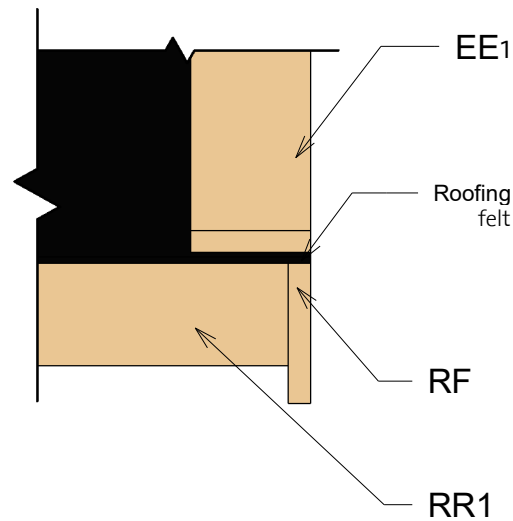

| Fascia Schedule | | | | |
|-----------------|------|---------|-------|--------|
| Mark | Type | Profile | Count | Length |

| | | | | |
|-----|-----------------------------|--|---|------|
| EE | Eave Edging 18x95 | | 4 | 3302 |
| RF | Roof Fascia 18x120 | | 4 | 3302 |
| RR1 | Roof reinforcement 18x95 | | 2 | 5650 |
| RR2 | Roof reinforcement 38x38 | | 2 | 5650 |

Garage D 40 (575x510)

Extras

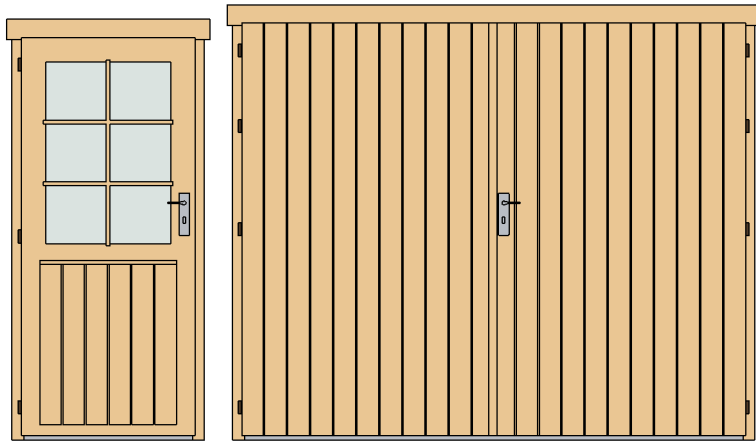







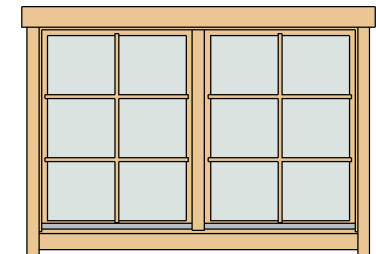

| | | | | |
|--------|---|------|------|---|
| CD1L | Classic door 1 left | 840 | 1890 | 1 |
| CDD10R | Classic double door 10, wood right | 2370 | 1955 | 2 |

| | | | | |
|------|--------------------|----|----|---|
| DCB6 | Door Crossbar 6 | -- | -- | 1 |
|------|--------------------|----|----|---|

| | | | | |
|------|----------------------------|------|-----|---|
| CDW1 | Classic double window 1 | 1530 | 990 | 1 |
|------|----------------------------|------|-----|---|

| | | | | |
|------|-----------------------|----|----|---|
| WCB6 | Windows Crossbar 6 | -- | -- | 2 |
|------|-----------------------|----|----|---|



| | | | |
|-----------|------------|---|-----|
| Hitblock | 300-400 mm |  | |
| Door bolt | 315 x 65 | | 2 |
| Screws | 5,0 x 70 |  | 15 |
| Bolts | M8x70 |  | 15 |
| Screws | 5,0 x 40 |  | 16 |
| Screws | 6,0 x 140 |  | 63 |
| Screws | 4,0 x 40 |  | 110 |
| Screws | 4,0 x 50 |  | 670 |

| Type | Count | Length |
|------|-------|--------|
|------|-------|--------|

| | | |
|--------------------|---|------|
| Windboard 18x40 | 5 | 2200 |
|--------------------|---|------|

| Type | Count |
|------|-------|
|------|-------|



| | |
|------|---|
| Romb | 2 |
|------|---|







Garage D 40 (575x510)

List of all items 1



Impregnated foundation beams

| Mark | Type | Profile | Count | Length |
|------|--------------|---|-------|--------|
| IFB1 | IFB 70x40 |  | 2 | 5740 |
| IFB2 | IFB 70x40 |  | 2 | 4950 |
| IFB3 | IFB 70x40 |  | 1 | 160 |

Fascia Schedule

| Mark | Type | Profile | Count | Length |
|------|------------------------------------|---|-------|--------|
| EE | Eave Edging 18x95 |  | 4 | 3302 |
| RF | Roof Fascia 18x120 |  | 4 | 3302 |
| RR1 | Roof reinforc ement 18x95 |  | 2 | 5650 |
| RR2 | Roof reinforc ement 38x38 |  | 2 | 5650 |

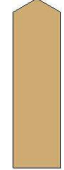
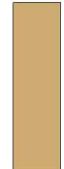
Roof

| Mark | Type | Profile | Count | Length |
|------|-----------------|---|-------|--------|
| RFR | Ridge 45x195 |  | 1 | 5650 |
| RFB | Beam 45x195 |  | 8 | 5650 |
| RB | 17x114 |  | 102 | 3259 |

Garage D 40 (575x510)

List of all items 2

| Wall 1 | | | |
|--------|---------|-------|------------|
| Mark | Profile | Count | Cut Length |

| | | | |
|----------|--------|----|------|
| 1BL-1 | 40X57 | 2 | 355 |
| 1BL-2 | 40X57 | 1 | 470 |
| 1LG-1 | 40X114 | 34 | 355 |
| 1LG-2 | 40X114 | 17 | 470 |
| 1LG-3 * | 40X114 | 1 | 759 |
| 1LG-4 * | 40X114 | 1 | 1514 |
| 1LG-5 * | 40X114 | 1 | 2240 |
| 1LG-6 * | 40X114 | 1 | 3026 |
| 1LG-7 * | 40X114 | 1 | 3781 |
| 1LG-8 * | 40X114 | 1 | 4513 |
| 1LG-9 * | 40X114 | 1 | 5292 |
| 1LG-10 | 40X114 | 1 | 5950 |
| 1LG-11 * | 40X114 | 1 | 5950 |

| Wall A | | | |
|--------|---------|-------|------------|
| Mark | Profile | Count | Cut Length |

| | | | |
|-------|--------|----|------|
| ALG-1 | 40X114 | 17 | 575 |
| ALG-2 | 40X114 | 9 | 1098 |
| ALG-3 | 40X114 | 9 | 1238 |
| ALG-4 | 40X114 | 8 | 3875 |
| ALG-5 | 40X114 | 1 | 5300 |
| ATL-1 | 40X114 | 1 | 5650 |

| Wall 2 | | | |
|--------|---------|-------|------------|
| Mark | Profile | Count | Cut Length |

| | | | |
|---------|--------|----|------|
| 2BL-1 | 40X57 | 1 | 5950 |
| 2LG-1 * | 40X114 | 1 | 759 |
| 2LG-2 * | 40X114 | 1 | 1514 |
| 2LG-3 * | 40X114 | 1 | 2240 |
| 2LG-4 * | 40X114 | 1 | 3026 |
| 2LG-5 * | 40X114 | 1 | 3781 |
| 2LG-6 * | 40X114 | 1 | 4513 |
| 2LG-7 * | 40X114 | 1 | 5292 |
| 2LG-8 | 40X114 | 18 | 5950 |
| 2LG-9 * | 40X114 | 1 | 5950 |

* Gable - delivered premounted

| Wall B | | | |
|--------|---------|-------|------------|
| Mark | Profile | Count | Cut Length |

| | | | |
|-------|--------|----|-----|
| BLG-1 | 40X114 | 19 | 350 |
| BLG-2 | 40X114 | 1 | 350 |

| Wall C | | | |
|--------|---------|-------|------------|
| Mark | Profile | Count | Cut Length |

| | | | |
|-------|--------|----|------|
| CLG-1 | 40X114 | 18 | 5300 |
| CTL-1 | 40X114 | 1 | 5650 |

| Log profiles | |
|--------------|---------|
| Profile | Profile |

| | |
|-------|---|
| 40X57 |  |
|-------|---|

| Log profiles | |
|--------------|---------|
| Profile | Profile |

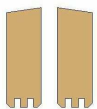
| | |
|--------|---|
| 40X114 |  |
|--------|---|

| Log profiles | |
|--------------|---------|
| Profile | Profile |

| | |
|--------|--|
| 40X114 |  |
|--------|--|

| Log profiles | |
|--------------|---------|
| Profile | Profile |

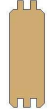
| | |
|--------|---|
| 40X114 |  |
|--------|---|