

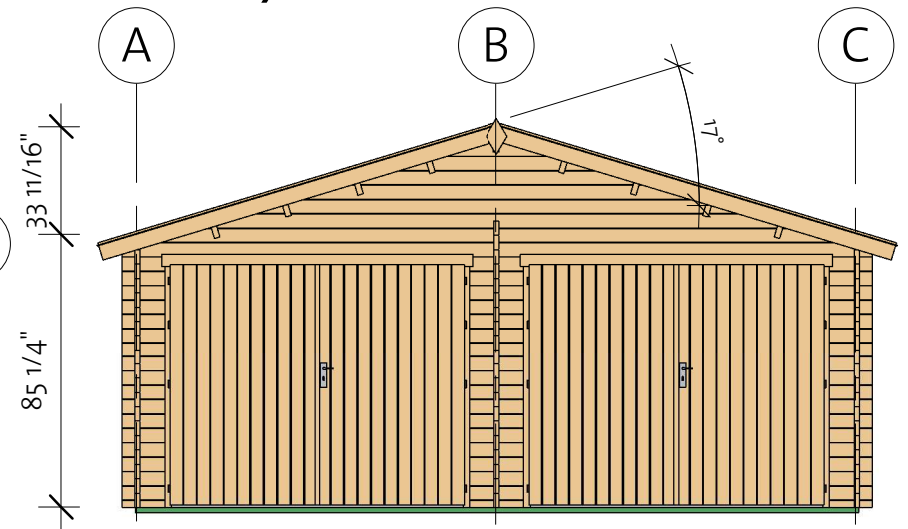

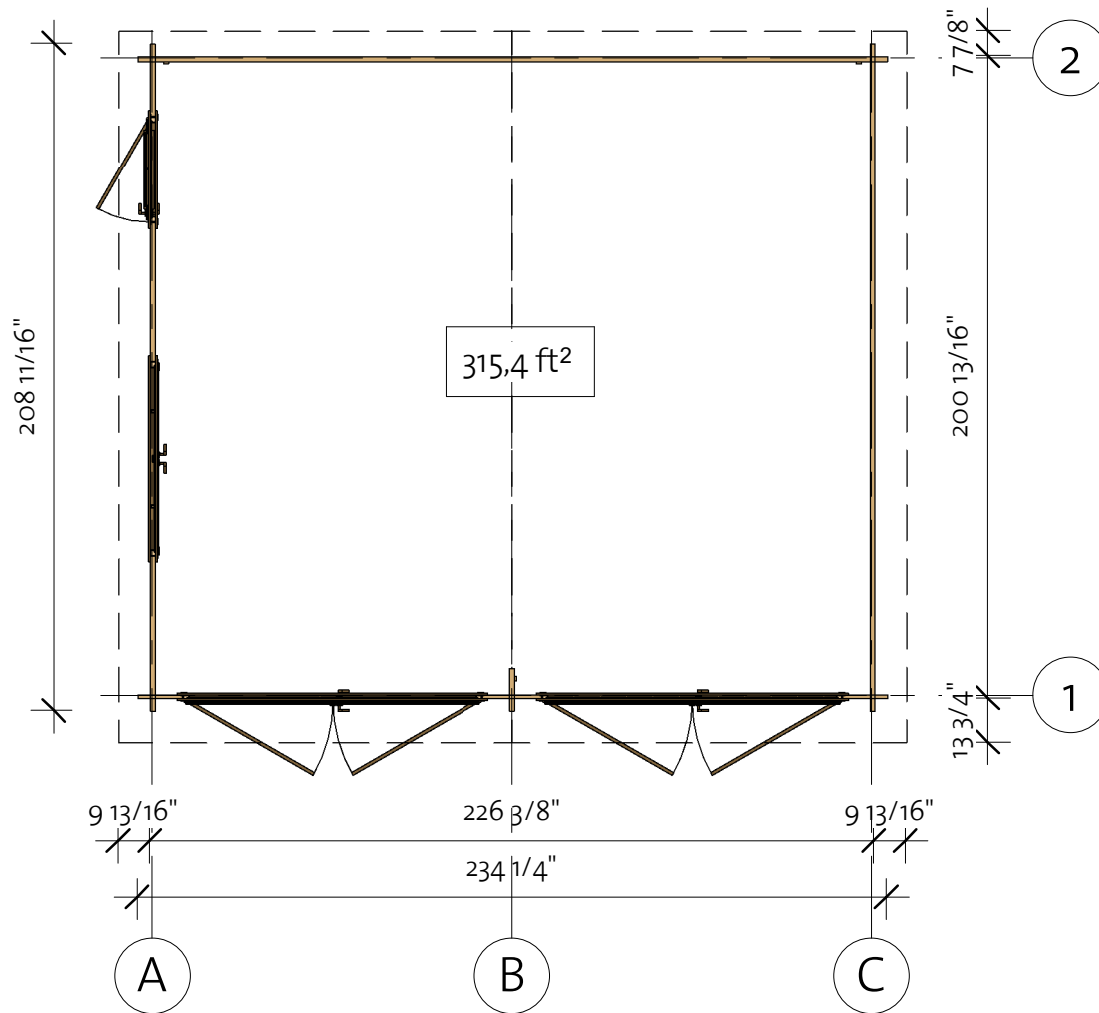

Garage D 1 9/16" (226 3/8"x20 1/16")

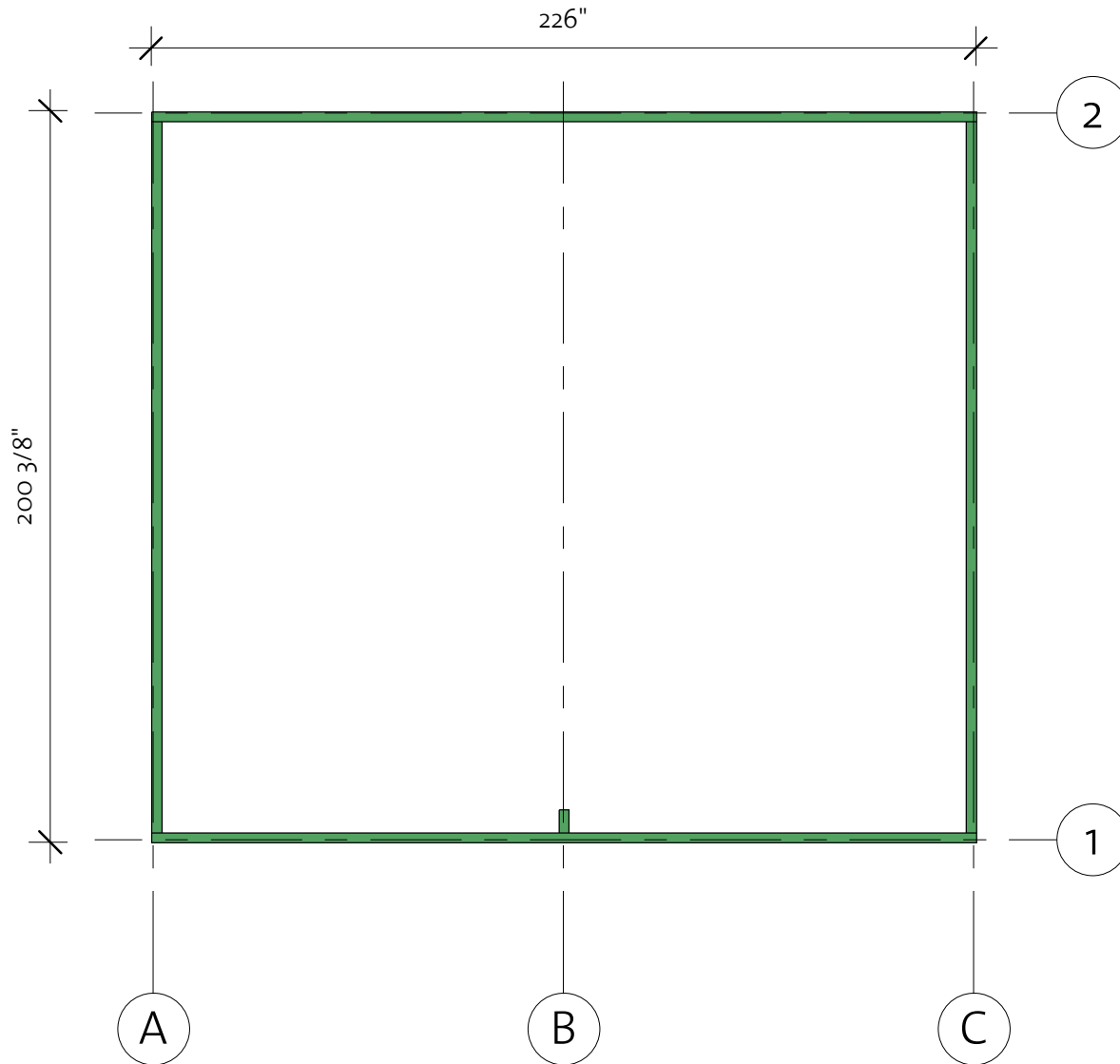

Garage D 1 9/16" (226 3/8"x20 1/16")

Foundation



Impregnated foundation beams				
Mark	Type	Profile	Count	Length
IFB1	IFB 70x40		2	226"
IFB2	IFB 70x40		2	194 7/8"
IFB3	IFB 70x40		1	6 5/16"

Garage D 1 9/16" (226 3/8"x20 1/16")

Wall 1

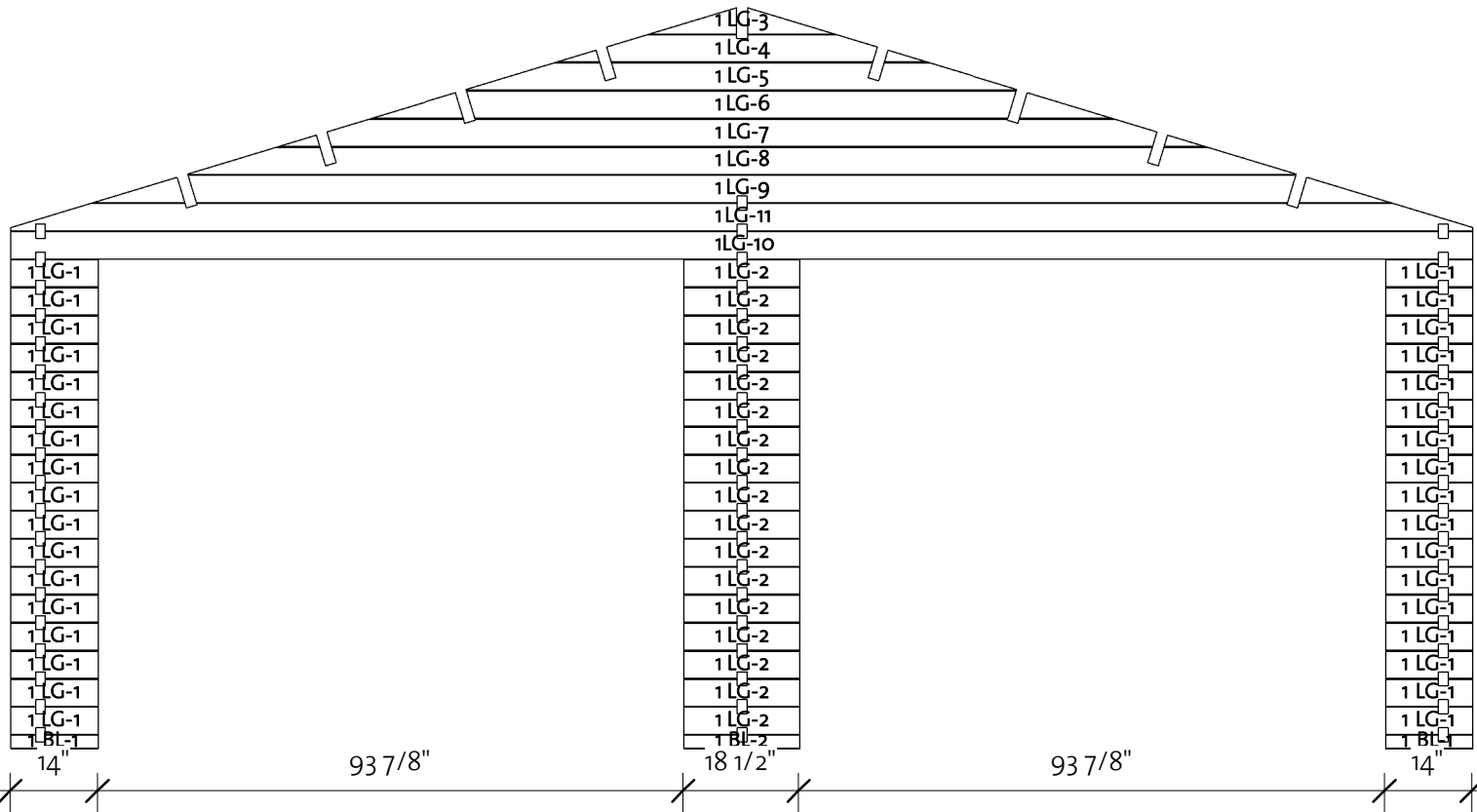
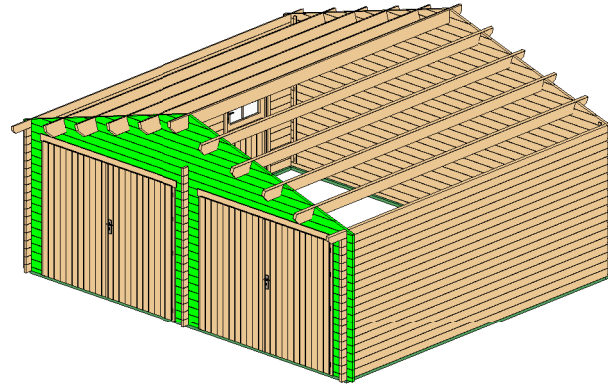

Wall 1			
Mark	Profile	Count	Cut Length

1BL-1	40X57	2	14"
1BL-2	40X57	1	18 1/2"
1LG-1	40X114	34	14"
1LG-2	40X114	17	18 1/2"
1LG-3 *	40X114	1	29 7/8"
1LG-4 *	40X114	1	59 5/8"
1LG-5 *	40X114	1	88 3/16"
1LG-6 *	40X114	1	119 1/8"
1LG-7 *	40X114	1	148 7/8"
1LG-8 *	40X114	1	177 11/16"
1LG-9 *	40X114	1	208 3/8"
1LG-10	40X114	1	234 1/4"
1LG-11 *	40X114	1	234 1/4"

* Gable - delivered premounted

Log Profile Wall 1	
Profile	Profile

40X57	
40X114	

Garage D 1 9/16" (226 3/8"x20 1/16")

Wall 2

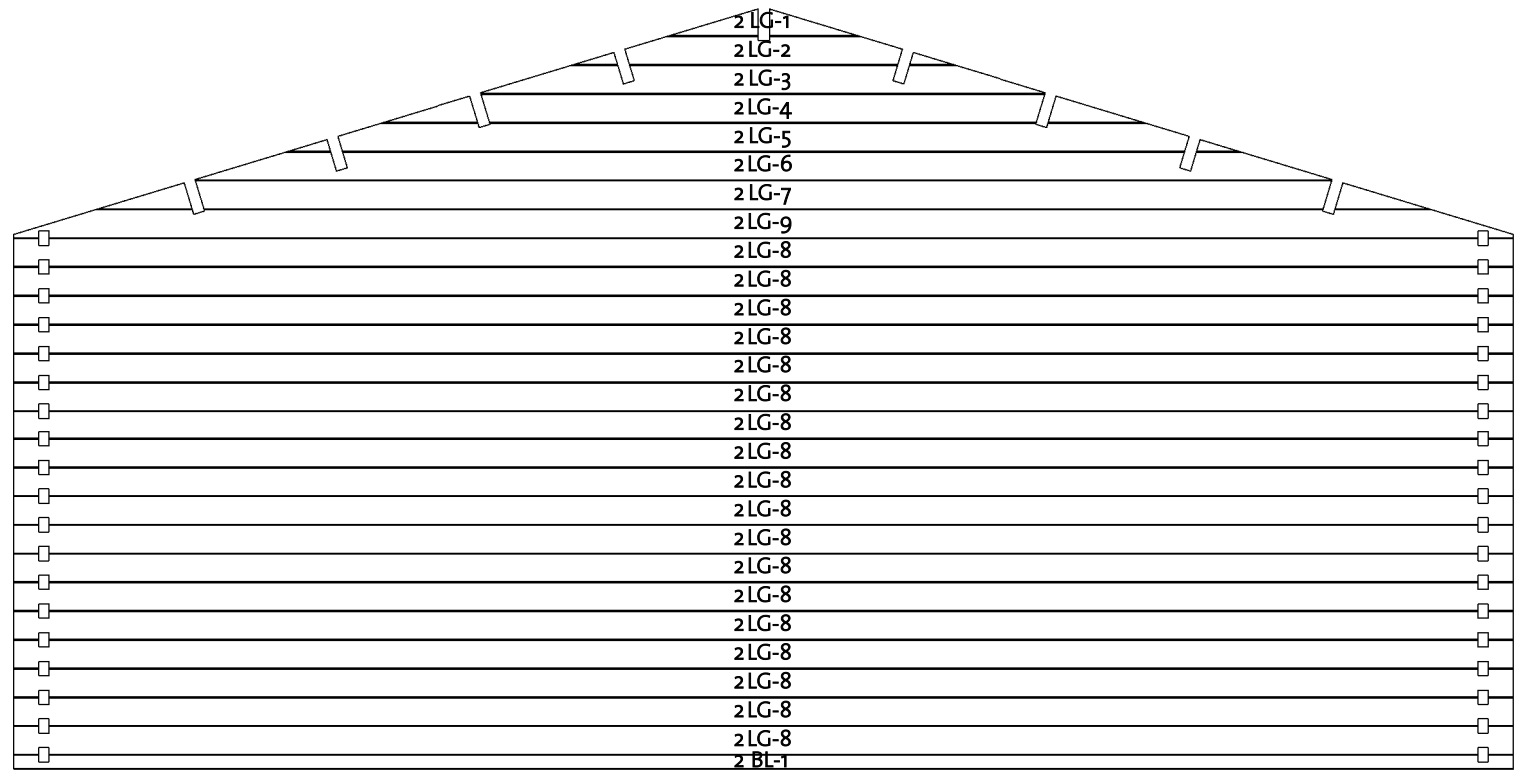
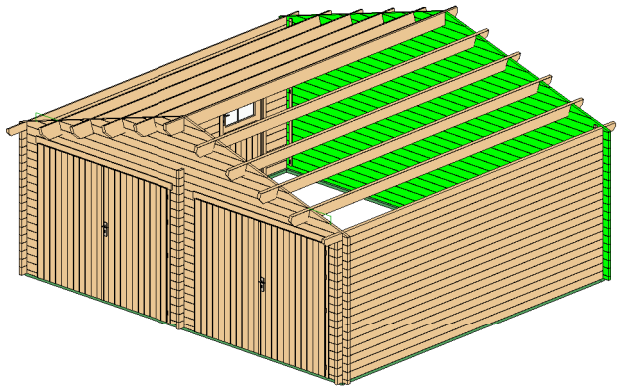

Wall 2			
Mark	Profile	Count	Cut Length

2BL-1	40X57	1	234 1/4"
2LG-1*	40X114	1	29 7/8"
2LG-2*	40X114	1	59 5/8"
2LG-3*	40X114	1	88 3/16"
2LG-4*	40X114	1	119 1/8"
2LG-5*	40X114	1	148 7/8"
2LG-6*	40X114	1	177 11/16"
2LG-7*	40X114	1	208 3/8"
2LG-8	40X114	18	234 1/4"
2LG-9*	40X114	1	234 1/4"

* Gable - delivered premounted

Log Profile Wall 2	
Profile	Profile

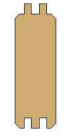
40X57	
40X114	

Garage D 1 9/16" (226 3/8"x20 1/16")

Wall A

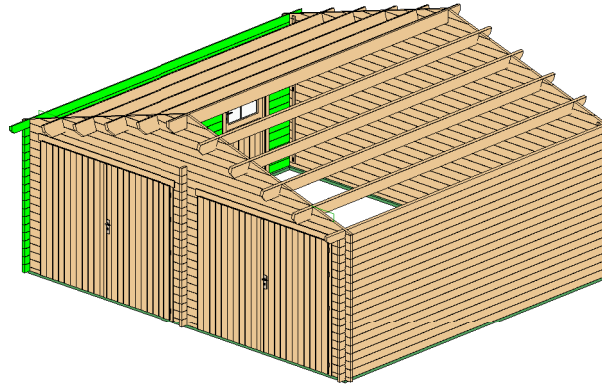

Wall A			
Mark	Profile	Count	Cut Length

ALG-1	40X114	17	22 5/8"
ALG-2	40X114	9	43 3/16"
ALG-3	40X114	9	48 3/4"
ALG-4	40X114	8	152 9/16"
ALG-5	40X114	1	208 11/16"
ATL-1	40X114	1	222 7/16"

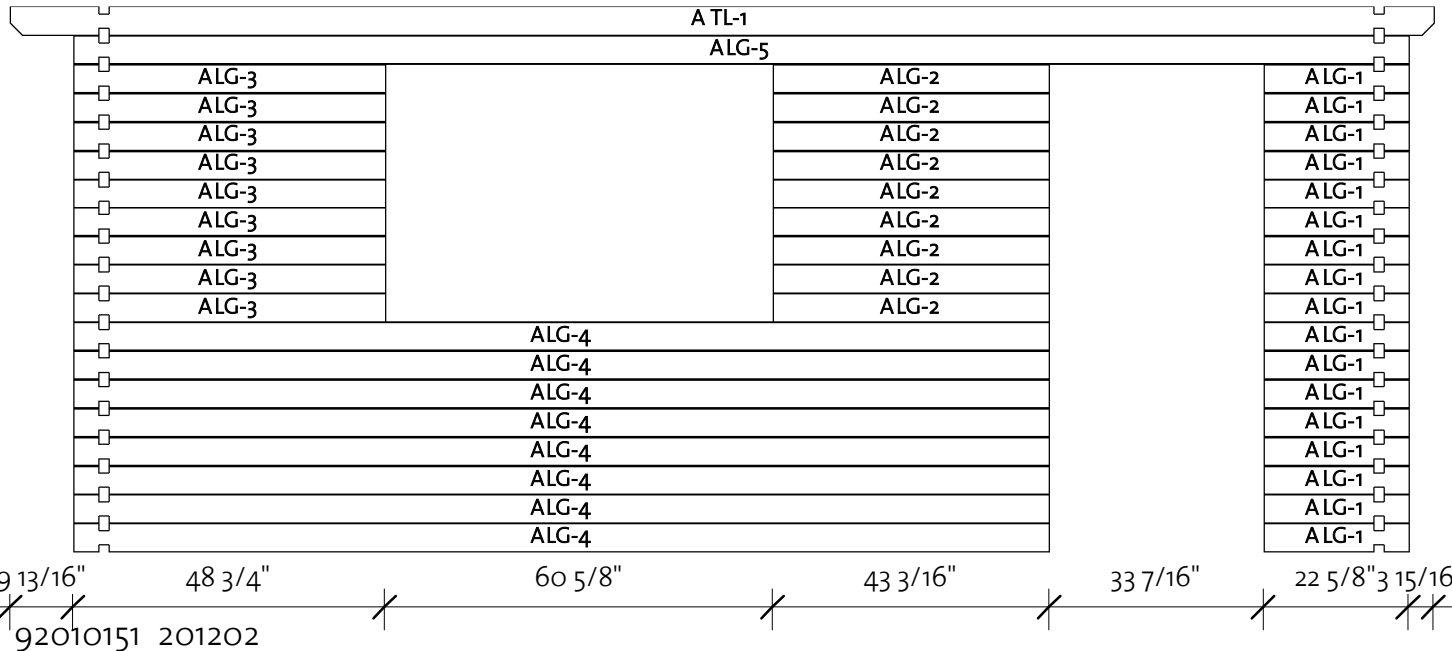



Log Profile Wall A	
Profile	Profile

40X114	
40X114	

Garage D 1 9/16" (226 3/8"x20 1/16")

Wall B / C

Log Profile Wall B	
Profile	Profile

4OX114	
4OX114	

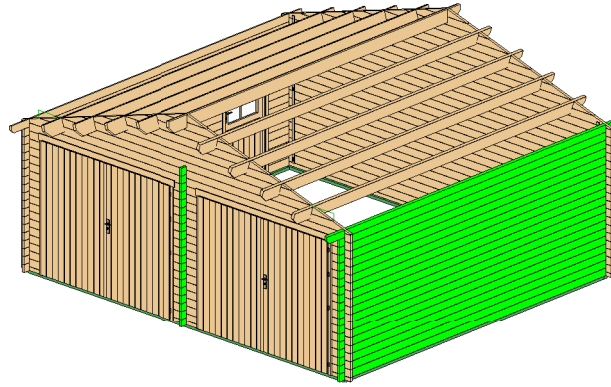

Wall C			
Mark	Profile	Count	Cut Length

CLG-1	4OX114	18	208 11/16"
CTL-1	4OX114	1	222 7/16"

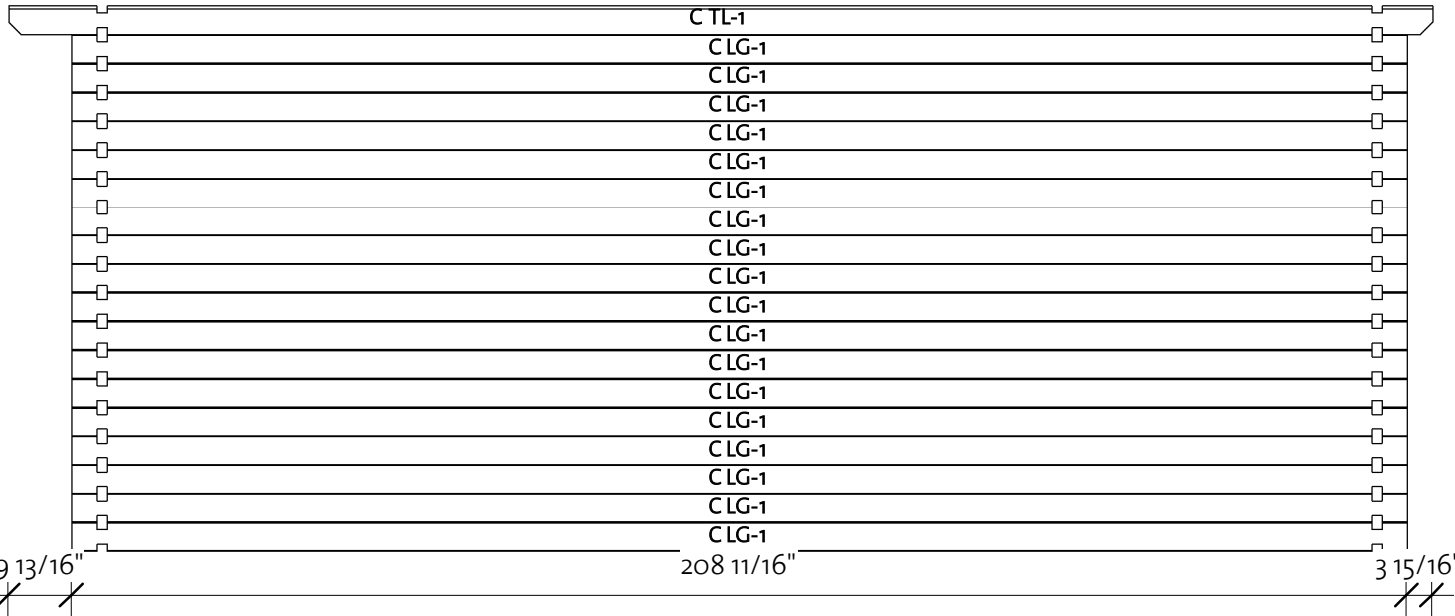

Wall B			
Mark	Profile	Count	Cut Length

BLG-1	4OX114	19	13 3/4"
BLG-2	4OX114	1	13 3/4"



- BLG-2
- BLG-1
- BLG-1
- BLG-1
- BLG-1
- BLG-1
- BLG-1
- BLG-1
- BLG-1
- BLG-1
- BLG-1
- BLG-1
- BLG-1
- BLG-1
- BLG-1
- BLG-1
- BLG-1
- BLG-1
- BLG-1



Log Profile Wall C	
Profile	Profile

4OX114	
4OX114	

Garage D 1 9/16" (226 3/8"x20 1/16")

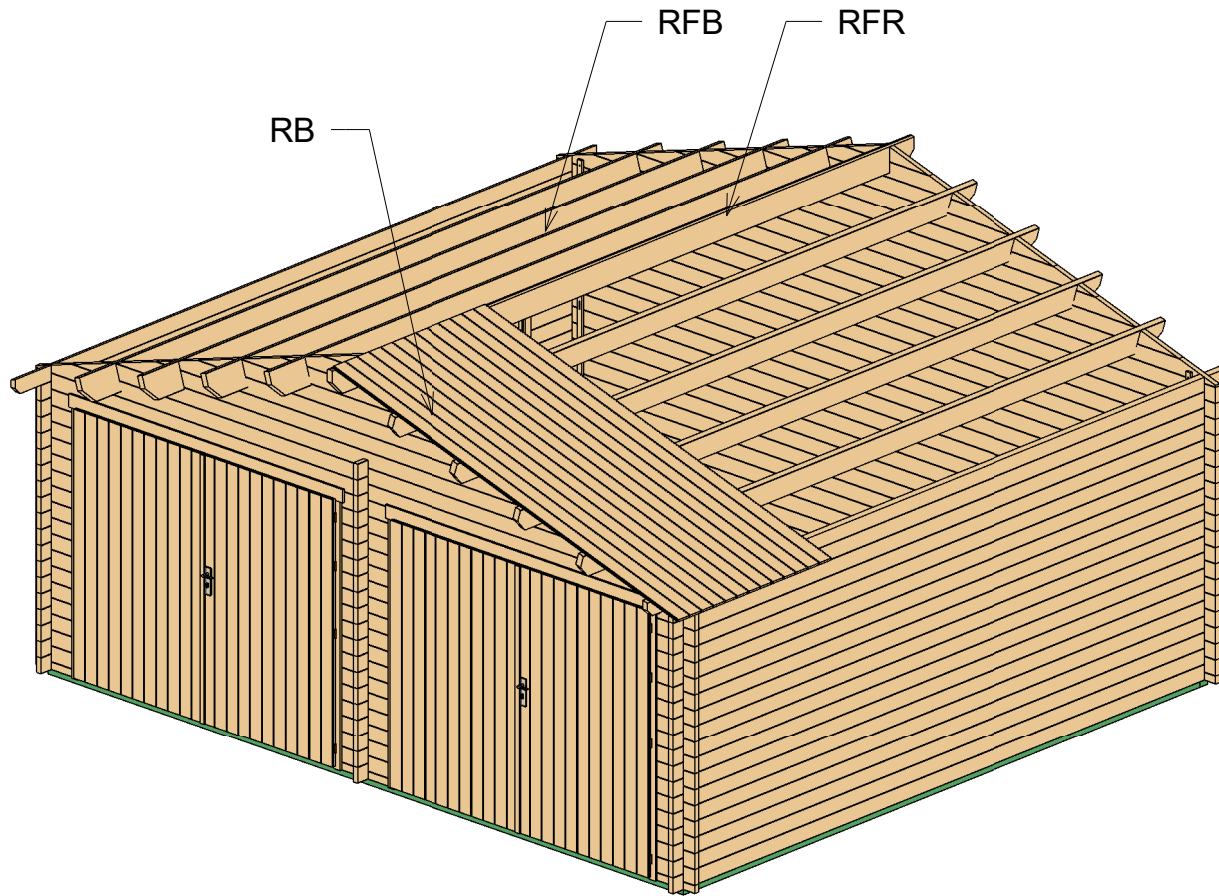
Roof 1



Roof				
Mark	Type	Profile	Count	Length
RFR	Ridge 45x195		1	222 7/16"
RFB	Beam 45x195		8	222 7/16"
RB	17x114		102	128 5/16"

Garage D 1 9/16" (226 3/8"x20 1/16")

Roof 2

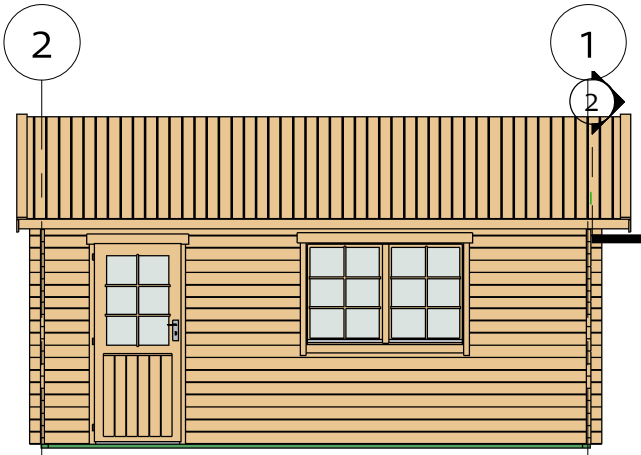

② Fascia

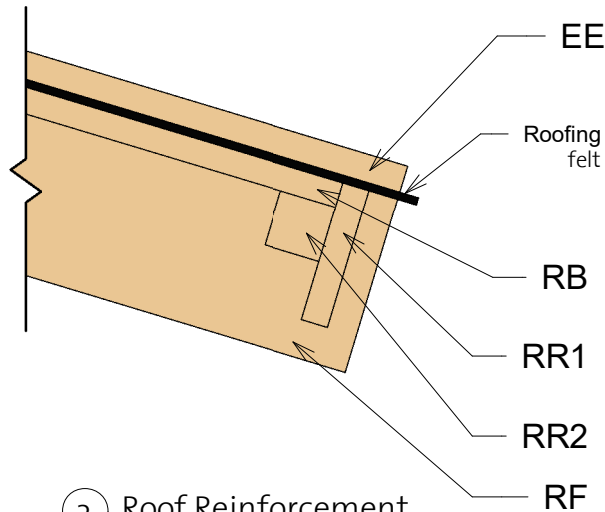

③ Roof Reinforcement

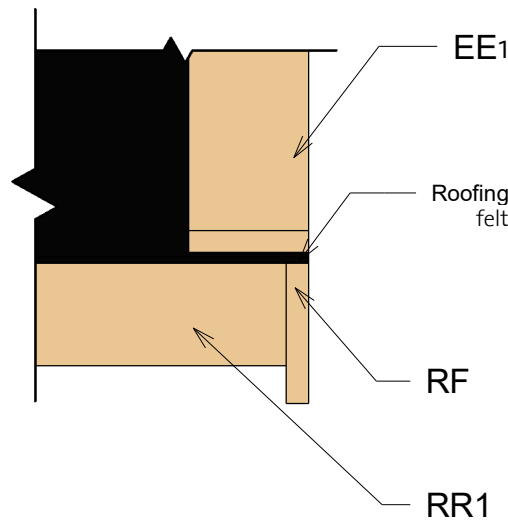
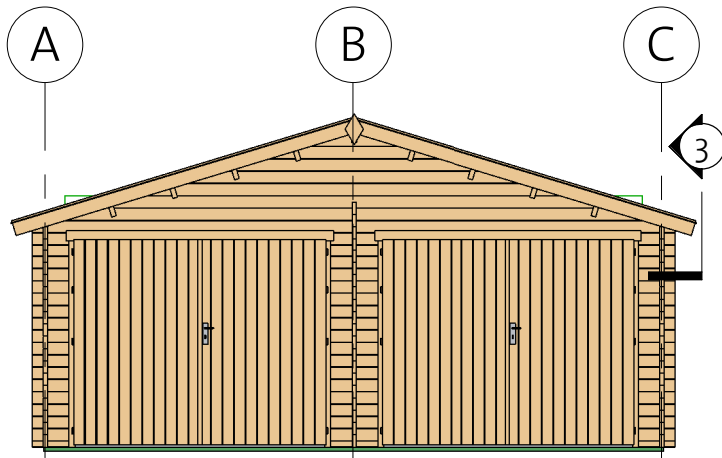

Fascia Schedule

Mark	Type	Profile	Count	Length
EE	Eave Edging 18x95		4	130"
RF	Roof Fascia 18x120		4	130"
RR1	Roof reinforcement 18x95		2	222 7/16"
RR2	Roof reinforcement 38x38		2	222 7/16"

Garage D 1 9/16" (226 3/8"x20 1/16")

Extras

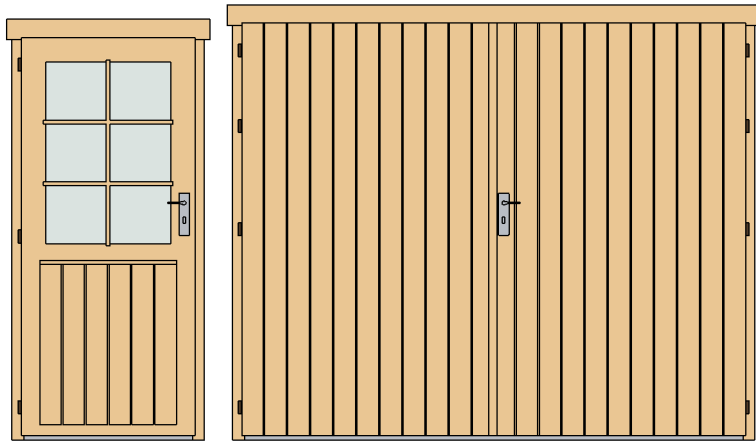







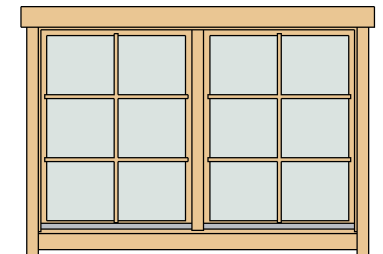

CD1L	Classic door 1 left	33 1/16"	74 7/16"	1
CDD10R	Classic double door 10, wood right	93 5/16"	76 15/16"	2

DCB6	Door Crossbar 6	--	--	1
------	--------------------	----	----	---

CDW1	Classic double window 1	60 1/4"	39"	1
------	-------------------------------	---------	-----	---

WCB6	Windows Crossbar 6	--	--	2
------	-----------------------	----	----	---



Hitblock	11 13/16"-15 3/4"		
Door bolt	12 3/8" x 2 9/16"		2
Screws	3/16" x 2 3/4"		15
Bolts	M5/16" x 2 3/4"		15
Screws	3/16" x 1 9/16"		16
Screws	1/4" x 5 1/2"		63
Screws	3/16" x 1 9/16"		110
Screws	3/16" x 2"		670

Type	Count	Length
------	-------	--------

Windboard 18x40	5	86 5/8"
--------------------	---	---------

Type	Count
------	-------



Romb	2
------	---







Garage D 1 9/16" (226 3/8"x20 1/16")

List of all items 1



Impregnated foundation beams

Mark	Type	Profile	Count	Length
IFB1	IFB 70x40		2	226"
IFB2	IFB 70x40		2	194 7/8"
IFB3	IFB 70x40		1	6 5/16"

Fascia Schedule

Mark	Type	Profile	Count	Length
EE	Eave Edging 18x95		4	130"
RF	Roof Fascia 18x120		4	130"
RR1	Roof reinforc ement 18x95		2	222 7/16"
RR2	Roof reinforc ement 38x38		2	222 7/16"

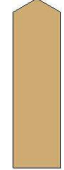
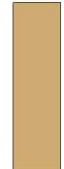
Roof

Mark	Type	Profile	Count	Length
RFR	Ridge 45x195		1	222 7/16"
RFB	Beam 45x195		8	222 7/16"
RB	17x114		102	128 5/16"

Garage D 1 9/16" (226 3/8"x20 1/16")

List of all items 2

Wall 1			
Mark	Profile	Count	Cut Length

1BL-1	4OX57	2	14"
1BL-2	4OX57	1	18 1/2"
1LG-1	4OX114	34	14"
1LG-2	4OX114	17	18 1/2"
1LG-3 *	4OX114	1	29 7/8"
1LG-4 *	4OX114	1	59 5/8"
1LG-5 *	4OX114	1	88 3/16"
1LG-6 *	4OX114	1	119 1/8"
1LG-7 *	4OX114	1	148 7/8"
1LG-8 *	4OX114	1	177 11/16"
1LG-9 *	4OX114	1	208 3/8"
1LG-10	4OX114	1	234 1/4"
1LG-11 *	4OX114	1	234 1/4"

Wall A			
Mark	Profile	Count	Cut Length

ALG-1	4OX114	17	22 5/8"
ALG-2	4OX114	9	43 3/16"
ALG-3	4OX114	9	48 3/4"
ALG-4	4OX114	8	152 9/16"
ALG-5	4OX114	1	208 11/16"
ATL-1	4OX114	1	222 7/16"

Wall 2			
Mark	Profile	Count	Cut Length

2BL-1	4OX57	1	234 1/4"
2LG-1 *	4OX114	1	29 7/8"
2LG-2 *	4OX114	1	59 5/8"
2LG-3 *	4OX114	1	88 3/16"
2LG-4 *	4OX114	1	119 1/8"
2LG-5 *	4OX114	1	148 7/8"
2LG-6 *	4OX114	1	177 11/16"
2LG-7 *	4OX114	1	208 3/8"
2LG-8	4OX114	18	234 1/4"
2LG-9 *	4OX114	1	234 1/4"

* Gable - delivered premounted

Wall B			
Mark	Profile	Count	Cut Length

BLG-1	4OX114	19	13 3/4"
BLG-2	4OX114	1	13 3/4"

Wall C			
Mark	Profile	Count	Cut Length

CLG-1	4OX114	18	208 11/16"
CTL-1	4OX114	1	222 7/16"

Log profiles	
Profile	Profile

4OX57	
-------	---

Log profiles	
Profile	Profile

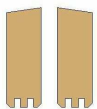
4OX114	
--------	---

Log profiles	
Profile	Profile

4OX114	
--------	--

Log profiles	
Profile	Profile

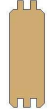
4OX114	
--------	---