

Diana 40 (141 3/4" x 216 1/2")

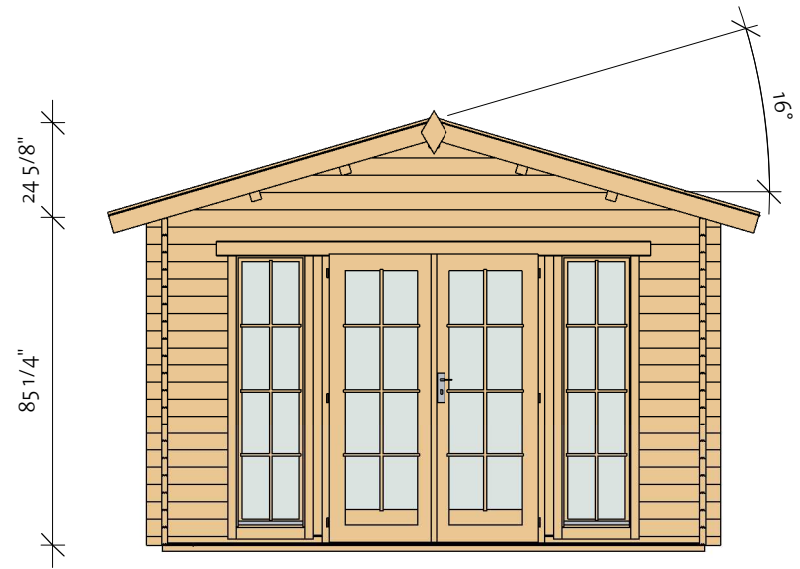
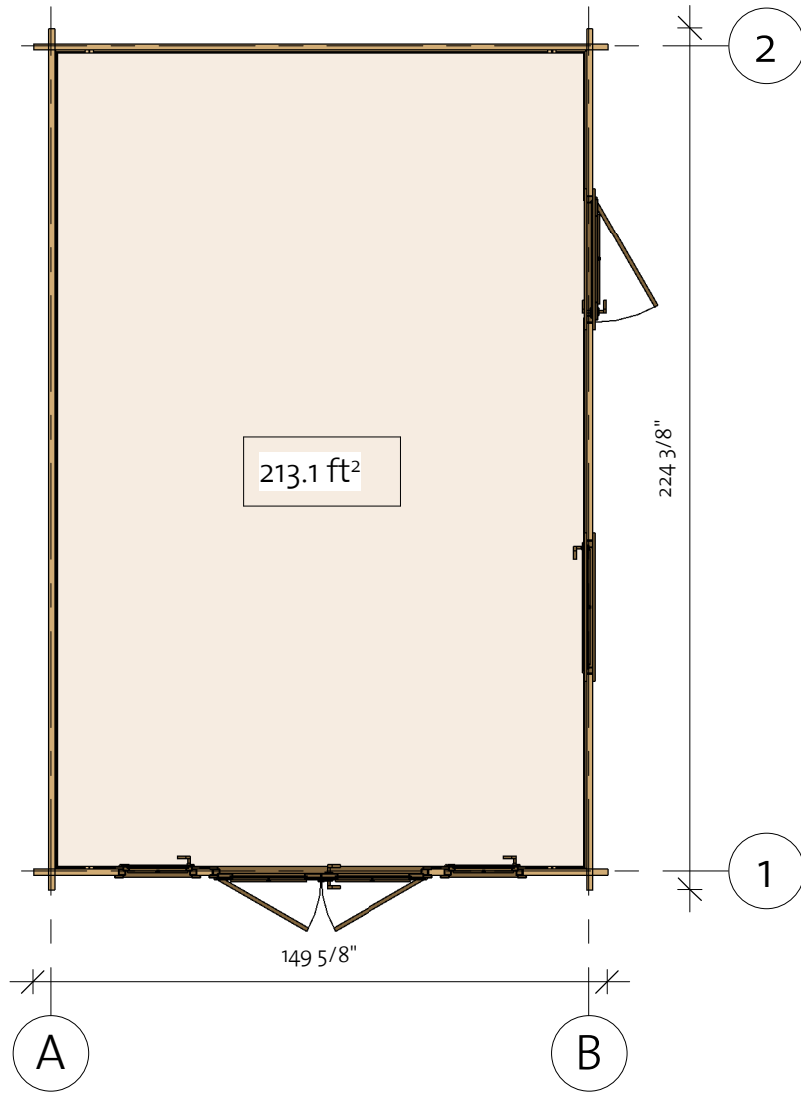

EZ Log Structures
Do-It-Yourself Building Kits

Diana 40 (141 3/4" x 216 1/8")

Foundation

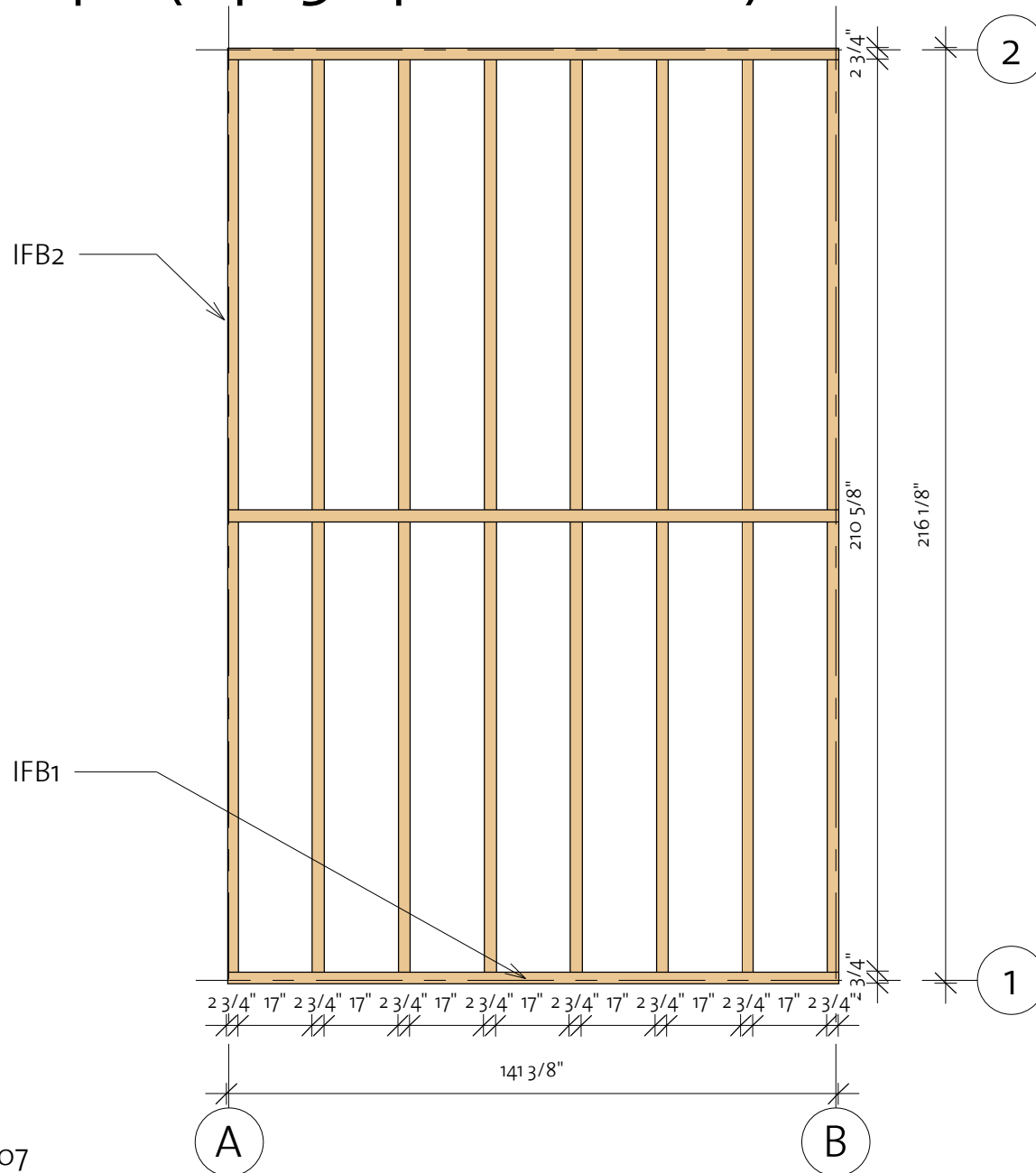



Impregnated foundation beams				
Mark	Type	Profile	Count	Length
IFB1	IFB 70x40		3	141 3/8"
IFB2	IFB 70x40		16	103 7/8"

Diana 40 (141 3/4" x 216 1/2")

Floor Plan

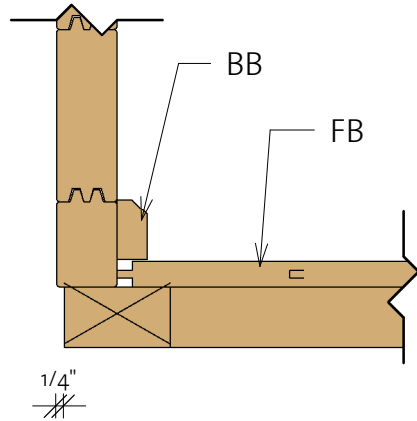
① Baseboard



Floor Schedule				
Mark	Type	Profile	Count	Length
FB	FB 17x114		49	138 1/2"
BB1	BB 20x40		2	141 3/4"
BB2	BB 20x40		2	216 1/2"

91811052_210907

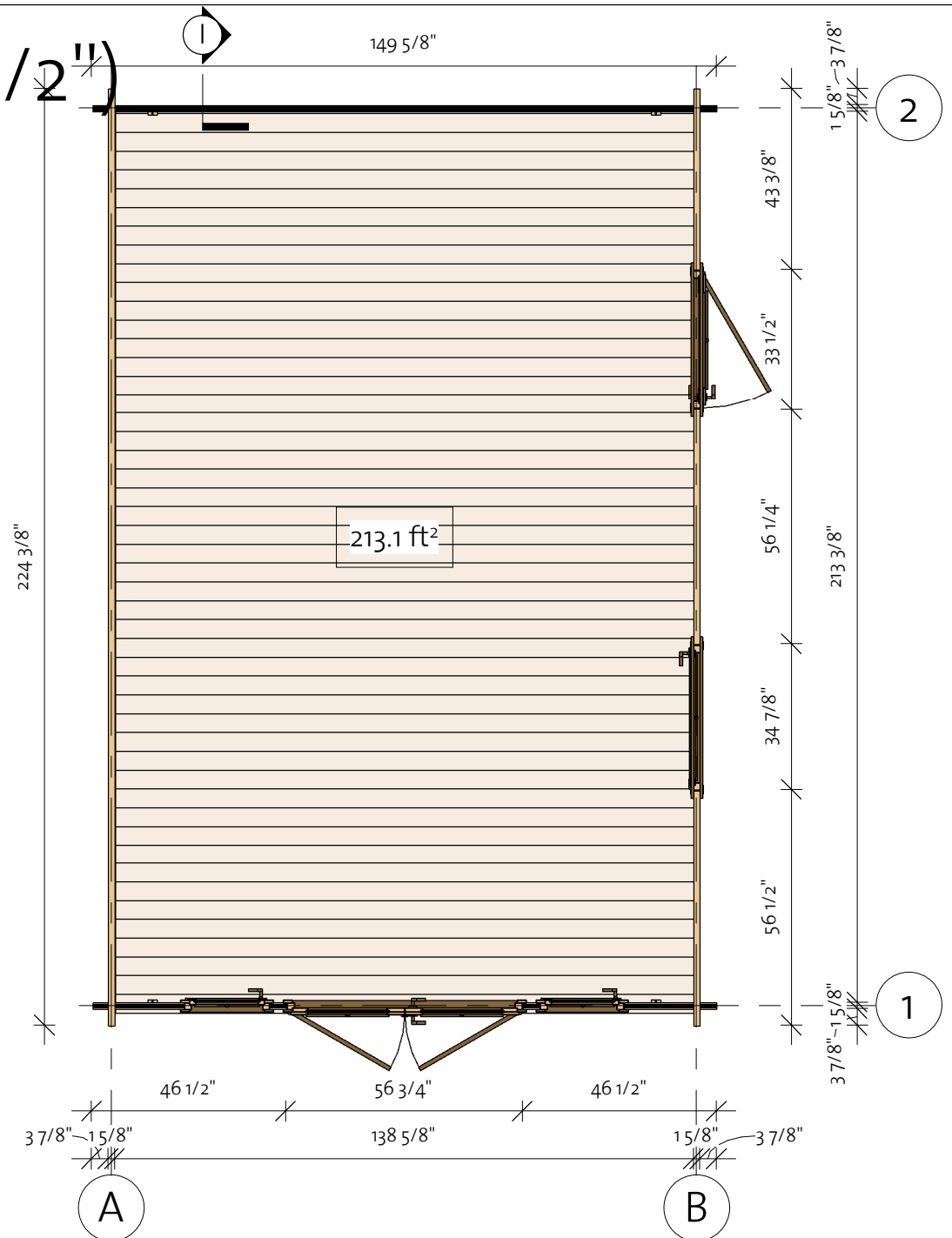

Diana 40 (141 3/4" x 216 1/2")

Wall 1

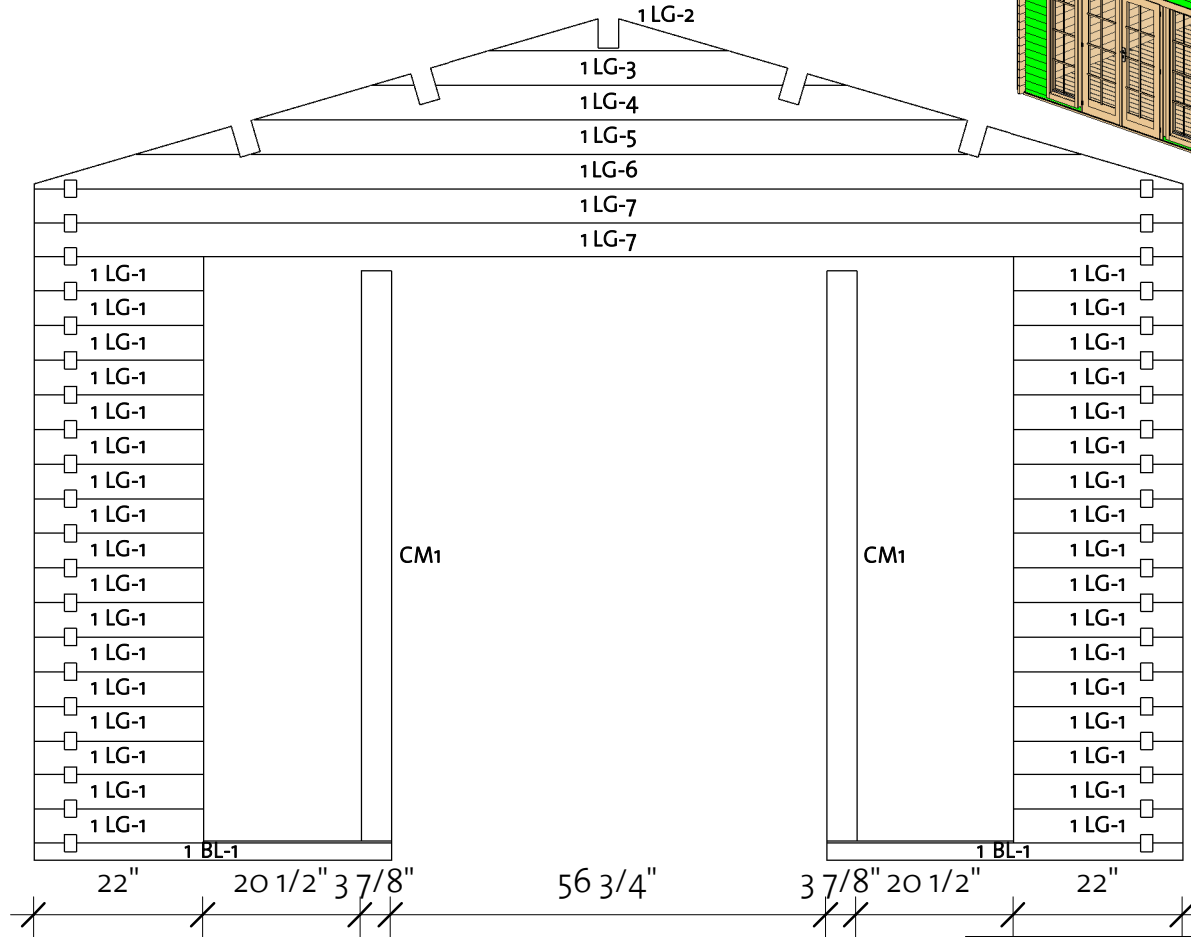
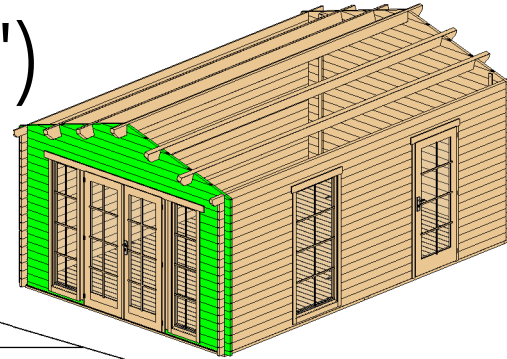



Wall 1			
Mark	Profile	Count	Cut Length

1BL-1	40X57	2	46 1/2"
1LG-1	40X114	34	22"
1LG-2*	40X114	1	31 1/8"
1LG-3*	40X114	1	61 7/8"
1LG-4*	40X114	1	92 1/2"
1LG-5*	40X114	1	123 1/4"
1LG-6*	40X114	1	149 5/8"
1LG-7	40X114	2	149 5/8"

* Gable - delivered premounted

Log Profile Wall 1	
Profile	Profile

40X57	
40X114	

Columns			
Mark	Profile	Count	Length
CM1	Post 100X40	2	74 1/8"

Diana 40 (141 3/4" x 216 1/2")

Wall 2

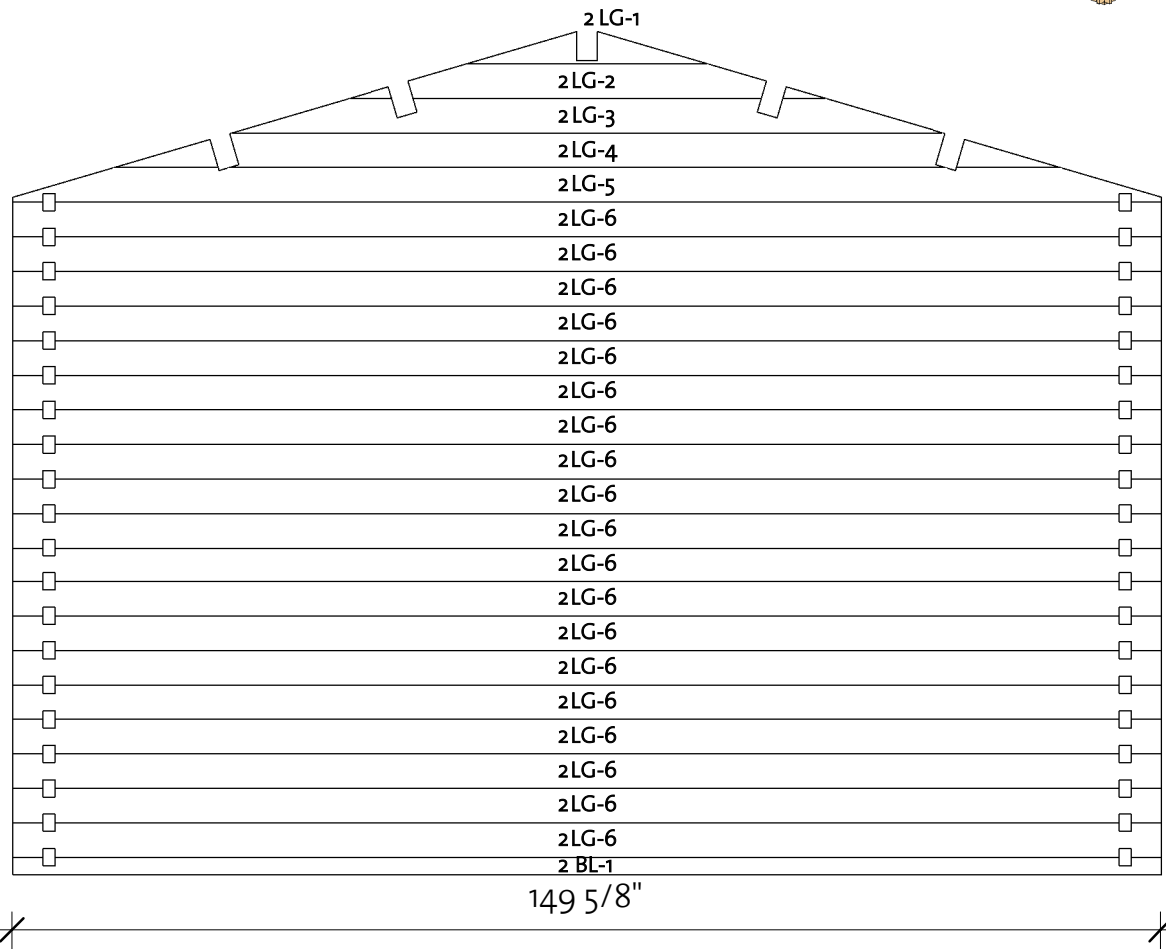
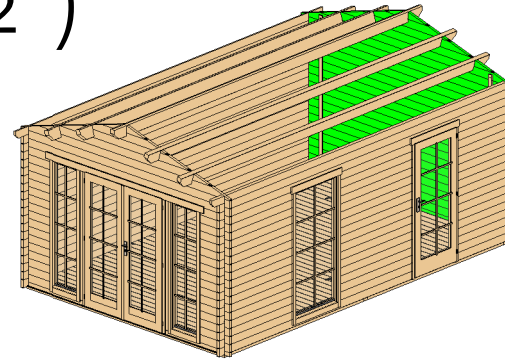

Wall 2			
Mark	Profile	Count	Cut Length

2BL-1	40X57	1	149 5/8"
2LG-1*	40X114	1	31 1/8"
2LG-2*	40X114	1	61 7/8"
2LG-3*	40X114	1	92 1/2"
2LG-4*	40X114	1	123 1/4"
2LG-5*	40X114	1	149 5/8"
2LG-6	40X114	19	149 5/8"

* Gable - delivered premounted

Log Profile Wall 2	
Profile	Profile



40X57	
40X114	

Diana 40 (141 3/4" x 216 1/2")

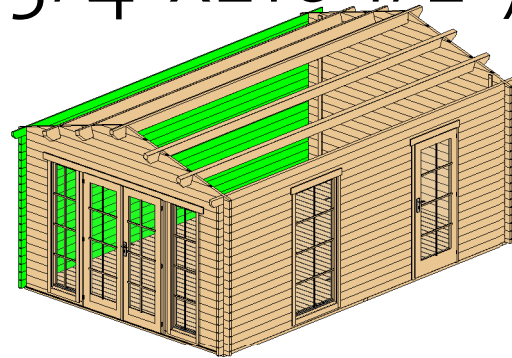
Wall A

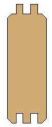

Log Profile Wall A	
Profile	Profile

4OX114	
4OX114	

Wall A			
Mark	Profile	Count	Cut Length

ALG-1	4OX114	19	224 3/8"
ATL-1	4OX114	1	235 3/8"

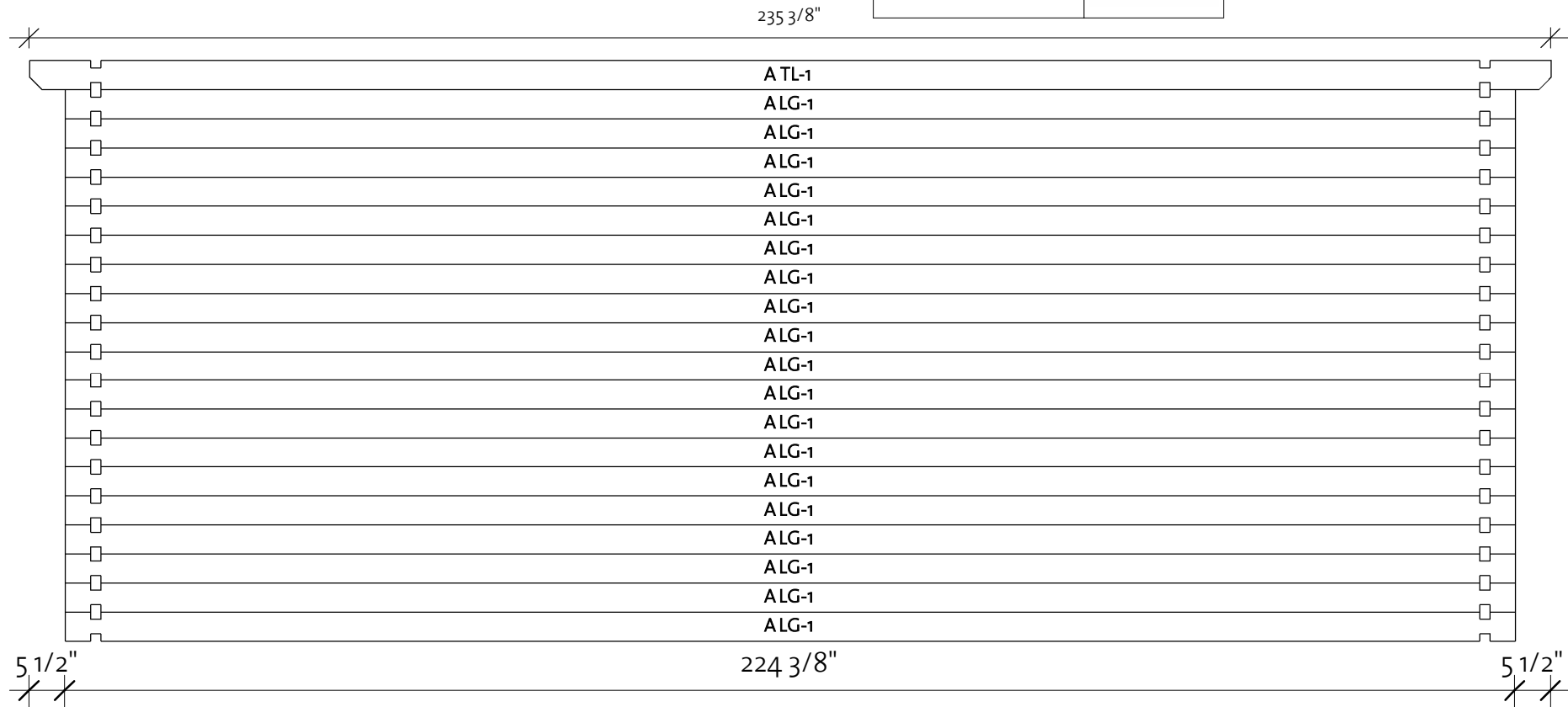

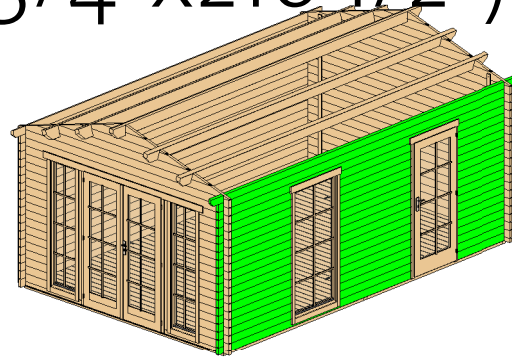

Diana 40 (141 3/4" x 216 1/2")

Wall B



Log Profile Wall B	
Profile	Profile

40X114	
40X114	

Wall B			
Mark	Profile	Count	Cut Length

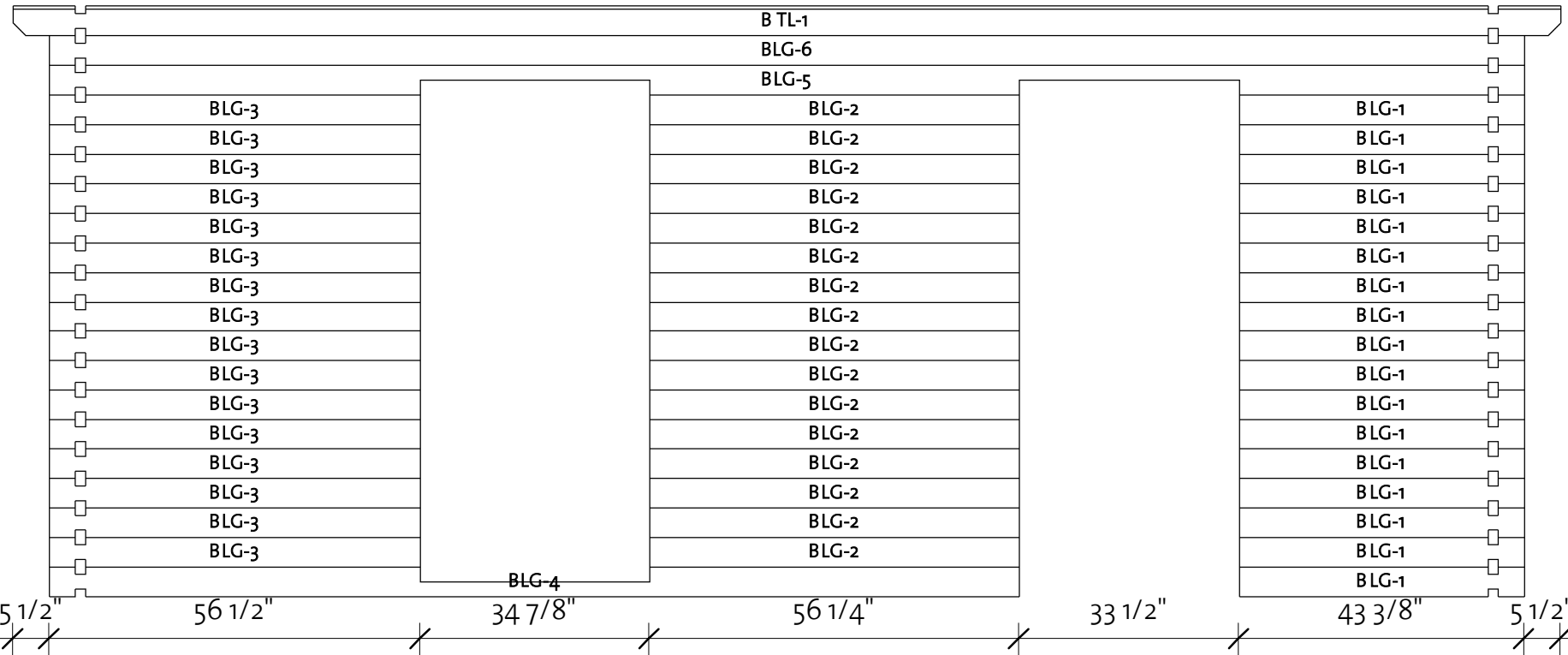

BLG-1	40X114	17	43 3/8"
BLG-2	40X114	16	56 1/4"
BLG-3	40X114	16	56 1/2"
BLG-4	40X114	1	147 1/2"
BLG-5	40X114	1	224 3/8"
BLG-6	40X114	1	224 3/8"
BTL-1	40X114	1	235 3/8"

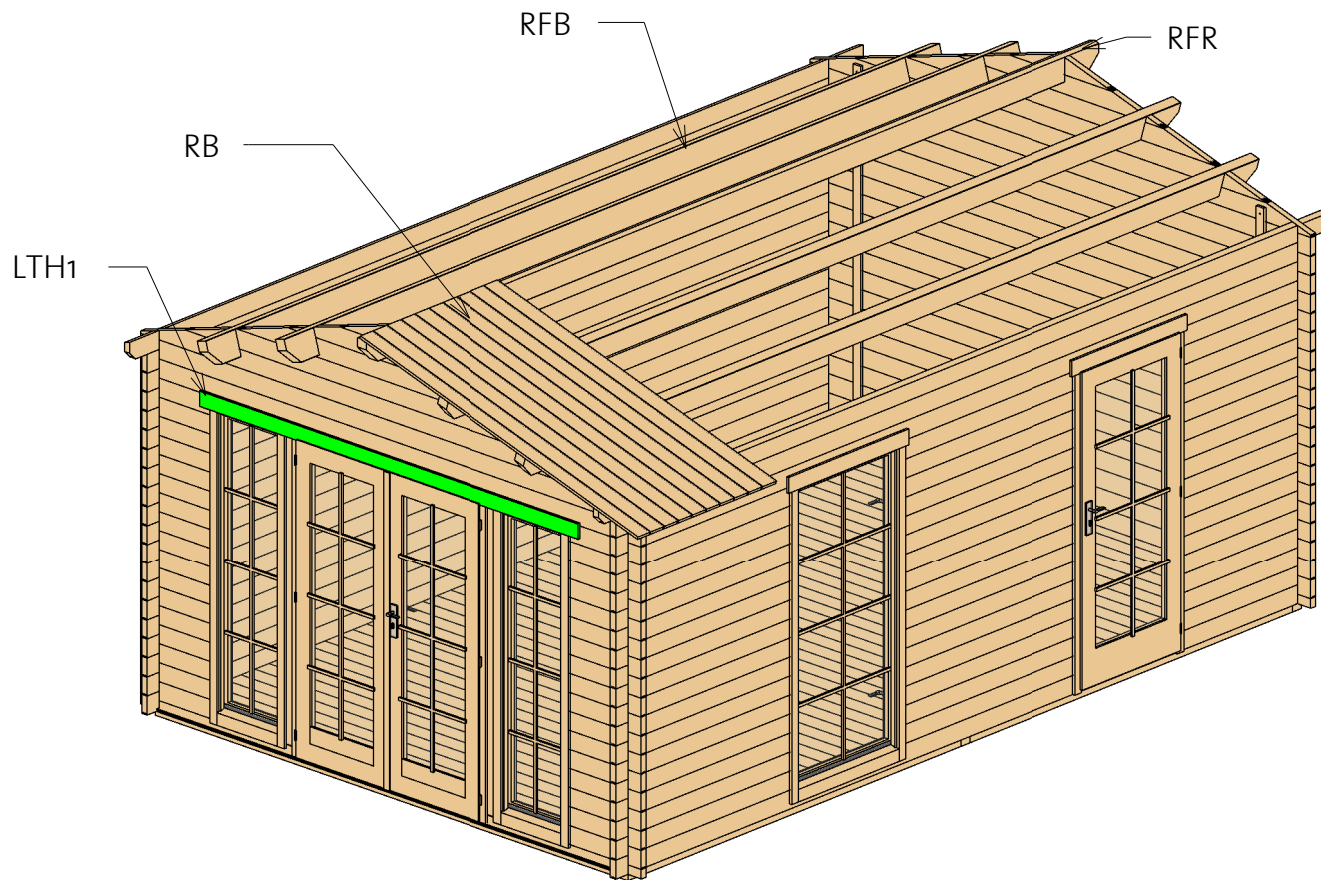

Diana 40 (141 3/4" x 216 1/2")

Roof 1



Roof				
Mark	Type	Profile	Count	Length
RFR	Ridge 68x160		1	235 3/8"
RFB	Beam 68x160		4	235 3/8"
RB	17x114		108	86 5/8"

Lath list				
Mark	Type	Profile	Count	Length
LTH1	18x95		2	113 1/4"

Diana 40 (141 3/4" x 216 1/2")

Roof 2

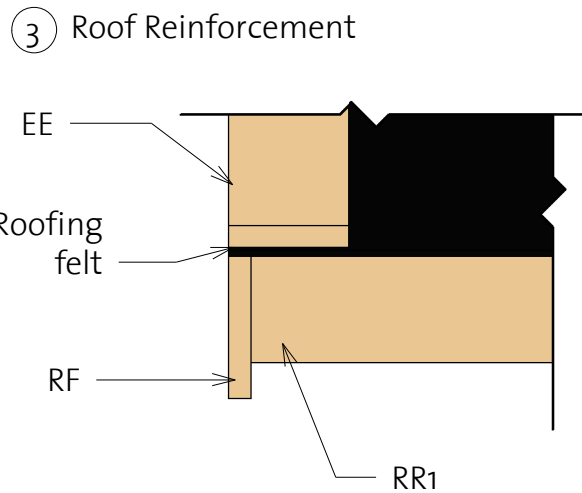
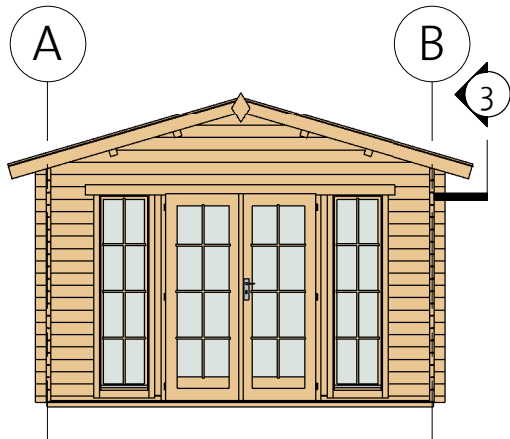
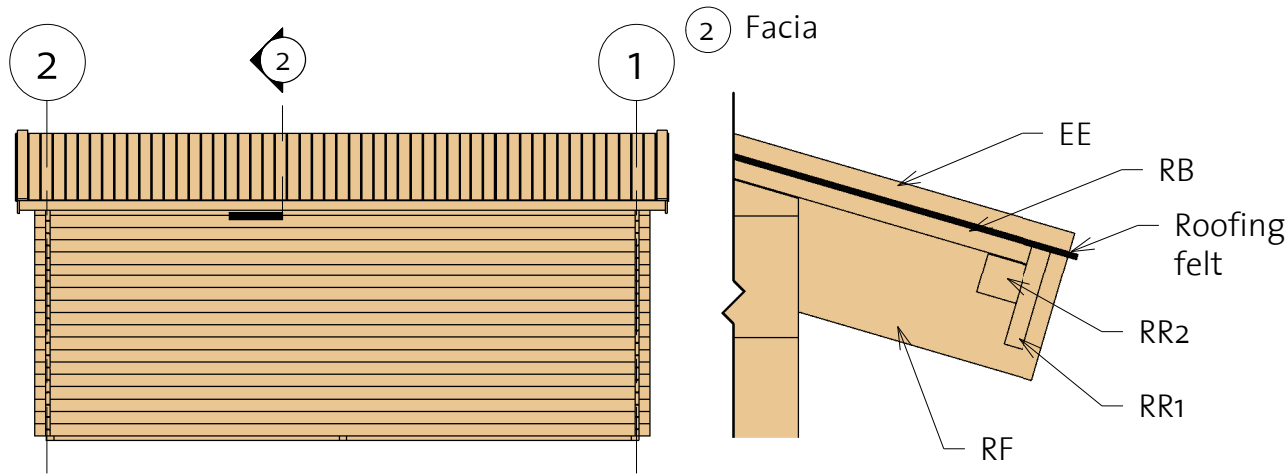

Fascia Schedule				
Mark	Type	Profile	Count	Length
EE	Eave Edging 18x95		4	88 1/4"
RF	Roof Fascia 18x120		4	88 1/4"
RR1	Roof reinforcement 18x95		2	235 3/8"
RR2	Roof reinforcement 38x38		2	235 3/8"

Diana 40 (141 3/4" x 216 1/2")

Extras

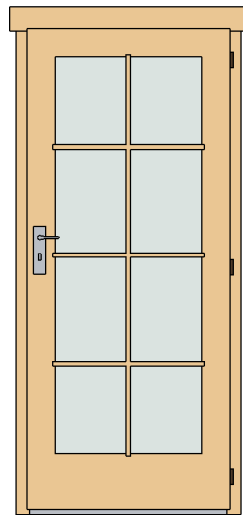
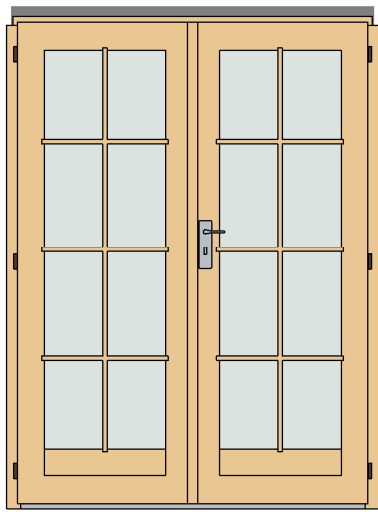

Door Schedule				
Mark	Type	Width	Height	Count
CD6R	Classic door 6 right	33 1/8"	77"	1
CDD3R	Classic double door 3 right	56 1/8"	77"	1
DCB8	Door Crossbar 8	--	--	1/8"

Type	Count	Length
Windboard 18x40	4	87 3/8"

Family	Count
Romb	2

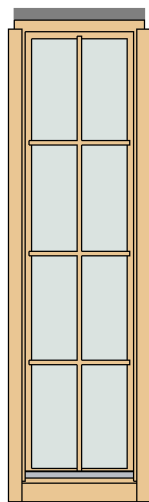
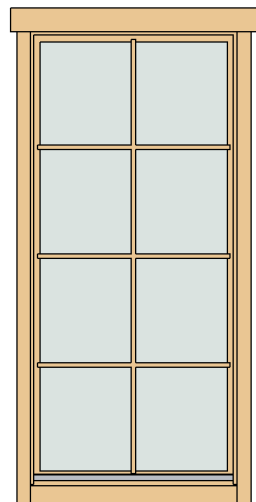

Window Schedule				
Mark	Type	Width	Height	Count
CW4R	Classic window 4, right	34 1/2"	74 3/8"	1
CW21R	Classic window 21 right	20 1/4"	74 3/8"	2
WCB8-1	Windows Crossbar 8-1	--	--	1
WCB8-2	Windows Crossbar 8-2	--	--	2

Fasteners & Extras		
Name	Type	Count
Hitblock	300-400 mm	
Screws	5,0 x 70	10
Bolts	M8 x 70	12
Nails	1,4 x 40	45
Screws	6,0 x 140	60
Screws	4,0 x 40	1030



- * Windows intended for tilt opening only!
- * Fenster zur Eröffnung nur zum Kippen vorgesehen!
- * Aknad on ette nähtud ainult kaldu avamiseks!

91811052_210907



Diana 40 (141 3/4"x216 1/2")

List of all items 1



Impregnated foundation beams

Mark	Type	Profile	Count	Length
IFB1	IFB 70x40		3	141 3/8"
IFB2	IFB 70x40		16	103 7/8"





Floor Schedule

Mark	Type	Profile	Count	Length
FB	FB 17x114		49	138 1/2"
BB1	BB 20x40		2	141 3/4"
BB2	BB 20x40		2	216 1/2"

Roof

Mark	Type	Profile	Count	Length
RFR	Ridge 68x160		1	235 3/8"
RFB	Beam 68x160		4	235 3/8"
RB	17x114		108	86 5/8"

Fascia Schedule

Mark	Type	Profile	Count	Length
EE	Eave Edging 18x95		4	88 1/4"
RF	Roof Fascia 18x120		4	88 1/4"
RR1	Roof reinforcement 18x95		2	235 3/8"
RR2	Roof reinforcement 38x38		2	235 3/8"

Diana 40 (141 3/4" x 216 1/2")

List of all items 2

Wall 1			
Mark	Profile	Count	Cut Length

1BL-1	40X57	2	46 1/2"
1LG-1	40X114	34	22"
1LG-2*	40X114	1	31 1/8"
1LG-3*	40X114	1	61 7/8"
1LG-4*	40X114	1	92 1/2"
1LG-5*	40X114	1	123 1/4"
1LG-6*	40X114	1	149 5/8"
1LG-7	40X114	2	149 5/8"



Wall A			
Mark	Profile	Count	Cut Length

ALG-1	40X114	19	224 3/8"
ATL-1	40X114	1	235 3/8"

Lath list				
Mark	Type	Profile	Count	Length

LTH1	18x95		2	113 1/4"
------	-------	---	---	----------

Log Profiles	
Profile	Profile

40X57	
40X114	

Wall 2			
Mark	Profile	Count	Cut Length

2BL-1	40X57	1	149 5/8"
2LG-1*	40X114	1	31 1/8"
2LG-2*	40X114	1	61 7/8"
2LG-3*	40X114	1	92 1/2"
2LG-4*	40X114	1	123 1/4"
2LG-5*	40X114	1	149 5/8"
2LG-6	40X114	19	149 5/8"

* Gable - delivered premounted

Wall B			
Mark	Profile	Count	Cut Length

BLG-1	40X114	17	43 3/8"
BLG-2	40X114	16	56 1/4"
BLG-3	40X114	16	56 1/2"
BLG-4	40X114	1	147 1/2"
BLG-5	40X114	1	224 3/8"
BLG-6	40X114	1	224 3/8"
BTL-1	40X114	1	235 3/8"

Columns			
Mark	Profile	Count	Length

CM1	Post 100X40	2	74 1/8"
-----	----------------	---	---------

Log Profiles	
Profile	Profile

40X114	
--------	---