

Atlanta 2 40 (280x556)

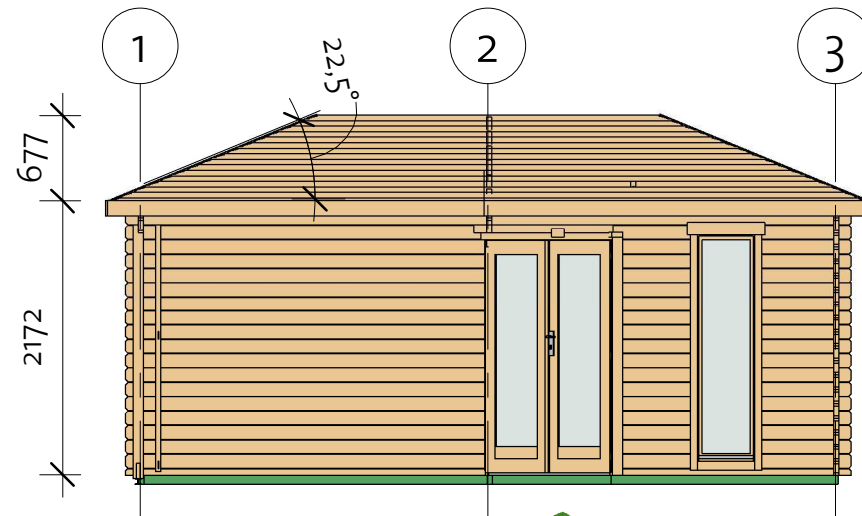
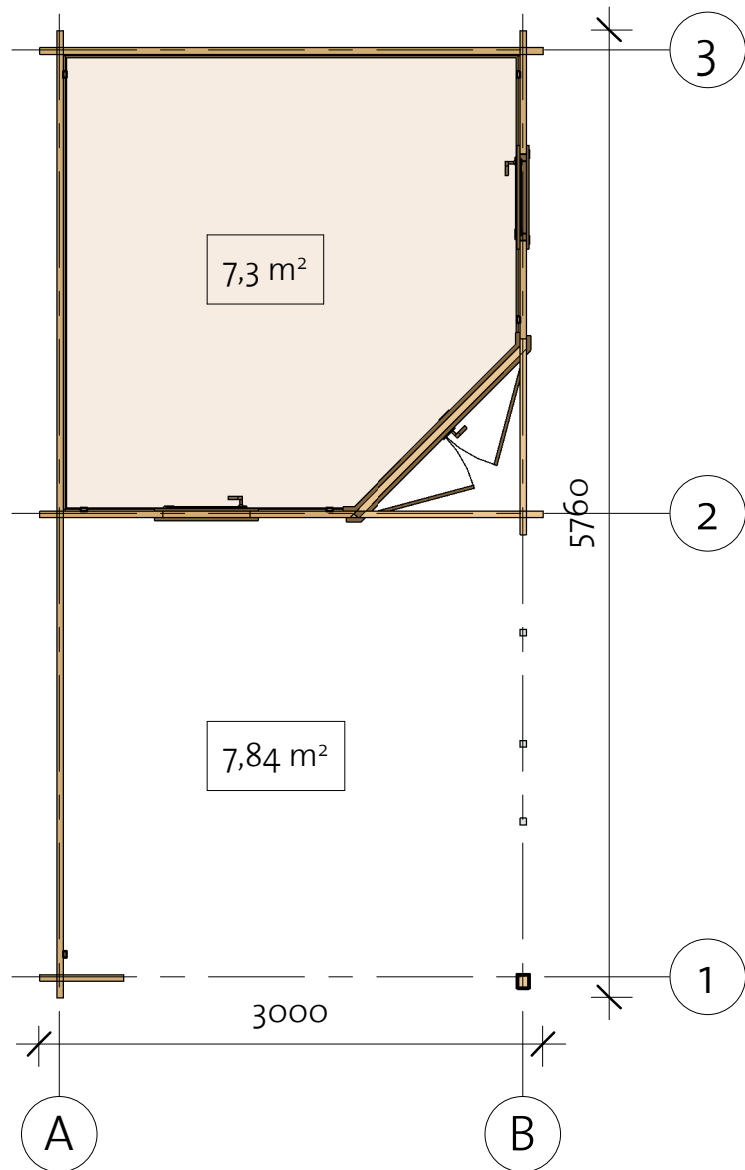

4200016_210921

EZ Log Structures
Do-It-Yourself Building Kits

Atlanta 2 40 (280x556)

Foundation

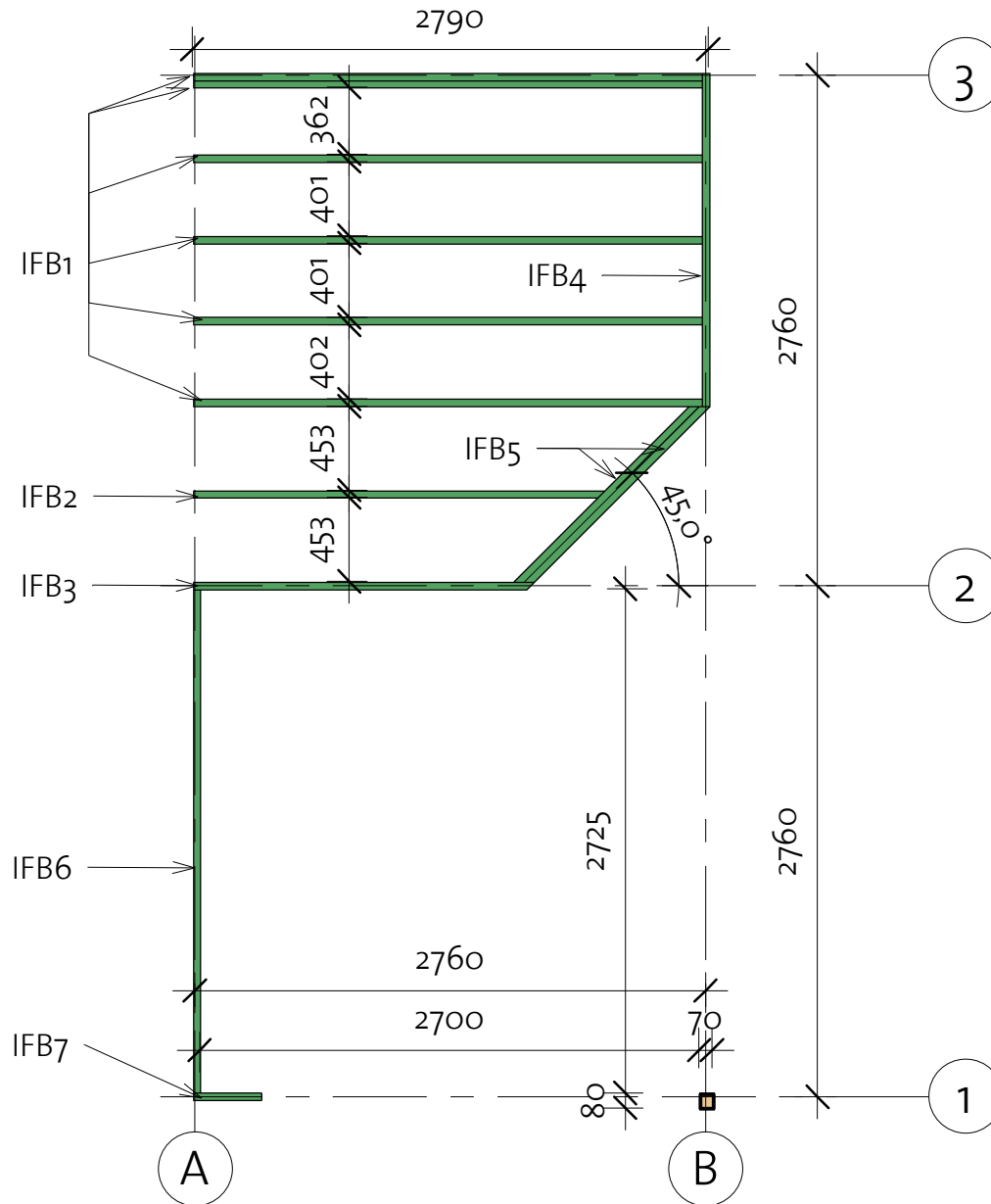

Impregnated foundation beams

Mark	Type	Profile	Count	Length
IFB1	IFB 40x70		6	2750
IFB2	IFB 40x70		1	2224
IFB3	IFB 40x70		1	1845
IFB4	IFB 40x70		1	1805
IFB5	IFB 40x70		2	1376
IFB6	IFB 40x70		1	2720
IFB7	IFB 40x70		1	375

Atlanta 2 40 (280x556)

Floor Plan (I) Baseboard

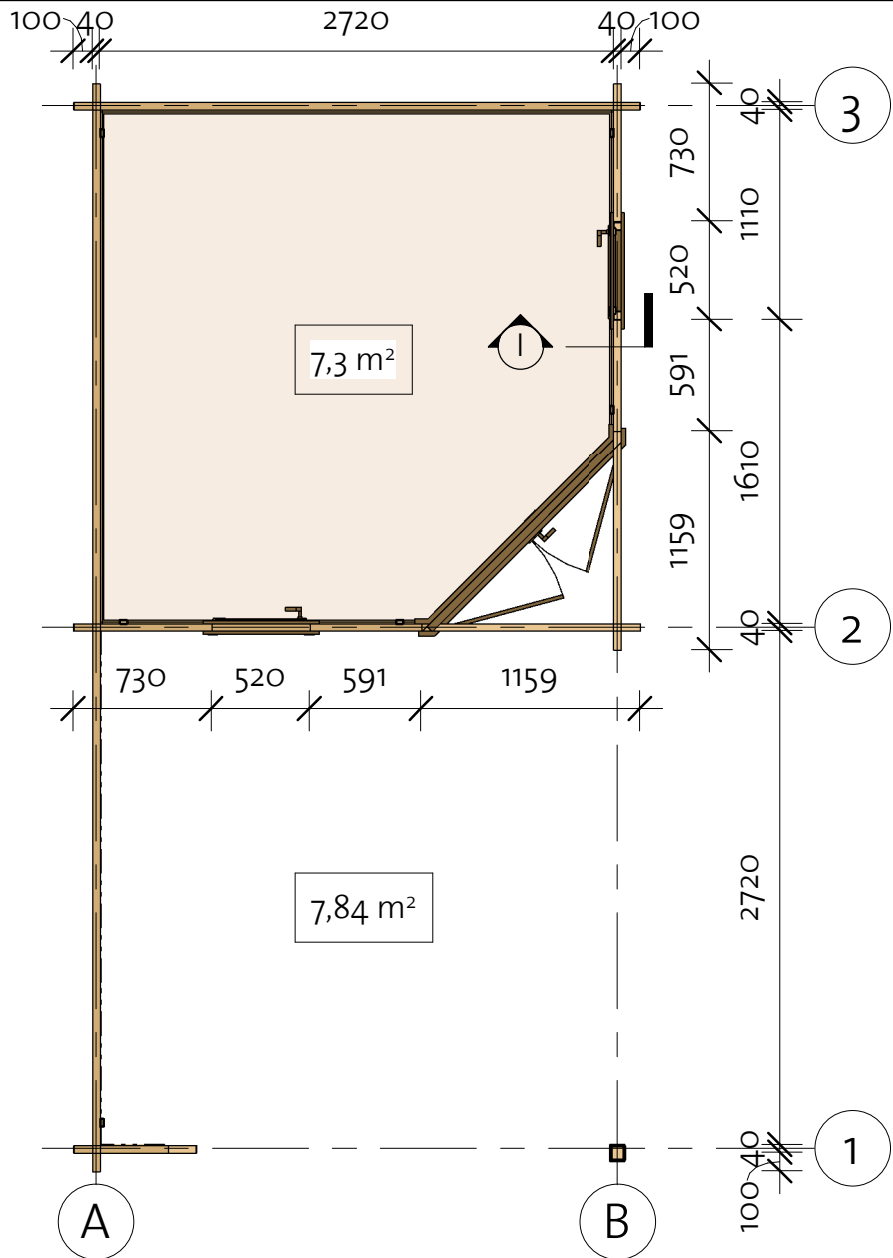
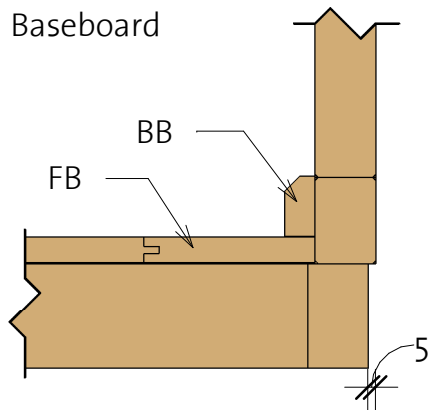

Floor Schedule

Mark	Type	Profile	Count	Length
------	------	---------	-------	--------

FB 1	FB 17x114		1	1837
FB 2	FB 17x114		1	1951
FB 3	FB 17x114		1	2065
FB 4	FB 17x114		1	2179
FB 5	FB 17x114		1	2293
FB 6	FB 17x114		1	2407
FB 7	FB 17x114		1	2521
FB 8	FB 17x114		1	2635
FB 9	FB 17x114		16	2717
FB 10	FB 17x114		1	2717

BB	BB 20x40		4	2800
----	----------	---	---	------

Atlanta 2 40 (280x556)

Wall 1

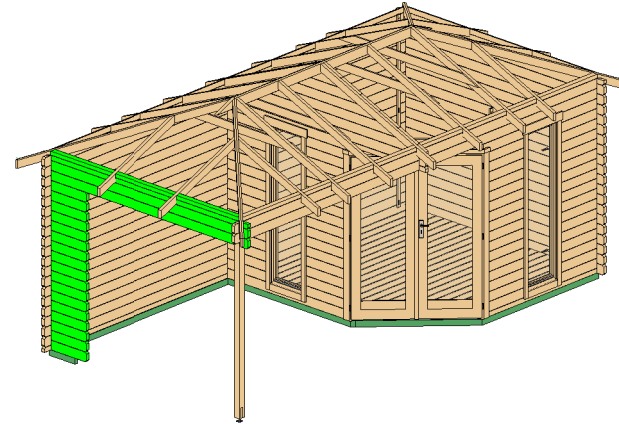

Wall 1			
Mark	Profile	Count	Cut Length
1LG 1	40x114	17	650
1LG 2	40x114	1	3000
1LG 3	40x114	1	3000
1TL 1	40x63	1	902
1TL 2	40x63	1	860
1TL 3	40x63	1	902
1TL 4	40x57 TL	1	3000

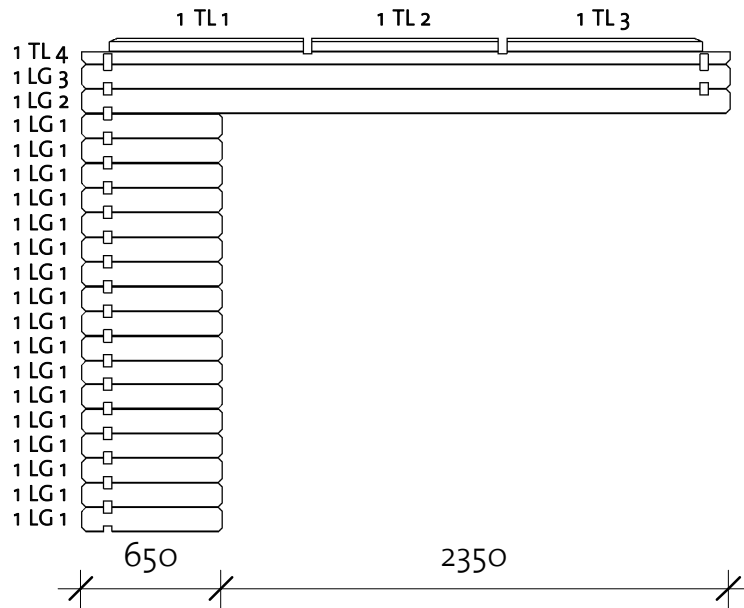

Log Profile Wall 1	
Profile	Profile

40x57 TL	
40x63	
40x114	

Atlanta 2 40 (280x556)

Wall 2

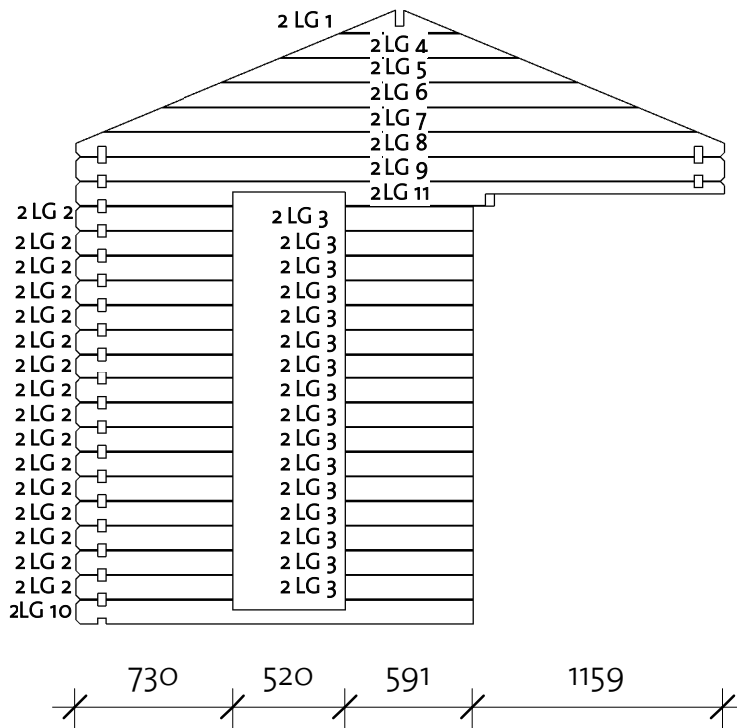
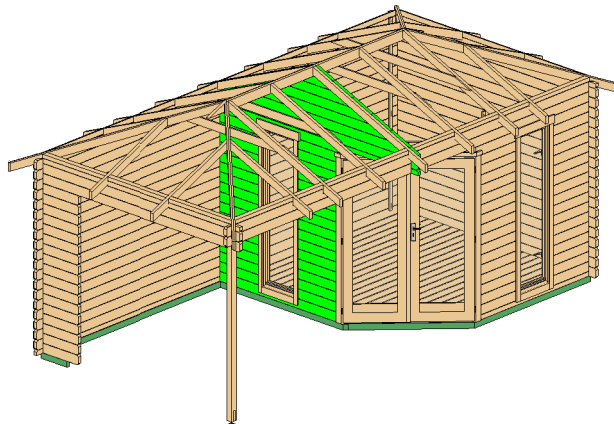

Wall 2			
Mark	Profile	Count	Cut Length

2LG 1 *	40X114	1	547
2LG 2	40X114	16	730
2LG 3	40X114	16	591
2LG 4 *	40X114	1	1098
2LG 5 *	40X114	1	1648
2LG 6 *	40X114	1	2199
2LG 7 *	40X114	1	2749
2LG 8 *	40X114	1	3000
2LG 9	40X114	1	3000
2LG 10	40X114	1	1841
2LG 11	40X114	1	3000
2LG 11/M	40X114	1	3000

* Gable - delivered premounted

Log Profile Wall 2	
Profile	Profile

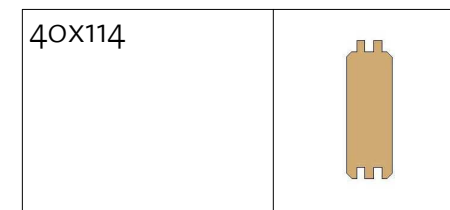

Atlanta 2 40 (280x556)

Wall 3

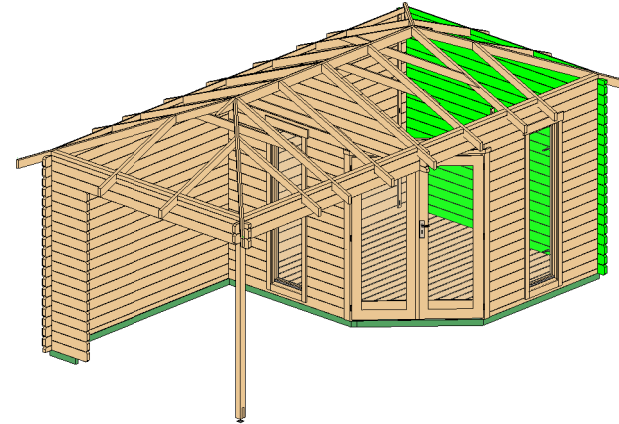

Wall 3			
Mark	Profile	Count	Cut Length

3LG 1	40x114	19	3000
3TL 1	40x63	1	902
3TL 2	40x63	1	860
3TL 3	40x63	1	902
3TL 4	40x57 TL	1	3000

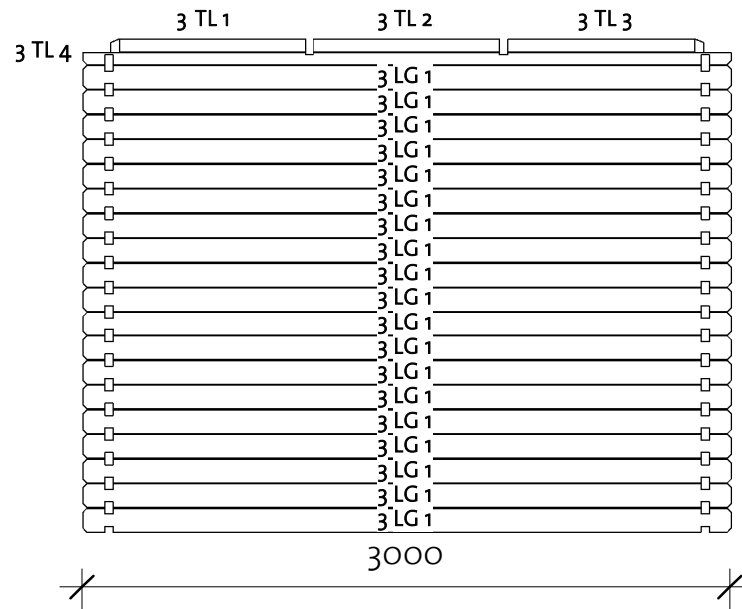

Log Profile Wall 3	
Profile	Profile

40x57 TL	
40x63	
40x114	

Atlanta 2 40 (280x556)

Wall A

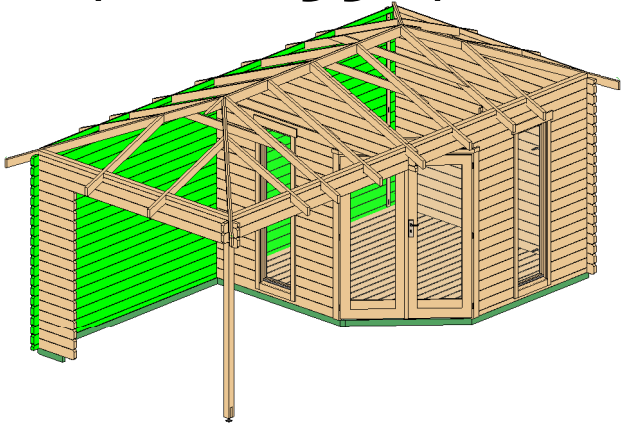

Wall A			
Mark	Profile	Count	Cut Length

ABL 1	40x57	1	5760
ALG 1	40x114	18	5760
ALG 2	40x114	1	5760
ATL 1	40x63	1	902
ATL 2	40x63	1	902
ATL 3	40x63	2	640
ATL 4	40x63	2	620
ATL 5	40x63	2	430

Log Profile Wall A	
Profile	Profile

40x63	
40x114	
40x57	

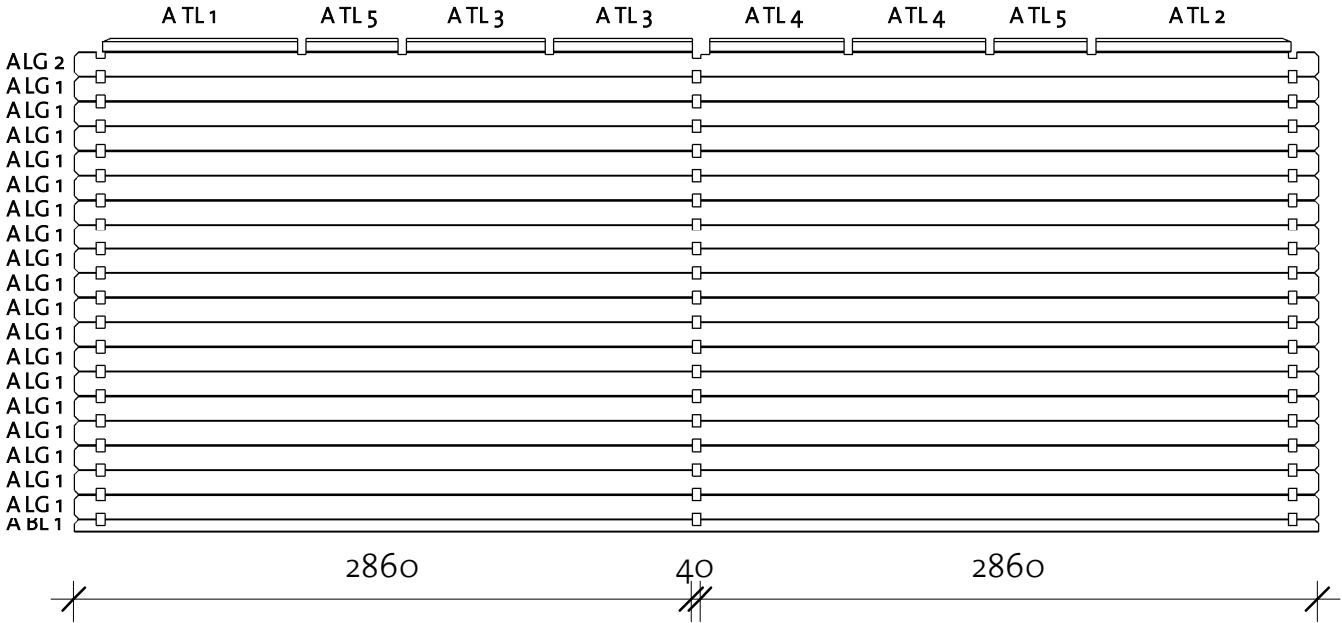

Atlanta 2 40 (280x556)

Wall B

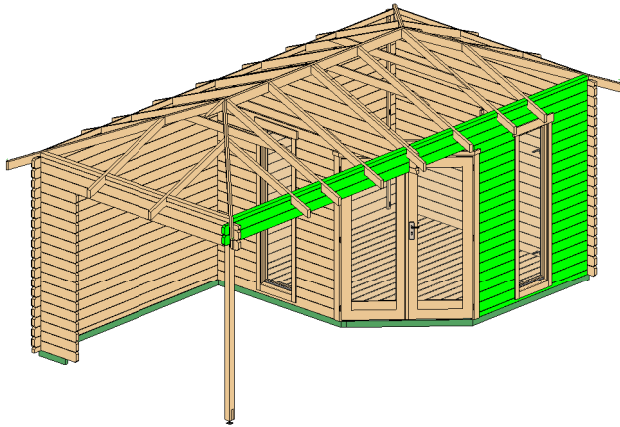

Wall B			
Mark	Profile	Count	Cut Length

BBL 1	40x57	1	1841
BLG 1	40x114	16	591
BLG 2	40x114	17	730
BLG 3	40x114	1	688

Wall B			
Mark	Profile	Count	Cut Length

BLG 3/M	40x114	1	688
BLG 4	40x114	1	5760
BLG 5	40x114	1	5760
BTL 1	40x63	1	902
BTL 2	40x63	1	902
BTL 3	40x63	2	640
BTL 4	40x63	2	620
BTL 5	40x63	2	430

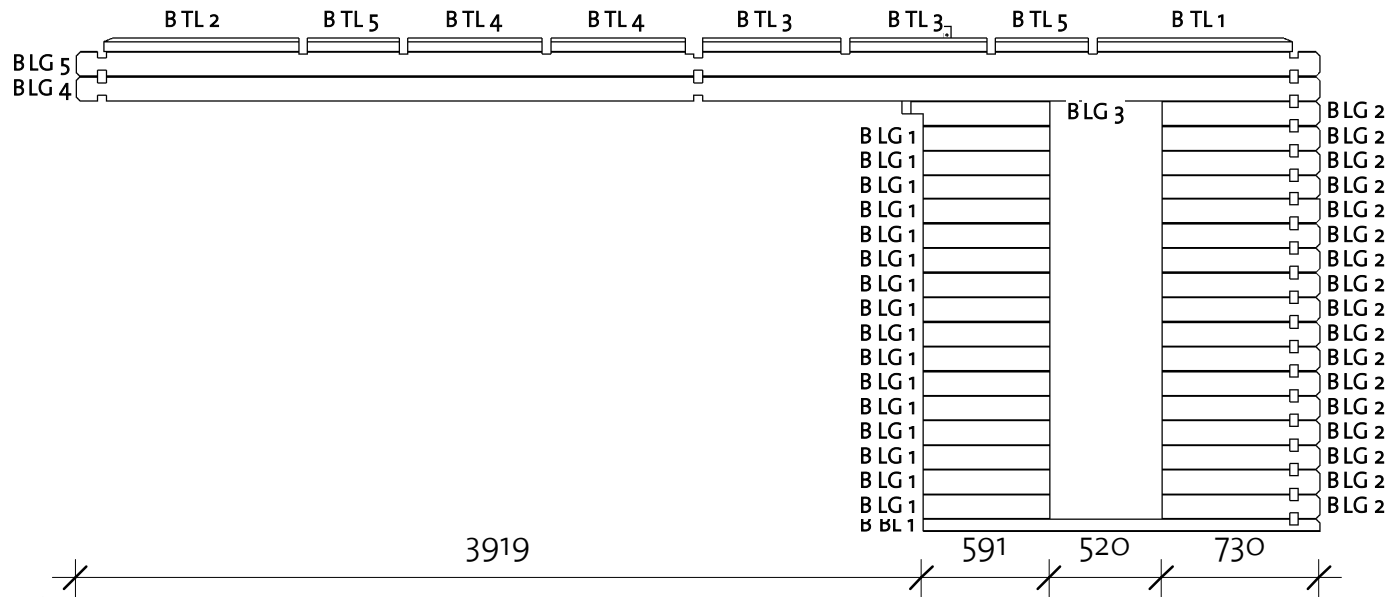

Log Profile Wall B	
Profile	Profile

40x63	
40x114	
40x57	

Atlanta 2 40 (280x556)

Roof 1

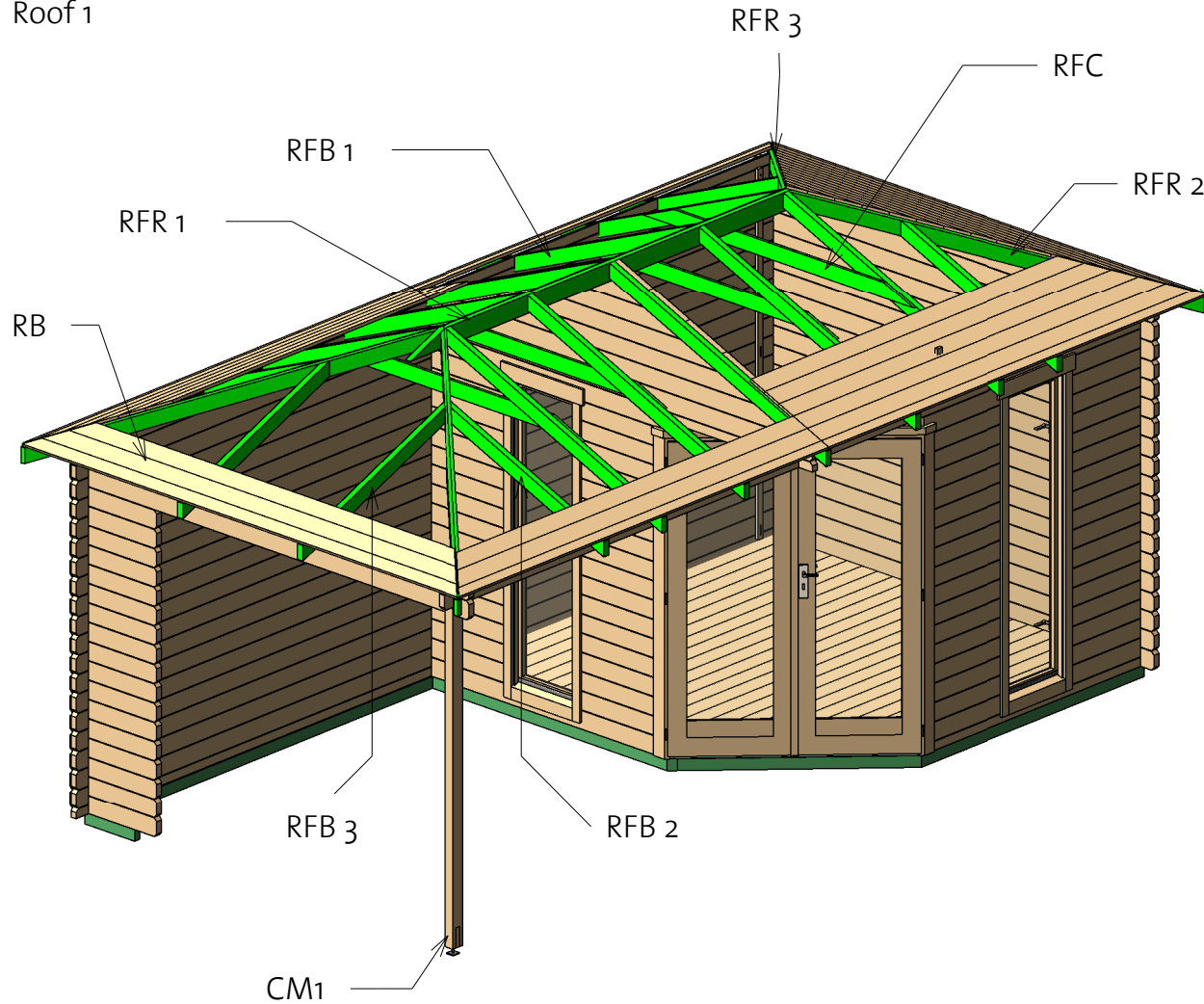

Roof				
Mark	Type	Profile	Count	Length
RFB1	40x85		10	1790
RFB2	40x85		4	1316
RFB3	40x85		4	1316
RFC	18x95		4	2025
RFR1	40x120		1	3340
RFR2	40x94		2	2431
RFR3	40x94		2	2431

Columns			
Mark	Type	Length	Count

CM1	Post 80x70	2021	1
-----	------------	------	---

Adjustable post foot	1	46
----------------------	---	----

Atlanta 2 40 (280x556)

Roof 2

Roofboards				
Mark	Type	Profile	Count	Length
RB 1	RoofBoard 17x114		2	165
RB 2	RoofBoard 17x114		2	376
RB 3	RoofBoard 17x114		2	586
RB 4	RoofBoard 17x114		2	797
RB 5	RoofBoard 17x114		2	1008
RB 6	RoofBoard 17x114		2	1218
RB 7	RoofBoard 17x114		2	1429
RB 8	RoofBoard 17x114		2	1640
RB 9	RoofBoard 17x114		2	1850
RB 10	RoofBoard 17x114		2	2061
RB 11	RoofBoard 17x114		2	2272
RB 12	RoofBoard 17x114		2	2482
RB 13	RoofBoard 17x114		2	2693
RB 14	RoofBoard 17x114		2	2904
RB 15	RoofBoard 17x114		2	3114
RB 16	RoofBoard 17x84		2	3269
RB 17	RoofBoard 17x114		2	2969

Roofboards				
Mark	Type	Profile	Count	Length
RB 18	RoofBoard 17x114		2	3180
RB 19	RoofBoard 17x114		2	3390
RB 20	RoofBoard 17x114		2	3601
RB 21	RoofBoard 17x114		2	3812
RB 22	RoofBoard 17x114		2	4022
RB 23	RoofBoard 17x114		2	4233
RB 24	RoofBoard 17x114		2	4444
RB 25	RoofBoard 17x114		2	4654
RB 26	RoofBoard 17x114		2	4865
RB 27	RoofBoard 17x114		2	2578
RB 28	RoofBoard 17x114		2	2683
RB 29	RoofBoard 17x114		2	2788
RB 30	RoofBoard 17x114		2	2814
RB 31	RoofBoard 17x114		2	2919
RB 32	RoofBoard 17x59		2	3052
RB 33	RoofBoard 17x59		2	2973
RB 34	RoofBoard 17x114		2	2894
RB 35	RoofBoard 17x114		2	2999
RB 36	RoofBoard 17x114		2	2708
RB 37	RoofBoard 17x114		2	2603
RB 38	RoofBoard 17x114		2	2498

Atlanta 2 40 (280x556)

Roof 3

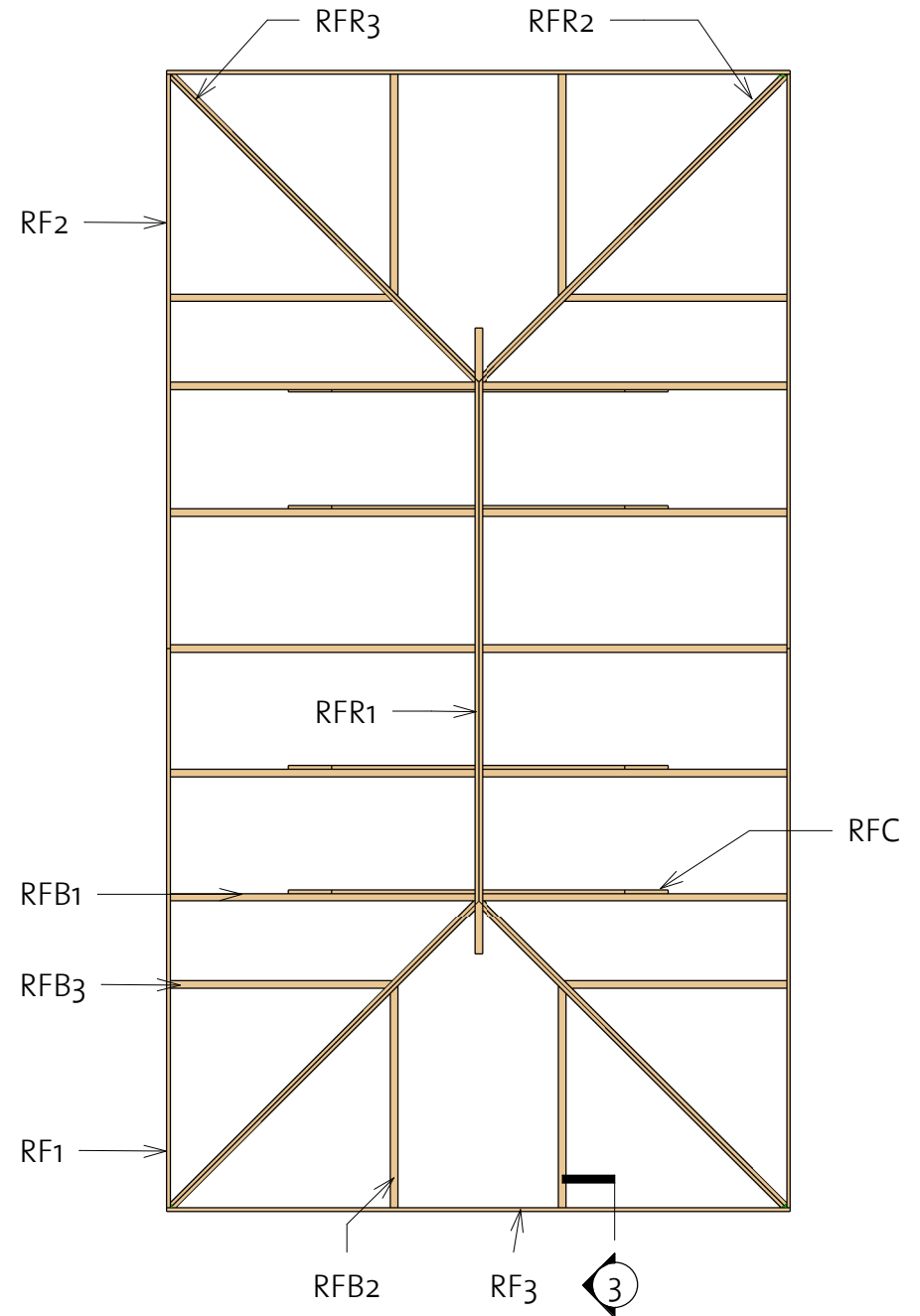
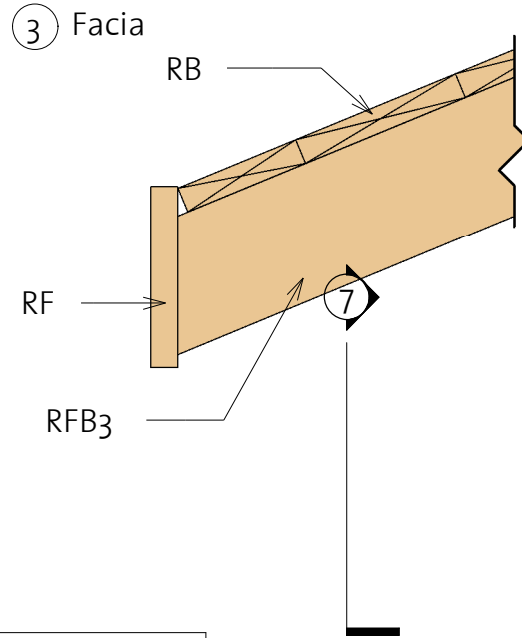
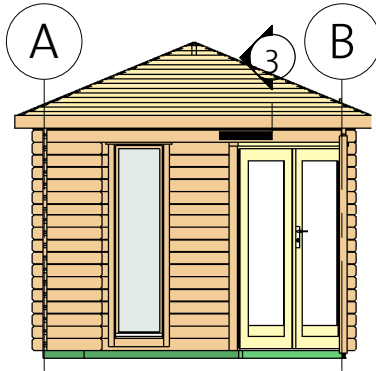

Fascia Schedule

Mark	Type	Profile	Count	Length
RF1	Roof Fascia 18x120		2	2982
RF2	Roof Fascia 18x120		2	3061
RF3	Roof Fascia 18x120		2	3319

4200016_210921

Atlanta 2 40 (280x556)

Extras

- * Windows intended for tilt opening only!
- * Fenster zur Eröffnung nur zum Kippen vorgesehen!
- * Aknad on ette nähtud ainult kaldu avamiseks!

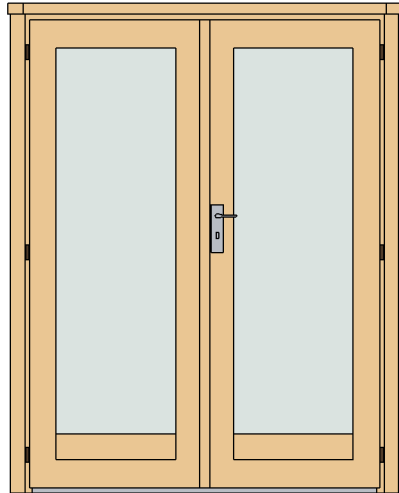

Door Schedule				
Model	Type	Width	Height	Count

CDD4R	Classic double door 4 right	1425	1900	1
-------	-----------------------------	------	------	---

DCB8	Door crossbar 8 optional	--	--	2
------	--------------------------	----	----	---

Window Schedule				
Model	Type	Width	Height	Count

CW21R	Classic window 21 right	515	1890	2
-------	-------------------------	-----	------	---

WCB8	Window crossbar 8 optional	--	--	2
------	----------------------------	----	----	---

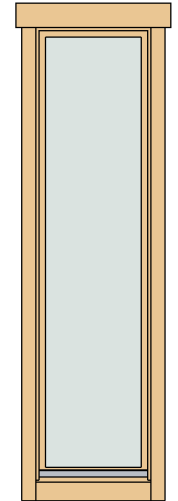

Fasteners/Extras		
Name	Type	Count

Hitblock	300-400 mm	
Adjustable post foot		1
Bolts	M8 x 70	18
Nails	1,4 x 40	30
Screws	5,0 x 70	60
Screws	6,0 x 140	100
Screws	4,0 x 40	780

Type	Count	Length
Windboard 18x40	6	2200





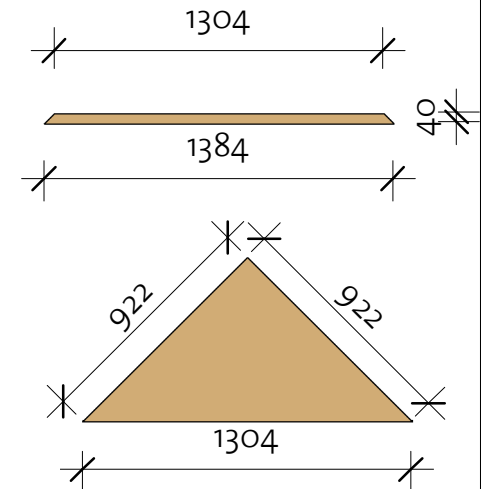

Ceiling detail 40x120	CD	1
Ceiling triangle	CT	1





Atlanta 2 40 (280x556)

List of all items 1

Impregnated foundation beams				
Mark	Type	Profile	Count	Length
IFB1	IFB 40x70		6	2750
IFB2	IFB 40x70		1	2224
IFB3	IFB 40x70		1	1845
IFB4	IFB 40x70		1	1805
IFB5	IFB 40x70		2	1376
IFB6	IFB 40x70		1	2720
IFB7	IFB 40x70		1	375

Roof				
Mark	Type	Profile	Count	Length
RFB1	40x85		10	1790
RFB2	40x85		4	1316
RFB3	40x85		4	1316
RFC	18x95		4	2025
RFR1	40x120		1	3340
RFR2	40x94		2	2431
RFR3	40x94		2	2431

Floor Schedule				
Mark	Type	Profile	Count	Length
FB 1	FB 17x114		1	1837
FB 2	FB 17x114		1	1951
FB 3	FB 17x114		1	2065
FB 4	FB 17x114		1	2179
FB 5	FB 17x114		1	2293
FB 6	FB 17x114		1	2407
FB 7	FB 17x114		1	2521
FB 8	FB 17x114		1	2635
FB 9	FB 17x114		16	2717
FB 10	FB 17x114		1	2717

BB	BB 20x40		4	2800
----	-------------	---	---	------

Columns			
Mark	Type	Length	Count

CM1	Post 80x70	2021	1
-----	------------	------	---

Fascia Schedule				
Mark	Type	Profile	Count	Length
RF1	Roof Fascia 18x120		2	2982
RF2	Roof Fascia 18x120		2	3061
RF3	Roof Fascia 18x120		2	3319

Atlanta 2 40 (280x556)

List of all items 2

Roofboards				
Mark	Type	Profile	Count	Length
RB 1	RoofBoard 17x114		2	165
RB 2	RoofBoard 17x114		2	376
RB 3	RoofBoard 17x114		2	586
RB 4	RoofBoard 17x114		2	797
RB 5	RoofBoard 17x114		2	1008
RB 6	RoofBoard 17x114		2	1218
RB 7	RoofBoard 17x114		2	1429
RB 8	RoofBoard 17x114		2	1640
RB 9	RoofBoard 17x114		2	1850
RB 10	RoofBoard 17x114		2	2061
RB 11	RoofBoard 17x114		2	2272
RB 12	RoofBoard 17x114		2	2482
RB 13	RoofBoard 17x114		2	2693
RB 14	RoofBoard 17x114		2	2904
RB 15	RoofBoard 17x114		2	3114
RB 16	RoofBoard 17x84		2	3269
RB 17	RoofBoard 17x114		2	2969
RB 18	RoofBoard 17x114		2	3180
RB 19	RoofBoard 17x114		2	3390
RB 20	RoofBoard 17x114		2	3601
RB 21	RoofBoard 17x114		2	3812
RB 22	RoofBoard 17x114		2	4022
RB 23	RoofBoard 17x114		2	4233
RB 24	RoofBoard 17x114		2	4444
RB 25	RoofBoard 17x114		2	4654
RB 26	RoofBoard 17x114		2	4865
RB 27	RoofBoard 17x114		2	2578
RB 28	RoofBoard 17x114		2	2683
RB 29	RoofBoard 17x114		2	2788
RB 30	RoofBoard 17x114		2	2814
RB 31	RoofBoard 17x114		2	2919
RB 32	RoofBoard 17x59		2	3052
RB 33	RoofBoard 17x59		2	2973
RB 34	RoofBoard 17x114		2	2894
RB 35	RoofBoard 17x114		2	2999
RB 36	RoofBoard 17x114		2	2708
RB 37	RoofBoard 17x114		2	2603
RB 38	RoofBoard 17x114		2	2498

Atlanta 2 40 (280x556)

List of all items 3

Wall 1			
Mark	Profile	Count	Cut Length

1LG 1	40x114	17	650
1LG 2	40x114	1	3000
1LG 3	40x114	1	3000
1TL 1	40x63	1	902
1TL 2	40x63	1	860
1TL 3	40x63	1	902
1TL 4	40x57 TL	1	3000

Wall 3			
Mark	Profile	Count	Cut Length

3LG 1	40x114	19	3000
3TL 1	40x63	1	902
3TL 2	40x63	1	860
3TL 3	40x63	1	902
3TL 4	40x57 TL	1	3000

Wall A			
Mark	Profile	Count	Cut Length

ABL 1	40x57	1	5760
ALG 1	40x114	18	5760
ALG 2	40x114	1	5760
ATL 1	40x63	1	902
ATL 2	40x63	1	902
ATL 3	40x63	2	640
ATL 4	40x63	2	620
ATL 5	40x63	2	430

Wall 2			
Mark	Profile	Count	Cut Length

2LG 1 *	40x114	1	547
2LG 2	40x114	16	730
2LG 3	40x114	16	591
2LG 4 *	40x114	1	1098
2LG 5 *	40x114	1	1648
2LG 6 *	40x114	1	2199
2LG 7 *	40x114	1	2749
2LG 8 *	40x114	1	3000
2LG 9	40x114	1	3000
2LG 10	40x114	1	1841
2LG 11	40x114	1	3000
2LG 11/M	40x114	1	3000

* Gable - delivered premounted

Atlanta 2 40 (280x556)

List of all items 4



Wall B			
Mark	Profile	Count	Cut Length

BBL 1	40x57	1	1841
BLG 1	40x114	16	591
BLG 2	40x114	17	730
BLG 3	40x114	1	688

Wall B			
Mark	Profile	Count	Cut Length

BLG 3/M	40x114	1	688
BLG 4	40x114	1	5760
BLG 5	40x114	1	5760
BTL 1	40x63	1	902
BTL 2	40x63	1	902
BTL 3	40x63	2	640
BTL 4	40x63	2	620
BTL 5	40x63	2	430

Log Profiles	
Profile	Profile

40x57	
40x57 TL	
40x63	
40x114	