

Atlanta 2 40 (110 1/4" x 218 7/8")

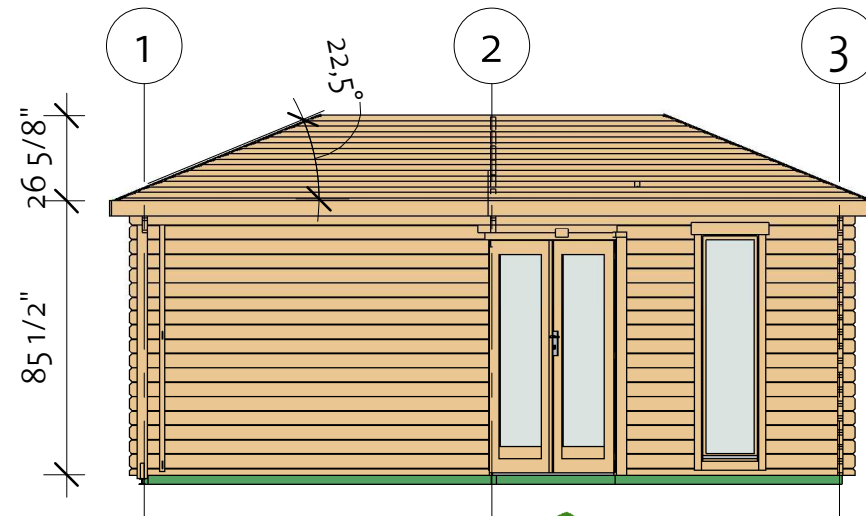
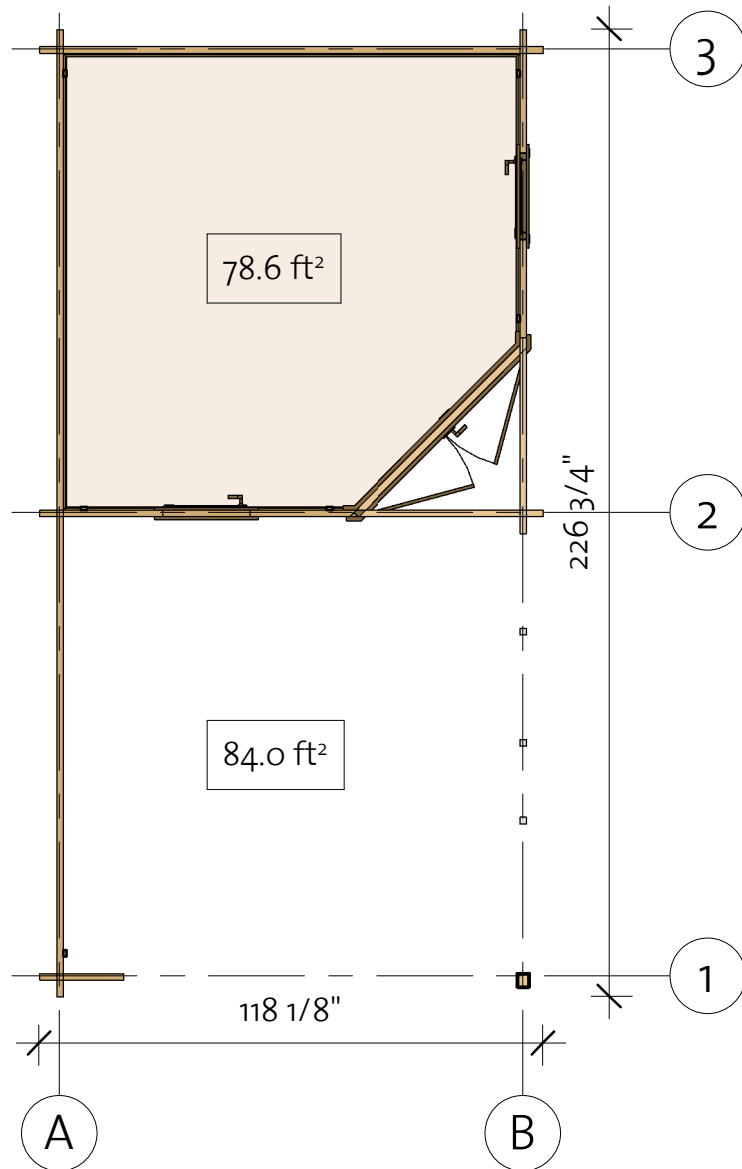

4200016_210921

EZ Log Structures
Do-It-Yourself Building Kits

Atlanta 2 40 (110 1/4"x218 7/8")

Foundation

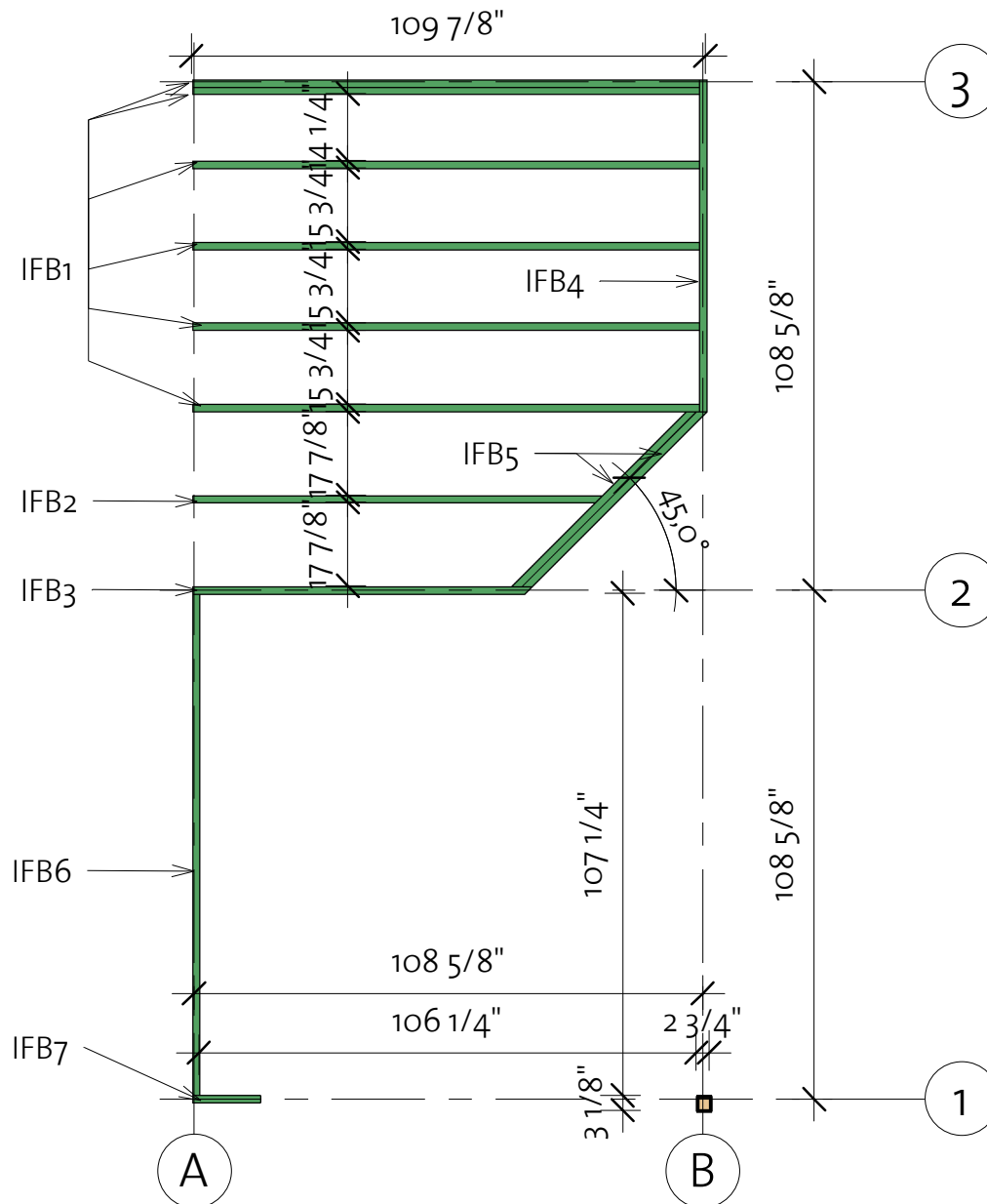

| Impregnated foundation beams | | | | |
|------------------------------|------|---------|-------|--------|
| Mark | Type | Profile | Count | Length |

| | | | | |
|------|--------------|---|---|----------|
| IFB1 | IFB 40x70 |  | 6 | 108 1/4" |
| IFB2 | IFB 40x70 | | 1 | 87 5/8" |
| IFB3 | IFB 40x70 | | 1 | 72 5/8" |
| IFB4 | IFB 40x70 | | 1 | 71 1/8" |
| IFB5 | IFB 40x70 | | 2 | 54 1/4" |
| IFB6 | IFB 40x70 | | 1 | 107 1/8" |
| IFB7 | IFB 40x70 | | 1 | 14 3/4" |

Atlanta 2 40 (110 1/4"x218 7/8")

Floor Plan (I) Baseboard

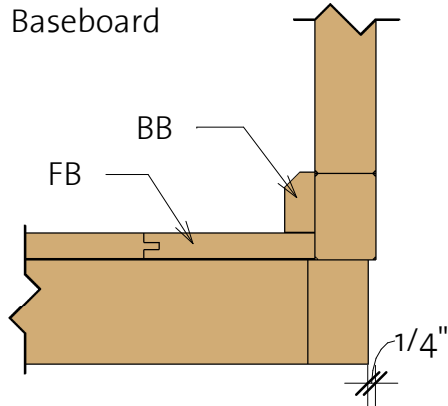

| Floor Schedule | | | | |
|----------------|------|---------|-------|--------|
| Mark | Type | Profile | Count | Length |

| | | | | |
|-------|-----------|---|----|----------|
| FB 1 | FB 17x114 |  | 1 | 72 3/8" |
| FB 2 | FB 17x114 | | 1 | 76 3/4" |
| FB 3 | FB 17x114 | | 1 | 81 1/4" |
| FB 4 | FB 17x114 | | 1 | 85 3/4" |
| FB 5 | FB 17x114 | | 1 | 90 1/4" |
| FB 6 | FB 17x114 | | 1 | 94 3/4" |
| FB 7 | FB 17x114 | | 1 | 99 1/4" |
| FB 8 | FB 17x114 | | 1 | 103 3/4" |
| FB 9 | FB 17x114 | | 16 | 107" |
| FB 10 | FB 17x114 | | 1 | 107" |

| | | | | |
|----|----------|---|---|----------|
| BB | BB 20x40 |  | 4 | 110 1/4" |
|----|----------|---|---|----------|

4200016_210921

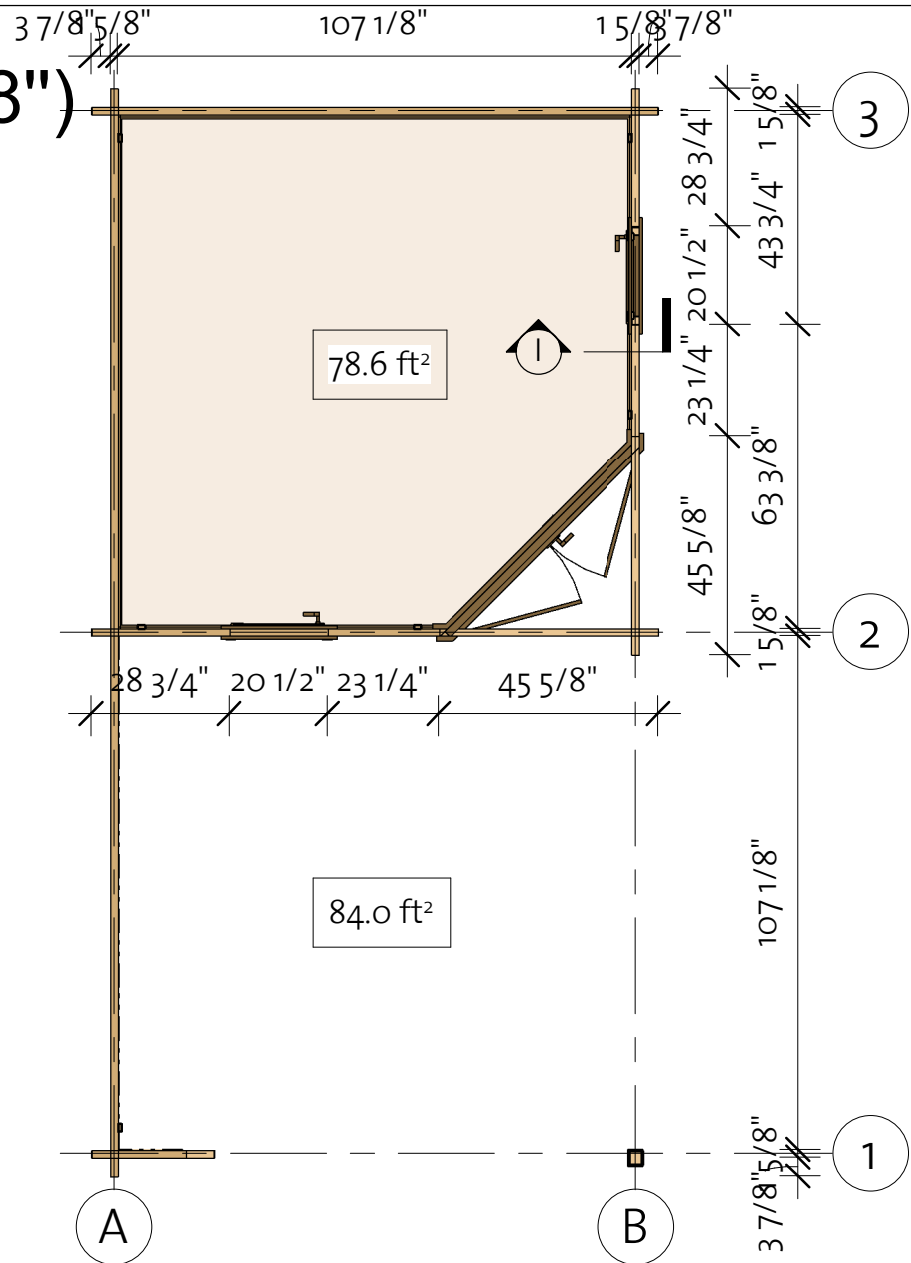

Atlanta 2 40 (110 1/4"x218 7/8")

Wall 1

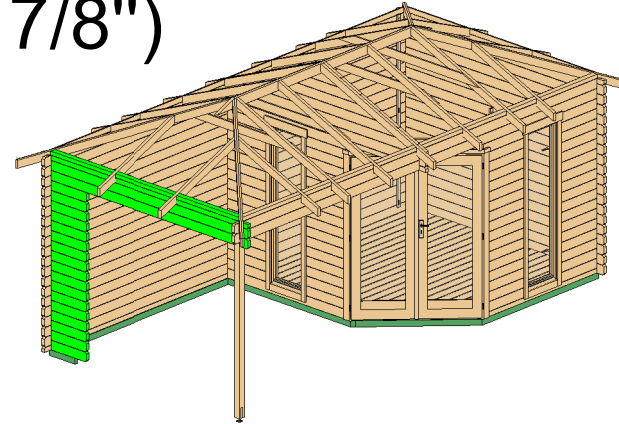

| Wall 1 | | | |
|--------|----------|-------|------------|
| Mark | Profile | Count | Cut Length |
| 1LG 1 | 40x114 | 17 | 25 5/8" |
| 1LG 2 | 40x114 | 1 | 118 1/8" |
| 1LG 3 | 40x114 | 1 | 118 1/8" |
| 1TL 1 | 40x63 | 1 | 35 1/2" |
| 1TL 2 | 40x63 | 1 | 33 7/8" |
| 1TL 3 | 40x63 | 1 | 35 1/2" |
| 1TL 4 | 40x57 TL | 1 | 118 1/8" |

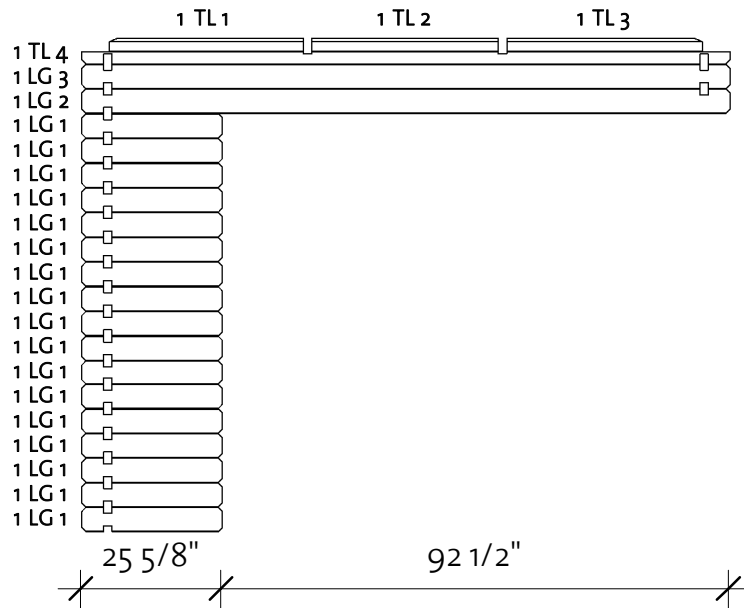

| Log Profile Wall 1 | |
|--------------------|---------|
| Profile | Profile |

| | |
|----------|--|
| 40x57 TL | |
| 40x63 | |
| 40x114 | |

Atlanta 2 40 (110 1/4"x218 7/8")

Wall 2

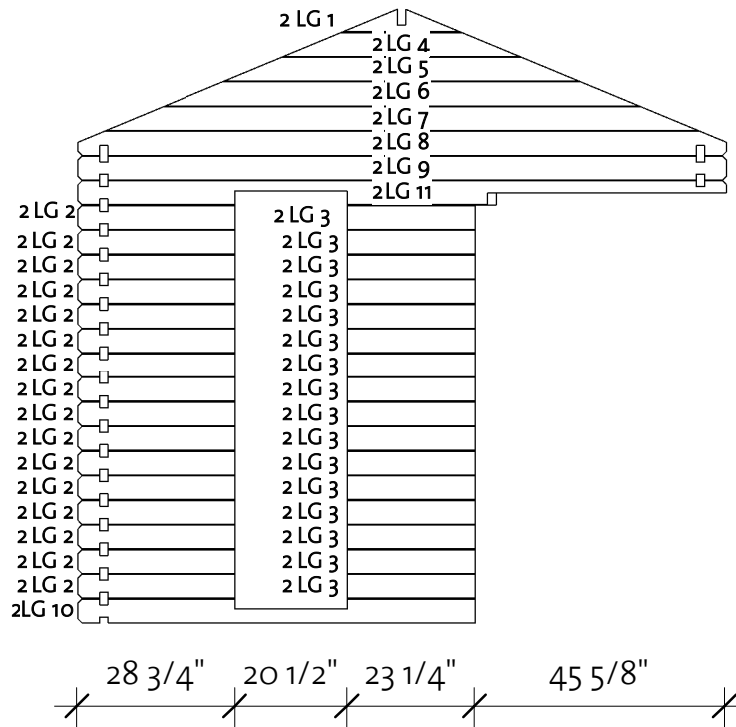
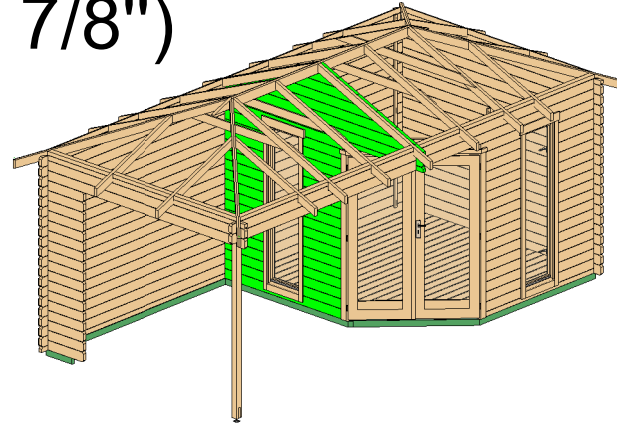

| Wall 2 | | | |
|--------|---------|-------|------------|
| Mark | Profile | Count | Cut Length |

| | | | |
|----------|--------|----|----------|
| 2LG 1 * | 40X114 | 1 | 21 1/2" |
| 2LG 2 | 40X114 | 16 | 28 3/4" |
| 2LG 3 | 40X114 | 16 | 23 1/4" |
| 2LG 4 * | 40X114 | 1 | 43 1/4" |
| 2LG 5 * | 40X114 | 1 | 64 7/8" |
| 2LG 6 * | 40X114 | 1 | 86 1/2" |
| 2LG 7 * | 40X114 | 1 | 108 1/4" |
| 2LG 8 * | 40X114 | 1 | 118 1/8" |
| 2LG 9 | 40X114 | 1 | 118 1/8" |
| 2LG 10 | 40X114 | 1 | 72 1/2" |
| 2LG 11 | 40X114 | 1 | 118 1/8" |
| 2LG 11/M | 40X114 | 1 | 118 1/8" |

* Gable - delivered premounted

| Log Profile Wall 2 | |
|--------------------|---------|
| Profile | Profile |

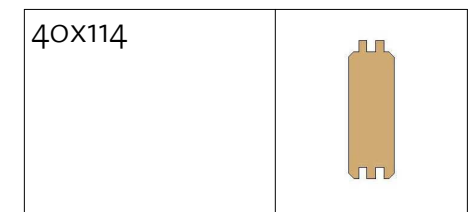

Atlanta 2 40 (110 1/4"x218 7/8")

Wall 3

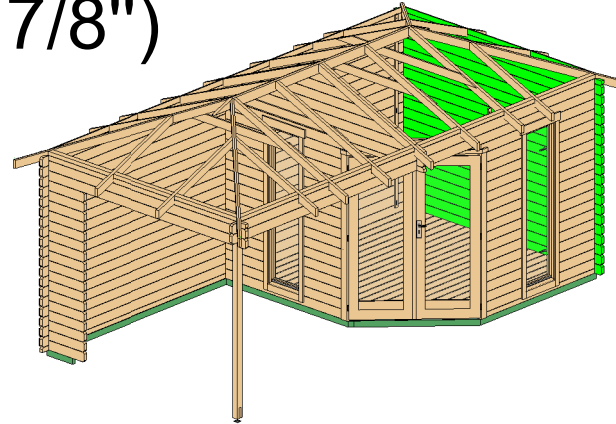

| Wall 3 | | | |
|--------|---------|-------|------------|
| Mark | Profile | Count | Cut Length |

| | | | |
|-------|----------|----|----------|
| 3LG 1 | 40x114 | 19 | 118 1/8" |
| 3TL 1 | 40x63 | 1 | 35 1/2" |
| 3TL 2 | 40x63 | 1 | 33 7/8" |
| 3TL 3 | 40x63 | 1 | 35 1/2" |
| 3TL 4 | 40x57 TL | 1 | 118 1/8" |

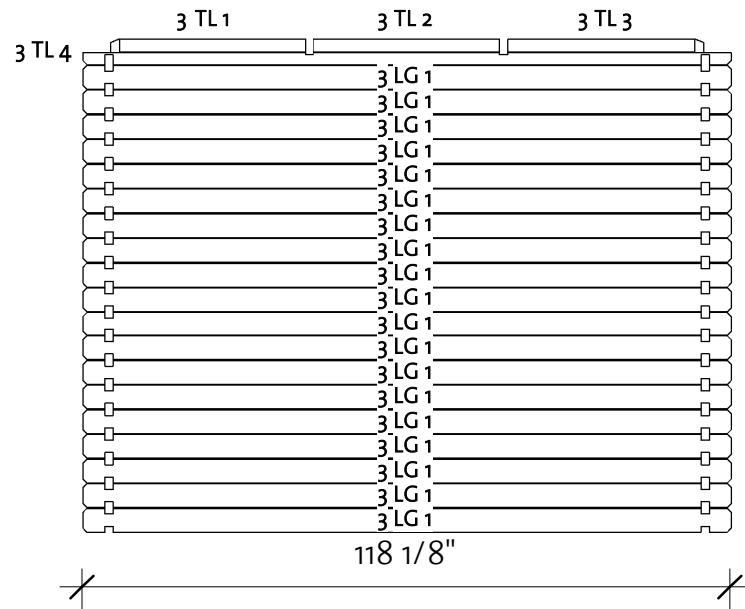

| Log Profile Wall 3 | |
|--------------------|---------|
| Profile | Profile |

| | |
|----------|--|
| 40x57 TL | |
| 40x63 | |
| 40x114 | |

Atlanta 2 40 (110 1/4"x218 7/8")

Wall B

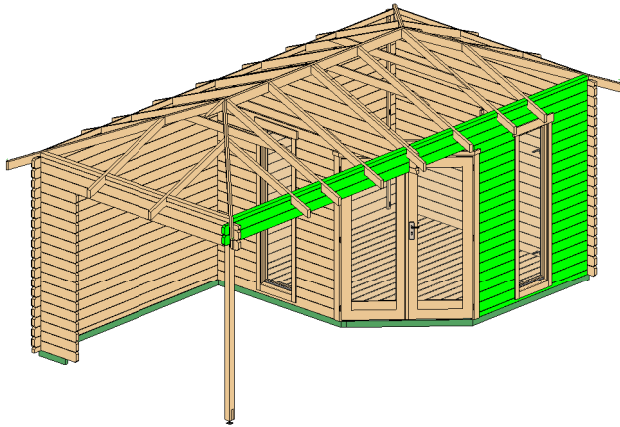

| Wall B | | | |
|--------|---------|-------|------------|
| Mark | Profile | Count | Cut Length |

| | | | |
|-------|--------|----|---------|
| BBL 1 | 40x57 | 1 | 72 1/2" |
| BLG 1 | 40x114 | 16 | 23 1/4" |
| BLG 2 | 40x114 | 17 | 28 3/4" |
| BLG 3 | 40x114 | 1 | 27 1/8" |

| Wall B | | | |
|--------|---------|-------|------------|
| Mark | Profile | Count | Cut Length |

| | | | |
|---------|--------|---|----------|
| BLG 3/M | 40x114 | 1 | 27 1/8" |
| BLG 4 | 40x114 | 1 | 226 3/4" |
| BLG 5 | 40x114 | 1 | 226 3/4" |
| BTL 1 | 40x63 | 1 | 35 1/2" |
| BTL 2 | 40x63 | 1 | 35 1/2" |
| BTL 3 | 40x63 | 2 | 25 1/4" |
| BTL 4 | 40x63 | 2 | 24 3/8" |
| BTL 5 | 40x63 | 2 | 16 7/8" |

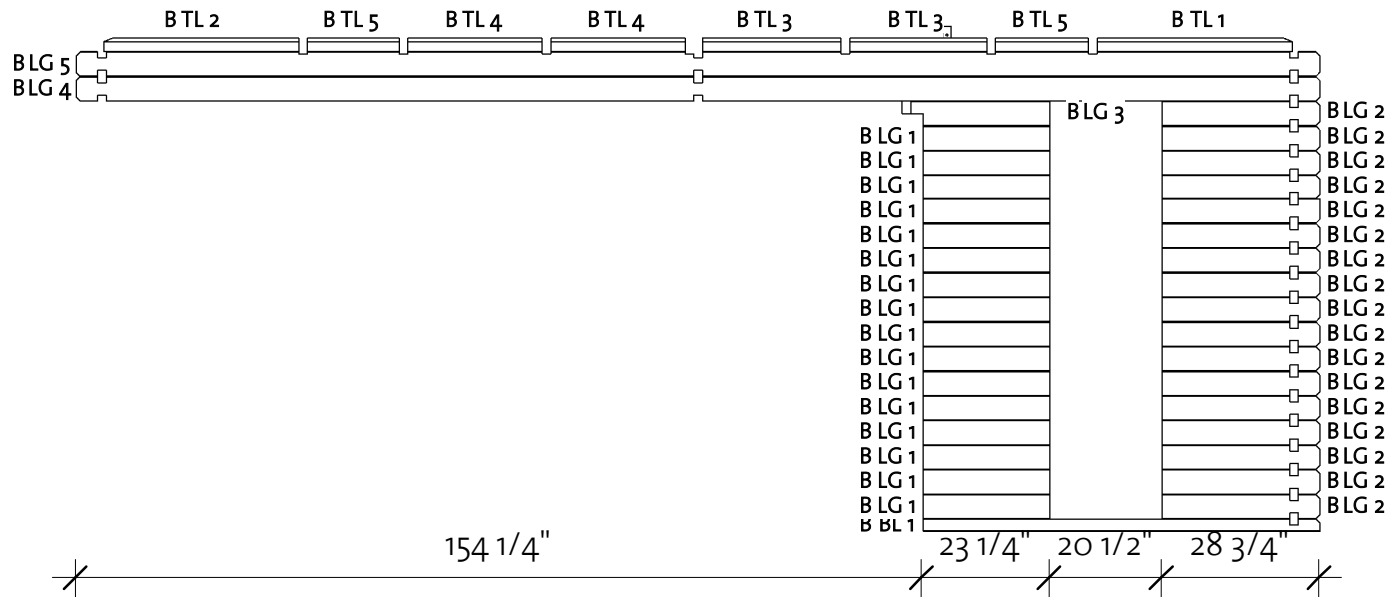

| Log Profile Wall B | |
|--------------------|---------|
| Profile | Profile |

| | |
|--------|--|
| 40x63 | |
| 40x114 | |
| 40x57 | |

Atlanta 2 40 (110 1/4"x218 7/8")

Roof 1

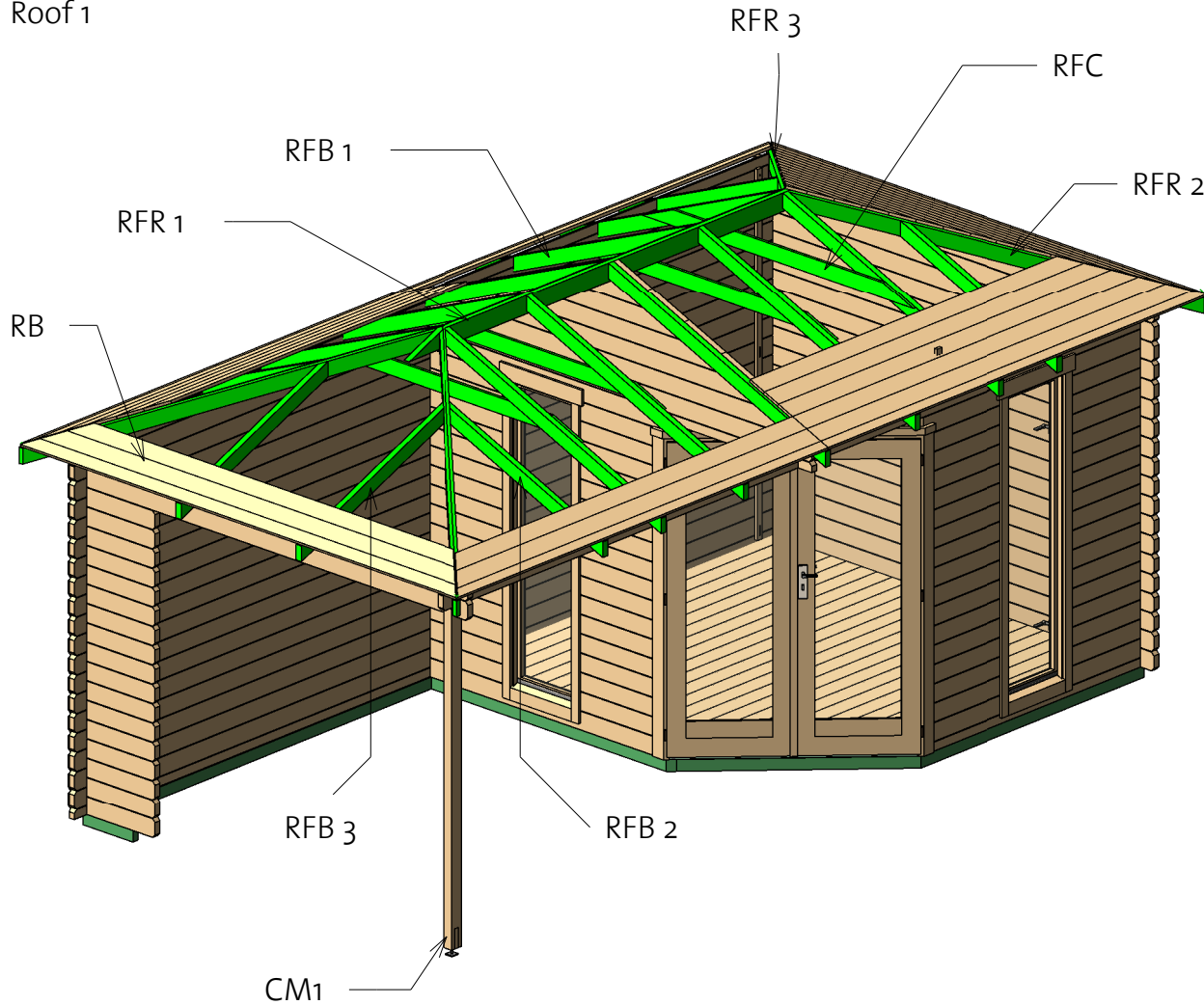

| Roof | | | | |
|------|------|---------|-------|--------|
| Mark | Type | Profile | Count | Length |

| | | | | |
|------|--------|--|----|----------|
| RFB1 | 40x85 | | 10 | 70 1/2" |
| RFB2 | 40x85 | | 4 | 51 7/8" |
| RFB3 | 40x85 | | 4 | 51 7/8" |
| RFC | 18x95 | | 4 | 79 3/4" |
| RFR1 | 40x120 | | 1 | 131 1/2" |
| RFR2 | 40x94 | | 2 | 95 3/4" |
| RFR3 | 40x94 | | 2 | 95 3/4" |

| Columns | | | |
|---------|------|--------|-------|
| Mark | Type | Length | Count |

| | | | |
|-----|------------|---------|---|
| CM1 | Post 80x70 | 79 5/8" | 1 |
|-----|------------|---------|---|

| | | |
|----------------------|----|----|
| Adjustable post foot | 0" | 46 |
|----------------------|----|----|

Atlanta 2 40 (110 1/4"x218 7/8")

Roof 2

| Roofboards | | | | |
|------------|------|---------|-------|--------|
| Mark | Type | Profile | Count | Length |

| | | | | |
|-------|------------------|---|---|----------|
| RB 1 | RoofBoard 17x114 |  | 2 | 6 1/2" |
| RB 2 | RoofBoard 17x114 | | 2 | 14 3/4" |
| RB 3 | RoofBoard 17x114 | | 2 | 23 1/8" |
| RB 4 | RoofBoard 17x114 | | 2 | 31 3/8" |
| RB 5 | RoofBoard 17x114 | | 2 | 39 5/8" |
| RB 6 | RoofBoard 17x114 | | 2 | 48" |
| RB 7 | RoofBoard 17x114 | | 2 | 56 1/4" |
| RB 8 | RoofBoard 17x114 | | 2 | 64 1/2" |
| RB 9 | RoofBoard 17x114 | | 2 | 72 7/8" |
| RB 10 | RoofBoard 17x114 | | 2 | 81 1/8" |
| RB 11 | RoofBoard 17x114 | | 2 | 89 3/8" |
| RB 12 | RoofBoard 17x114 | | 2 | 97 3/4" |
| RB 13 | RoofBoard 17x114 | | 2 | 106" |
| RB 14 | RoofBoard 17x114 | | 2 | 114 3/8" |
| RB 15 | RoofBoard 17x114 | | 2 | 122 5/8" |
| RB 16 | RoofBoard 17x84 | | 2 | 128 3/4" |
| RB 17 | RoofBoard 17x114 | | 2 | 116 7/8" |

| Roofboards | | | | |
|------------|------|---------|-------|--------|
| Mark | Type | Profile | Count | Length |

| | | | | |
|-------|------------------|--|---|----------|
| RB 18 | RoofBoard 17x114 | | 2 | 125 1/8" |
| RB 19 | RoofBoard 17x114 | | 2 | 133 1/2" |
| RB 20 | RoofBoard 17x114 | | 2 | 141 3/4" |
| RB 21 | RoofBoard 17x114 | | 2 | 150 1/8" |
| RB 22 | RoofBoard 17x114 | | 2 | 158 3/8" |
| RB 23 | RoofBoard 17x114 | | 2 | 166 5/8" |
| RB 24 | RoofBoard 17x114 | | 2 | 175" |
| RB 25 | RoofBoard 17x114 | | 2 | 183 1/4" |
| RB 26 | RoofBoard 17x114 | | 2 | 191 1/2" |
| RB 27 | RoofBoard 17x114 | | 2 | 101 1/2" |
| RB 28 | RoofBoard 17x114 | | 2 | 105 5/8" |
| RB 29 | RoofBoard 17x114 | | 2 | 109 3/4" |
| RB 30 | RoofBoard 17x114 | | 2 | 110 3/4" |
| RB 31 | RoofBoard 17x114 | | 2 | 114 7/8" |
| RB 32 | RoofBoard 17x59 | | 2 | 120 1/8" |
| RB 33 | RoofBoard 17x59 | | 2 | 117" |
| RB 34 | RoofBoard 17x114 | | 2 | 113 7/8" |
| RB 35 | RoofBoard 17x114 | | 2 | 118 1/8" |
| RB 36 | RoofBoard 17x114 | | 2 | 106 5/8" |
| RB 37 | RoofBoard 17x114 | | 2 | 102 1/2" |
| RB 38 | RoofBoard 17x114 | | 2 | 98 3/8" |

Atlanta 2 40 (110 1/4"x218 7/8")

Roof 3

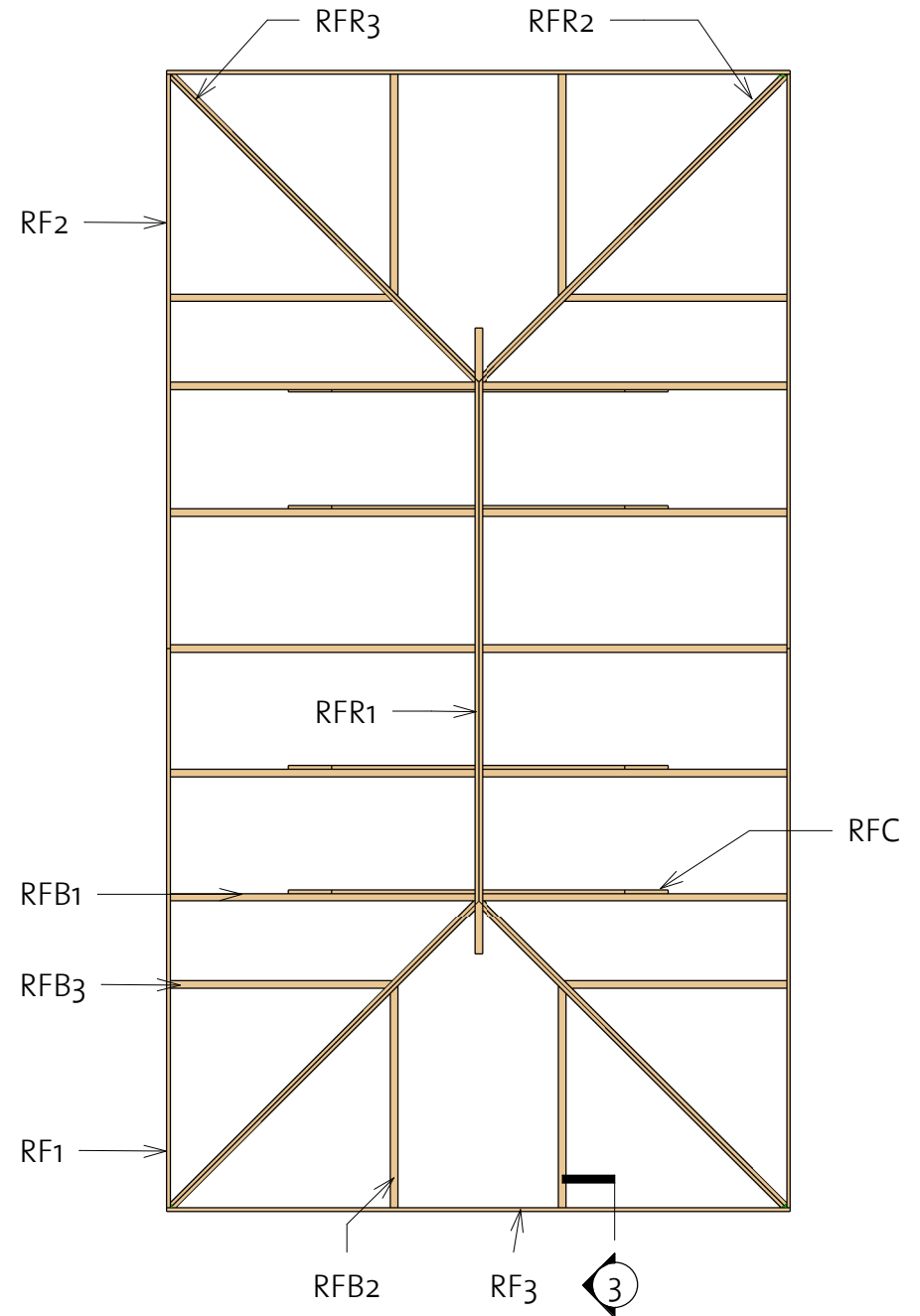
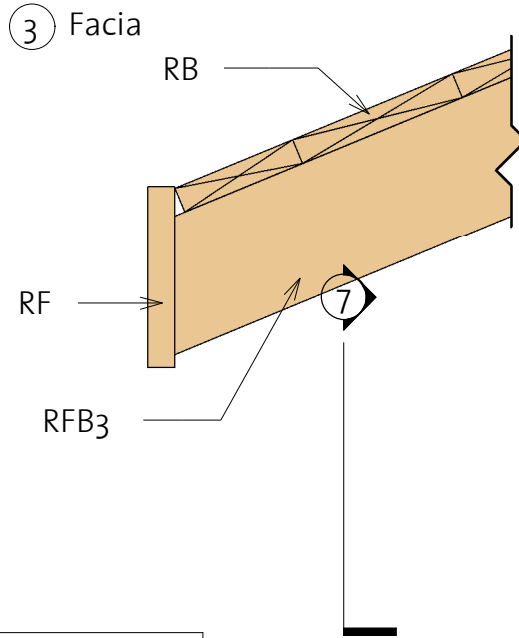
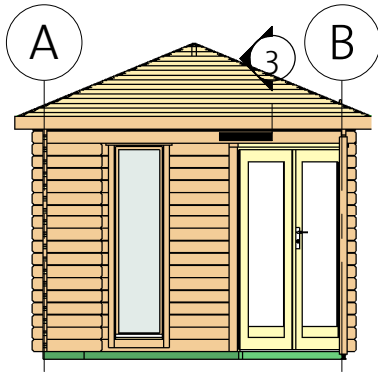

Fascia Schedule

| Mark | Type | Profile | Count | Length |
|------|-----------------------|---|-------|-------------|
| RF1 | Roof Fascia 18x120 |  | 2 | 117 3/8" |
| RF2 | Roof Fascia 18x120 | | 2 | 120 1/2" |
| RF3 | Roof Fascia 18x120 | | 2 | 130 5/8" |

4200016_210921

Atlanta 2 40 (110 1/4"x218 7/8")

Extras

- * Windows intended for tilt opening only!
- * Fenster zur Eröffnung nur zum Kippen vorgesehen!
- * Aknad on ette nähtud ainult kaldu avamiseks!

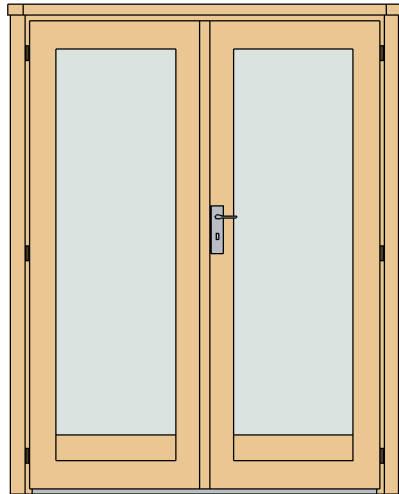

| Door Schedule | | | | |
|---------------|------|-------|--------|-------|
| Model | Type | Width | Height | Count |

| | | | | |
|-------|-----------------------------|---------|---------|---|
| CDD4R | Classic double door 4 right | 56 1/8" | 74 3/4" | 1 |
|-------|-----------------------------|---------|---------|---|

| | | | | |
|------|--------------------------|----|----|---|
| DCB8 | Door crossbar 8 optional | -- | -- | 2 |
|------|--------------------------|----|----|---|

| Window Schedule | | | | |
|-----------------|------|-------|--------|-------|
| Model | Type | Width | Height | Count |

| | | | | |
|-------|-------------------------|---------|---------|---|
| CW21R | Classic window 21 right | 20 1/4" | 74 3/8" | 2 |
|-------|-------------------------|---------|---------|---|

| | | | | |
|------|----------------------------|----|----|---|
| WCB8 | Window crossbar 8 optional | -- | -- | 2 |
|------|----------------------------|----|----|---|

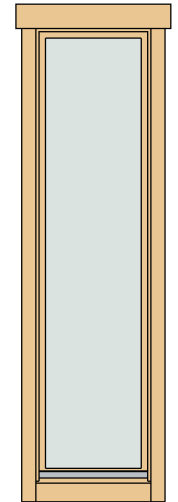

| Fasteners/Extras | | |
|------------------|------|-------|
| Name | Type | Count |

| | | |
|----------------------|------------|-----|
| Hitblock | 300-400 mm | |
| Adjustable post foot | | 1 |
| Bolts | M8 x 70 | 18 |
| Nails | 1,4 x 40 | 30 |
| Screws | 5,0 x 70 | 60 |
| Screws | 6,0 x 140 | 100 |
| Screws | 4,0 x 40 | 780 |

| Type | Count | Length |
|-----------------|-------|---------|
| Windboard 18x40 | 6 | 86 5/8" |

| | | |
|-----------------------|----|---|
| Ceiling detail 40x120 | CD | 1 |
| Ceiling triangle | CT | 1 |

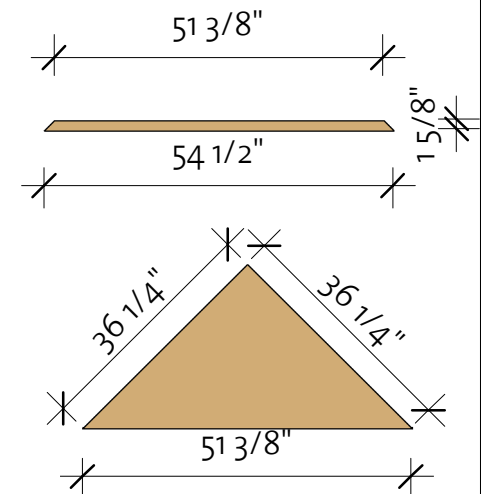



Atlanta 2 40 (110 1/4"x218 7/8")

List of all items 1



Impregnated foundation beams

| Mark | Type | Profile | Count | Length |
|------|--------------|---|-------|----------|
| IFB1 | IFB 40x70 |  | 6 | 108 1/4" |
| IFB2 | IFB 40x70 | | 1 | 87 5/8" |
| IFB3 | IFB 40x70 | | 1 | 72 5/8" |
| IFB4 | IFB 40x70 | | 1 | 71 1/8" |
| IFB5 | IFB 40x70 | | 2 | 54 1/4" |
| IFB6 | IFB 40x70 | | 1 | 107 1/8" |
| IFB7 | IFB 40x70 | | 1 | 14 3/4" |

Roof

| Mark | Type | Profile | Count | Length |
|------|--------|---|-------|----------|
| RFB1 | 40x85 |  | 10 | 70 1/2" |
| RFB2 | 40x85 | | 4 | 51 7/8" |
| RFB3 | 40x85 | | 4 | 51 7/8" |
| RFC | 18x95 |  | 4 | 79 3/4" |
| RFR1 | 40x120 |  | 1 | 131 1/2" |
| RFR2 | 40x94 | | 2 | 95 3/4" |
| RFR3 | 40x94 | | 2 | 95 3/4" |

Floor Schedule

| Mark | Type | Profile | Count | Length |
|-------|-------------|---|-------|----------|
| FB 1 | FB 17x114 |  | 1 | 72 3/8" |
| FB 2 | FB 17x114 | | 1 | 76 3/4" |
| FB 3 | FB 17x114 | | 1 | 81 1/4" |
| FB 4 | FB 17x114 | | 1 | 85 3/4" |
| FB 5 | FB 17x114 | | 1 | 90 1/4" |
| FB 6 | FB 17x114 | | 1 | 94 3/4" |
| FB 7 | FB 17x114 | | 1 | 99 1/4" |
| FB 8 | FB 17x114 | | 1 | 103 3/4" |
| FB 9 | FB 17x114 | | 16 | 107" |
| FB 10 | FB 17x114 | | 1 | 107" |
| BB | BB 20x40 |  | 4 | 110 1/4" |

Columns

| Mark | Type | Length | Count |
|------|------------|---------|-------|
| CM1 | Post 80x70 | 79 5/8" | 1 |

Fascia Schedule

| Mark | Type | Profile | Count | Length |
|------|-----------------------|---|-------|----------|
| RF1 | Roof Fascia 18x120 |  | 2 | 117 3/8" |
| RF2 | Roof Fascia 18x120 | | 2 | 120 1/2" |
| RF3 | Roof Fascia 18x120 | | 2 | 130 5/8" |

Atlanta 2 40 (110 1/4"x218 7/8")

List of all items 2

| Roofboards | | | | |
|------------|------------------|---|-------|----------|
| Mark | Type | Profile | Count | Length |
| RB 1 | RoofBoard 17x114 |  | 2 | 6 1/2" |
| RB 2 | RoofBoard 17x114 | | 2 | 14 3/4" |
| RB 3 | RoofBoard 17x114 | | 2 | 23 1/8" |
| RB 4 | RoofBoard 17x114 | | 2 | 31 3/8" |
| RB 5 | RoofBoard 17x114 | | 2 | 39 5/8" |
| RB 6 | RoofBoard 17x114 | | 2 | 48" |
| RB 7 | RoofBoard 17x114 | | 2 | 56 1/4" |
| RB 8 | RoofBoard 17x114 | | 2 | 64 1/2" |
| RB 9 | RoofBoard 17x114 | | 2 | 72 7/8" |
| RB 10 | RoofBoard 17x114 | | 2 | 81 1/8" |
| RB 11 | RoofBoard 17x114 | | 2 | 89 3/8" |
| RB 12 | RoofBoard 17x114 | | 2 | 97 3/4" |
| RB 13 | RoofBoard 17x114 | | 2 | 106" |
| RB 14 | RoofBoard 17x114 | | 2 | 114 3/8" |
| RB 15 | RoofBoard 17x114 | | 2 | 122 5/8" |
| RB 16 | RoofBoard 17x84 | | 2 | 128 3/4" |
| RB 17 | RoofBoard 17x114 | | 2 | 116 7/8" |
| RB 18 | RoofBoard 17x114 | | 2 | 125 1/8" |
| RB 19 | RoofBoard 17x114 | | 2 | 133 1/2" |
| RB 20 | RoofBoard 17x114 | | 2 | 141 3/4" |
| RB 21 | RoofBoard 17x114 | | 2 | 150 1/8" |
| RB 22 | RoofBoard 17x114 | | 2 | 158 3/8" |
| RB 23 | RoofBoard 17x114 | | 2 | 166 5/8" |
| RB 24 | RoofBoard 17x114 | | 2 | 175" |
| RB 25 | RoofBoard 17x114 | | 2 | 183 1/4" |
| RB 26 | RoofBoard 17x114 | | 2 | 191 1/2" |
| RB 27 | RoofBoard 17x114 | | 2 | 101 1/2" |
| RB 28 | RoofBoard 17x114 | | 2 | 105 5/8" |
| RB 29 | RoofBoard 17x114 | | 2 | 109 3/4" |
| RB 30 | RoofBoard 17x114 | | 2 | 110 3/4" |
| RB 31 | RoofBoard 17x114 | | 2 | 114 7/8" |
| RB 32 | RoofBoard 17x59 | | 2 | 120 1/8" |
| RB 33 | RoofBoard 17x59 | | 2 | 117" |
| RB 34 | RoofBoard 17x114 | | 2 | 113 7/8" |
| RB 35 | RoofBoard 17x114 | | 2 | 118 1/8" |
| RB 36 | RoofBoard 17x114 | | 2 | 106 5/8" |
| RB 37 | RoofBoard 17x114 | | 2 | 102 1/2" |
| RB 38 | RoofBoard 17x114 | | 2 | 98 3/8" |

Atlanta 2 40 (110 1/4"x218 7/8")

List of all items 3

| Wall 1 | | | |
|--------|---------|-------|------------|
| Mark | Profile | Count | Cut Length |

| | | | |
|-------|-------------|----|----------|
| 1LG 1 | 40x114 | 17 | 25 5/8" |
| 1LG 2 | 40x114 | 1 | 118 1/8" |
| 1LG 3 | 40x114 | 1 | 118 1/8" |
| 1TL 1 | 40x63 | 1 | 35 1/2" |
| 1TL 2 | 40x63 | 1 | 33 7/8" |
| 1TL 3 | 40x63 | 1 | 35 1/2" |
| 1TL 4 | 40x57 TL | 1 | 118 1/8" |

| Wall 3 | | | |
|--------|---------|-------|------------|
| Mark | Profile | Count | Cut Length |

| | | | |
|-------|-------------|----|----------|
| 3LG 1 | 40x114 | 19 | 118 1/8" |
| 3TL 1 | 40x63 | 1 | 35 1/2" |
| 3TL 2 | 40x63 | 1 | 33 7/8" |
| 3TL 3 | 40x63 | 1 | 35 1/2" |
| 3TL 4 | 40x57 TL | 1 | 118 1/8" |

| Wall A | | | |
|--------|---------|-------|------------|
| Mark | Profile | Count | Cut Length |

| | | | |
|-------|--------|----|----------|
| ABL 1 | 40x57 | 1 | 226 3/4" |
| ALG 1 | 40x114 | 18 | 226 3/4" |
| ALG 2 | 40x114 | 1 | 226 3/4" |
| ATL 1 | 40x63 | 1 | 35 1/2" |
| ATL 2 | 40x63 | 1 | 35 1/2" |
| ATL 3 | 40x63 | 2 | 25 1/4" |
| ATL 4 | 40x63 | 2 | 24 3/8" |
| ATL 5 | 40x63 | 2 | 16 7/8" |

| Wall 2 | | | |
|--------|---------|-------|------------|
| Mark | Profile | Count | Cut Length |

| | | | |
|----------|--------|----|----------|
| 2LG 1 * | 40x114 | 1 | 21 1/2" |
| 2LG 2 | 40x114 | 16 | 28 3/4" |
| 2LG 3 | 40x114 | 16 | 23 1/4" |
| 2LG 4 * | 40x114 | 1 | 43 1/4" |
| 2LG 5 * | 40x114 | 1 | 64 7/8" |
| 2LG 6 * | 40x114 | 1 | 86 1/2" |
| 2LG 7 * | 40x114 | 1 | 108 1/4" |
| 2LG 8 * | 40x114 | 1 | 118 1/8" |
| 2LG 9 | 40x114 | 1 | 118 1/8" |
| 2LG 10 | 40x114 | 1 | 72 1/2" |
| 2LG 11 | 40x114 | 1 | 118 1/8" |
| 2LG 11/M | 40x114 | 1 | 118 1/8" |

* Gable - delivered premounted

Atlanta 2 40 (110 1/4"x218 7/8")

List of all items 4



| Wall B | | | |
|--------|---------|-------|------------|
| Mark | Profile | Count | Cut Length |

| | | | |
|-------|--------|----|---------|
| BBL 1 | 40x57 | 1 | 72 1/2" |
| BLG 1 | 40x114 | 16 | 23 1/4" |
| BLG 2 | 40x114 | 17 | 28 3/4" |
| BLG 3 | 40x114 | 1 | 27 1/8" |

| Wall B | | | |
|--------|---------|-------|------------|
| Mark | Profile | Count | Cut Length |

| | | | |
|---------|--------|---|----------|
| BLG 3/M | 40x114 | 1 | 27 1/8" |
| BLG 4 | 40x114 | 1 | 226 3/4" |
| BLG 5 | 40x114 | 1 | 226 3/4" |
| BTL 1 | 40x63 | 1 | 35 1/2" |
| BTL 2 | 40x63 | 1 | 35 1/2" |
| BTL 3 | 40x63 | 2 | 25 1/4" |
| BTL 4 | 40x63 | 2 | 24 3/8" |
| BTL 5 | 40x63 | 2 | 16 7/8" |

| Log Profiles | |
|--------------|---------|
| Profile | Profile |

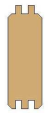
| | |
|----------|---|
| 40x57 |  |
| 40x57 TL |  |
| 40x63 |  |
| 40x114 |  |