

# Atlantata 1 40 (110 1/4" x 218 7/8")

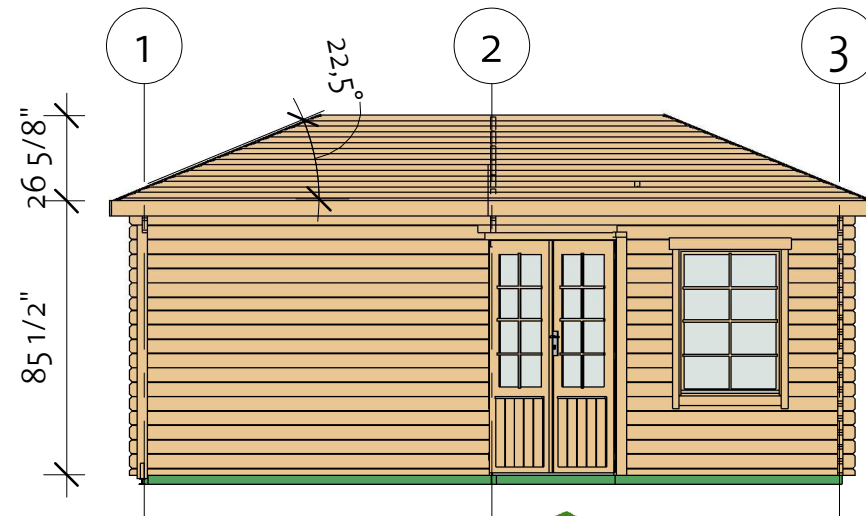

4200015\_220906

**EZ** Log Structures  
Do-It-Yourself Building Kits

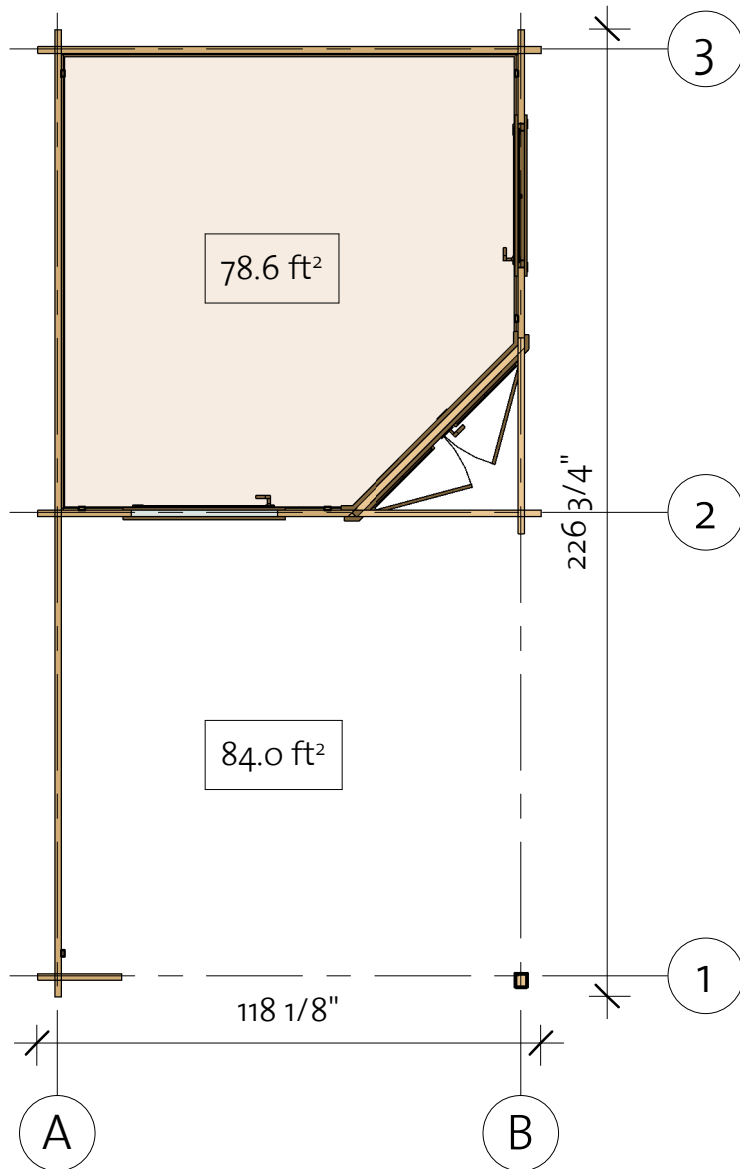

# Atlanta 1 40 (110 1/4"x218 7/8")

Floor Plan (I) Baseboard

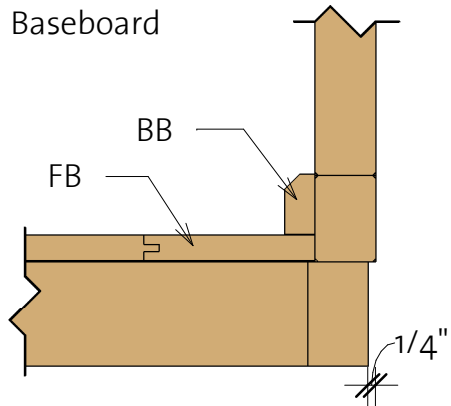

Floor Schedule

Mark	Type	Profile	Count	Length
------	------	---------	-------	--------

FB 1	FB 17x114		1	72 3/8"
FB 2	FB 17x114		1	76 3/4"
FB 3	FB 17x114		1	81 1/4"
FB 4	FB 17x114		1	85 3/4"
FB 5	FB 17x114		1	90 1/4"
FB 6	FB 17x114		1	94 3/4"
FB 7	FB 17x114		1	99 1/4"
FB 8	FB 17x114		1	103 3/4"
FB 9	FB 17x114		16	107"
FB 10	FB 17x114		1	107"

BB	BB 20x40		4	110 1/4"
----	----------	--	---	----------

4200015\_220906

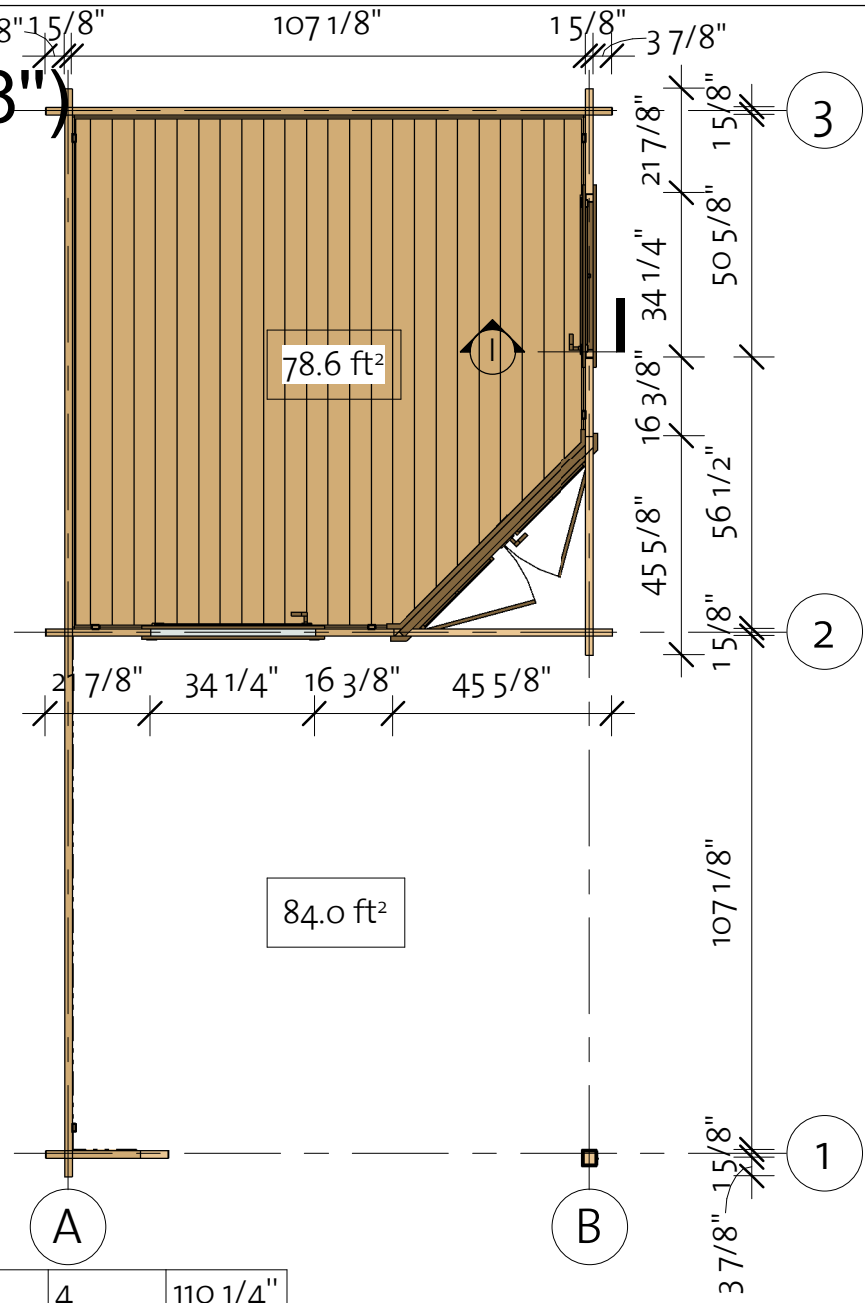

# Atlanata 1 40 (110 1/4"x218 7/8")

Wall 1

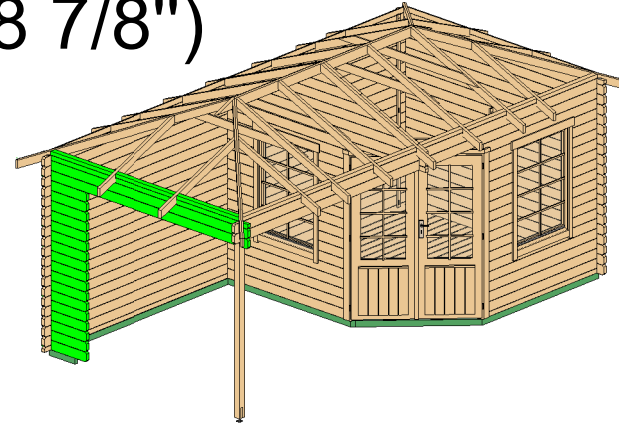

Wall 1			
Mark	Profile	Count	Cut Length
1LG 1	40x114	17	25 5/8"
1LG 2	40x114	1	118 1/8"
1LG 3	40x114	1	118 1/8"
1TL 1	40x63	1	35 1/2"
1TL 2	40x63	1	33 7/8"
1TL 3	40x63	1	35 1/2"
1TL 4	40x57 TL	1	118 1/8"

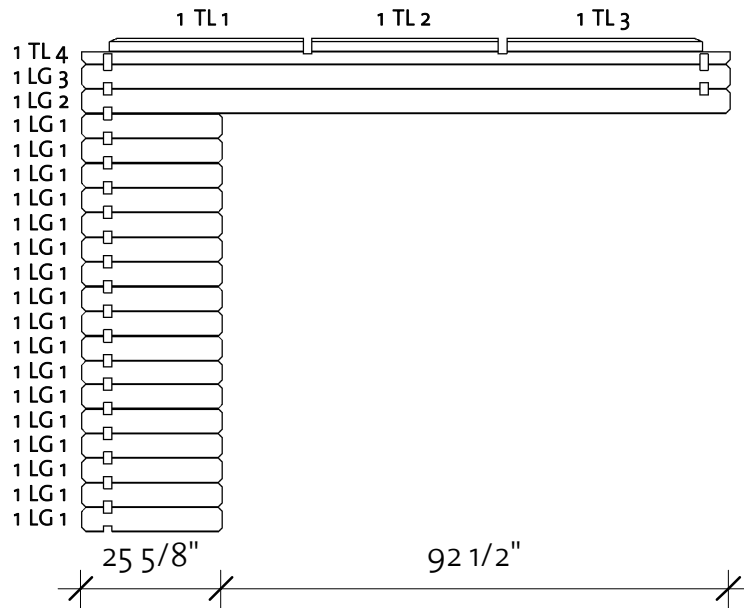

Log Profile Wall 1	
Profile	Profile

40x57 TL	
40x63	
40x114	



# Atlanata 1 40 (110 1/4"x218 7/8")

Wall 3

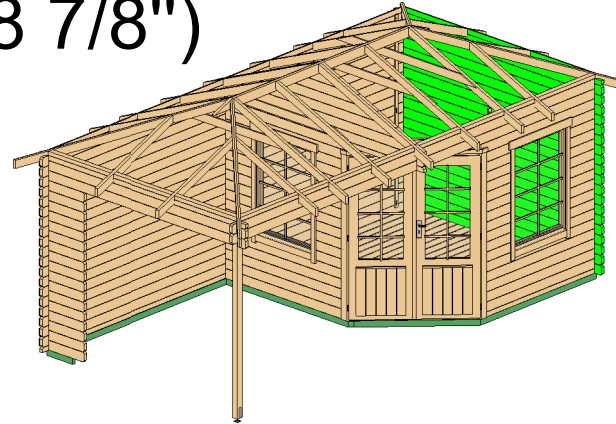

Wall 3			
Mark	Profile	Count	Cut Length
3LG 1	40x114	19	118 1/8"
3TL 1	40x63	1	35 1/2"
3TL 2	40x63	1	33 7/8"
3TL 3	40x63	1	35 1/2"
3TL 4	40x57 TL	1	118 1/8"

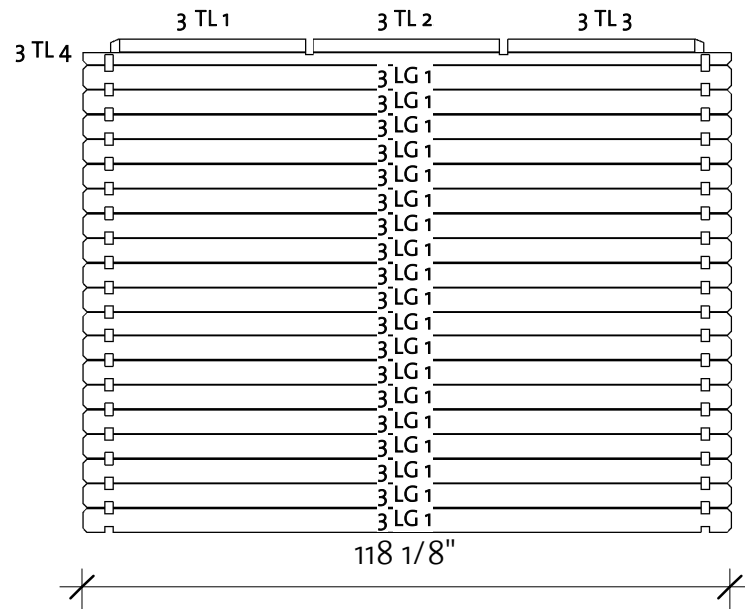

Log Profile Wall 3	
Profile	Profile

40x57 TL	
40x63	
40x114	

# Atlanta 1 40 (110 1/4"x218 7/8")

Wall A

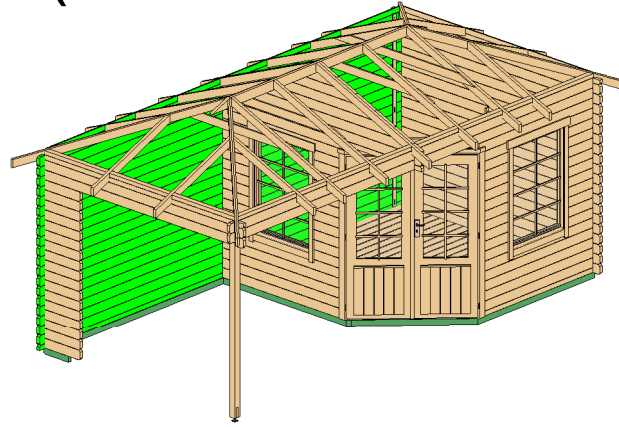

Wall A			
Mark	Profile	Count	Cut Length

ABL 1	40x57	1	226 3/4"
ALG 1	40x114	18	226 3/4"
ALG 2	40x114	1	226 3/4"
ATL 1	40x63	1	35 1/2"
ATL 2	40x63	1	35 1/2"
ATL 3	40x63	2	25 1/4"
ATL 4	40x63	2	24 3/8"
ATL 5	40x63	2	16 7/8"

Log Profile Wall A	
Profile	Profile

40x63	
40x114	
40x57	

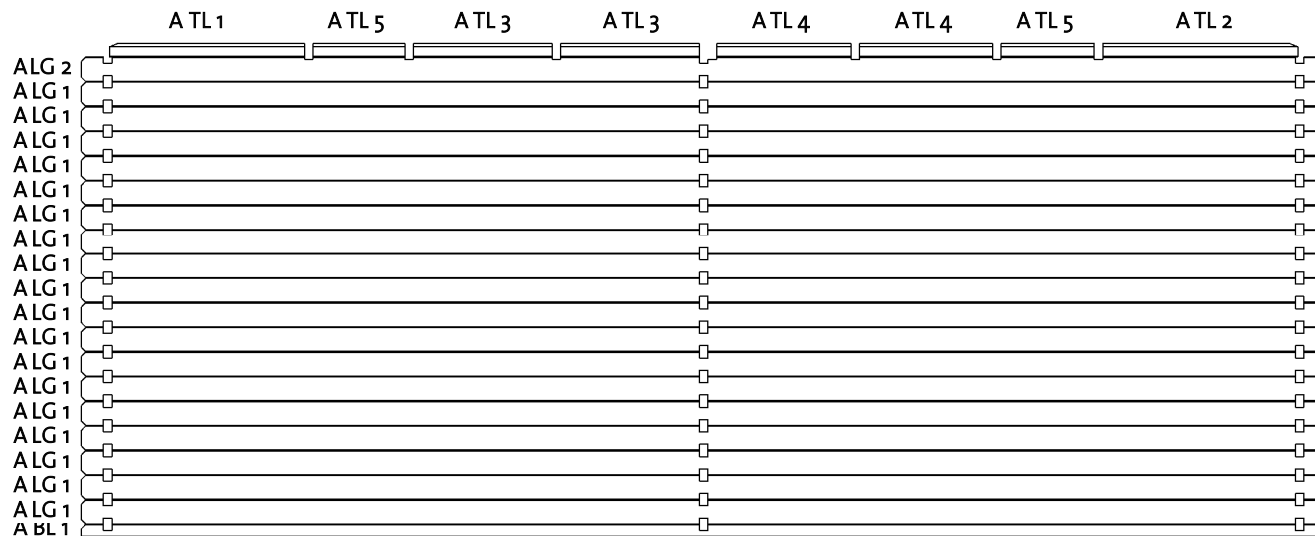

226 3/4"

# Atlantata 1 40 (110 1/4"x218 7/8")

Wall B

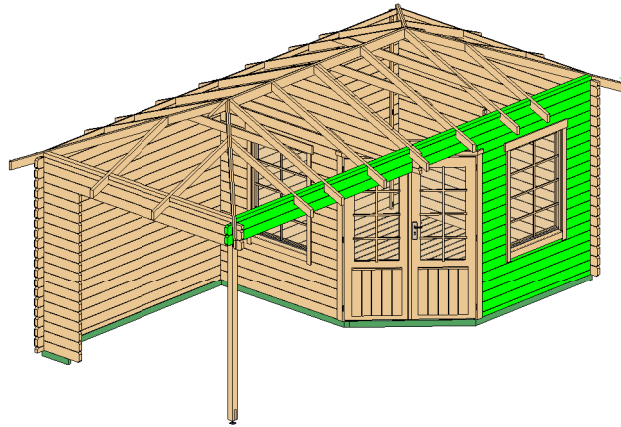

Wall B			
Mark	Profile	Count	Cut Length

BBL 1	40x57	1	72 1/2"
BLG 1	40x114	11	16 3/8"
BLG 2	40x114	11	21 7/8"
BLG 3	40x114	1	76 1/4"
BLG 3/M	40x114	1	76 1/4"
BLG 4	40x114	1	226 3/4"
BLG 5	40x114	1	226 3/4"
BLG 6	40x114	5	72 1/2"
BTL 1	40x63	1	35 1/2"

Wall B			
Mark	Profile	Count	Cut Length

BTL 2	40x63	1	35 1/2"
BTL 3	40x63	2	25 1/4"
BTL 4	40x63	2	24 3/8"
BTL 5	40x63	2	16 7/8"

\*BLG3/M used for mirrored version

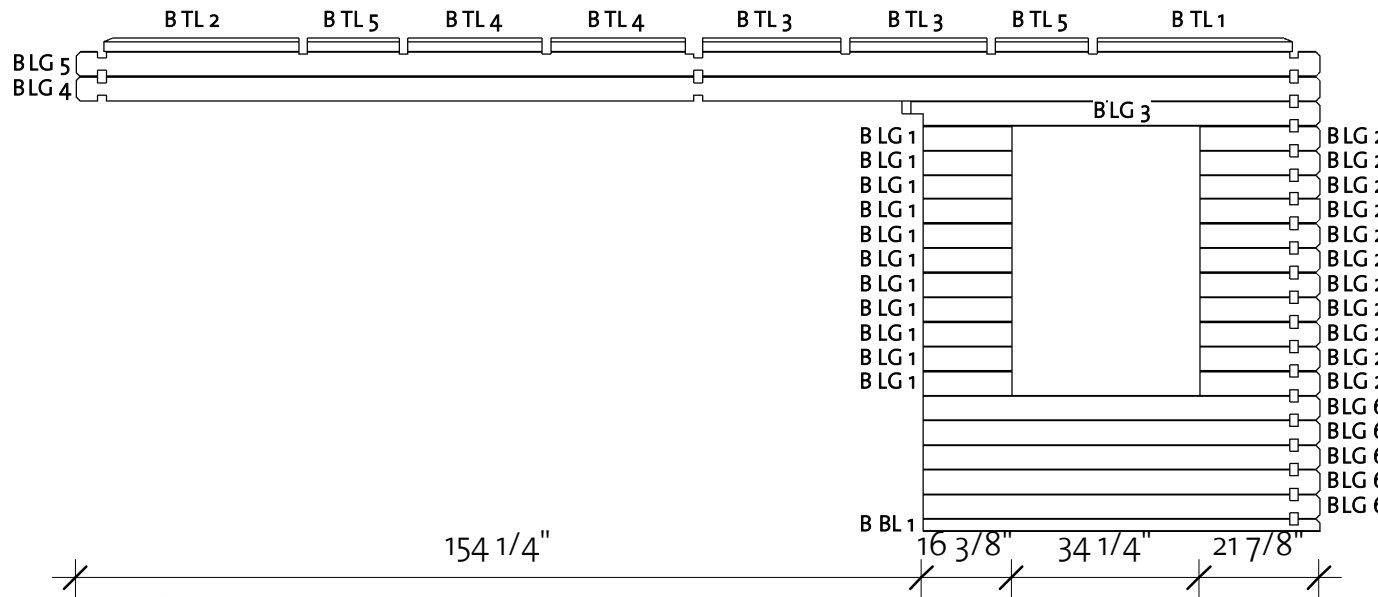

Log Profile Wall B	
Profile	Profile

40x63	
40x114	
40x57	



# Atlantata 1 40 (110 1/4"x218 7/8")

Roof 1

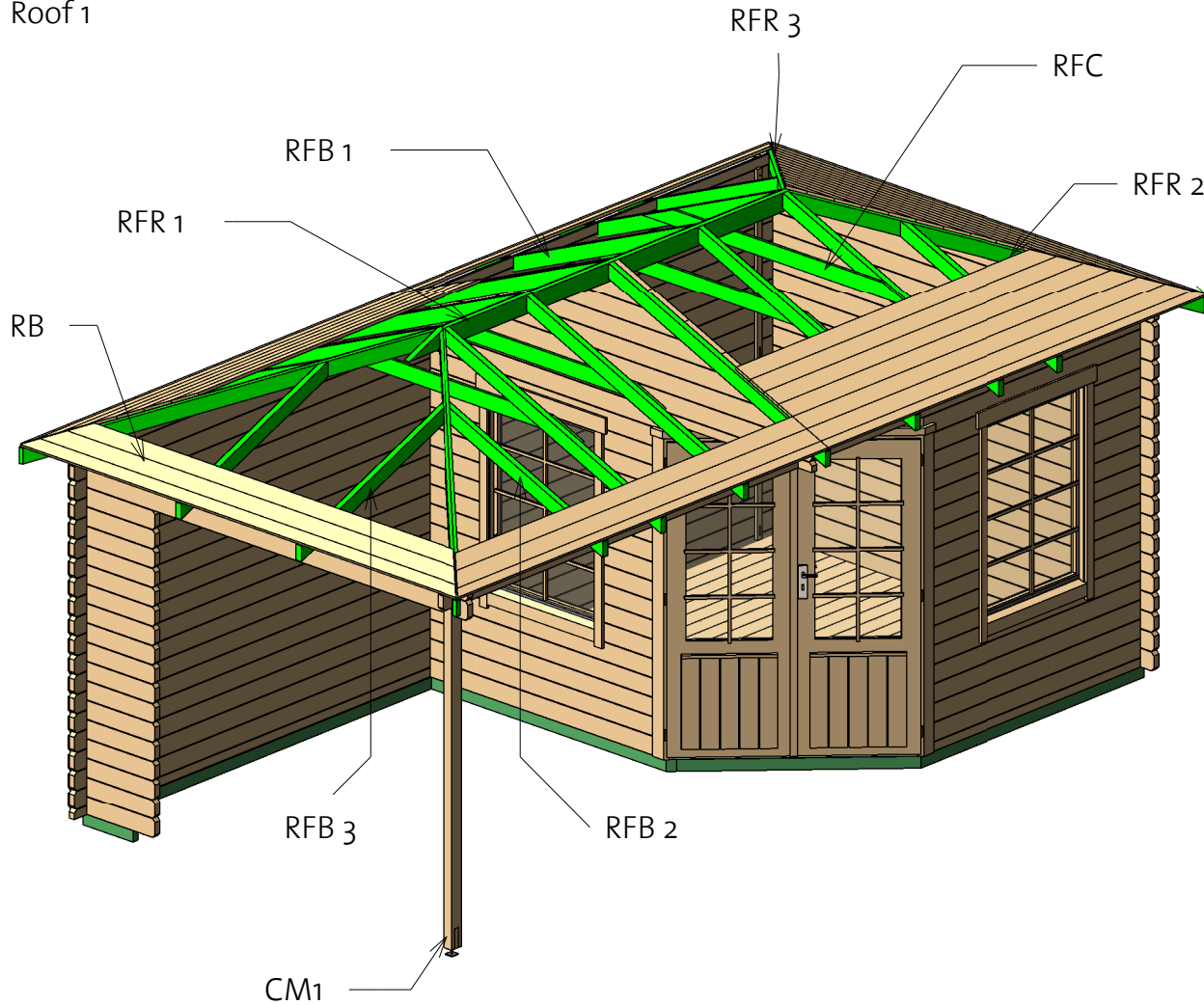

Roof				
Mark	Type	Profile	Count	Length
RFB1	40x85		10	70 1/2"
RFB2	40x85		4	51 7/8"
RFB3	40x85		4	51 7/8"
RFC	18x95		4	79 3/4"
RFR1	40x120		1	131 1/2"
RFR2	40x94		2	95 3/4"
RFR3	40x94		2	95 3/4"

Columns			
Mark	Type	Length	Count
CM1	Post 80x70	79 5/8"	1

# Atlantata 1 40 (110 1/4"x218 7/8")

Roof 2

Roofboards				
Mark	Type	Profile	Count	Length

RB 1	RoofBoard 17x114		2	6 1/2"
RB 2	RoofBoard 17x114		2	14 3/4"
RB 3	RoofBoard 17x114		2	23 1/8"
RB 4	RoofBoard 17x114		2	31 3/8"
RB 5	RoofBoard 17x114		2	39 5/8"
RB 6	RoofBoard 17x114		2	48"
RB 7	RoofBoard 17x114		2	56 1/4"
RB 8	RoofBoard 17x114		2	64 1/2"
RB 9	RoofBoard 17x114		2	72 7/8"
RB 10	RoofBoard 17x114		2	81 1/8"
RB 11	RoofBoard 17x114		2	89 3/8"
RB 12	RoofBoard 17x114		2	97 3/4"
RB 13	RoofBoard 17x114		2	106"
RB 14	RoofBoard 17x114		2	114 3/8"
RB 15	RoofBoard 17x114		2	122 5/8"
RB 16	RoofBoard 17x84		2	128 3/4"
RB 17	RoofBoard 17x114		2	116 7/8"

Roofboards				
Mark	Type	Profile	Count	Length

RB 18	RoofBoard 17x114		2	125 1/8"
RB 19	RoofBoard 17x114		2	133 1/2"
RB 20	RoofBoard 17x114		2	141 3/4"
RB 21	RoofBoard 17x114		2	150 1/8"
RB 22	RoofBoard 17x114		2	158 3/8"
RB 23	RoofBoard 17x114		2	166 5/8"
RB 24	RoofBoard 17x114		2	175"
RB 25	RoofBoard 17x114		2	183 1/4"
RB 26	RoofBoard 17x114		2	97 3/8"
RB 27	RoofBoard 17x114		2	101 1/2"
RB 28	RoofBoard 17x114		2	105 5/8"
RB 29	RoofBoard 17x114		2	109 3/4"
RB 30	RoofBoard 17x114		2	110 3/4"
RB 31	RoofBoard 17x114		2	114 7/8"
RB 32	RoofBoard 17x59		2	120 1/8"
RB 33	RoofBoard 17x59		2	117"
RB 34	RoofBoard 17x114		2	113 7/8"
RB 35	RoofBoard 17x114		2	118 1/8"
RB 36	RoofBoard 17x114		2	106 5/8"
RB 37	RoofBoard 17x114		2	102 1/2"
RB 38	RoofBoard 17x114		2	98 3/8"
RB 39	RoofBoard 17x114		1	94 1/8"
RB 39	RoofBoard 17x114		1	94 1/4"

# Atlantata 1 40 (110 1/4"x218 7/8")

Roof 3

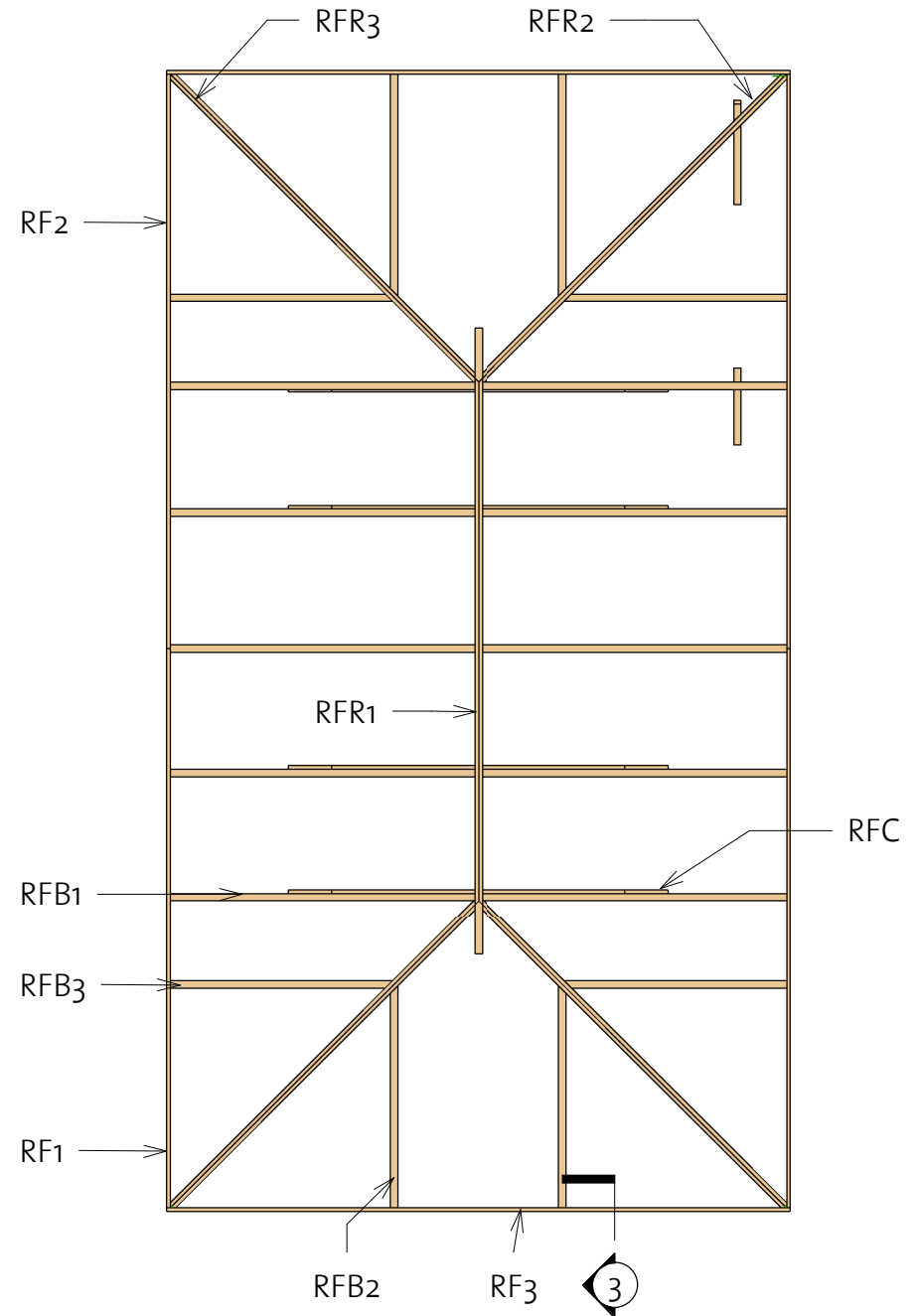
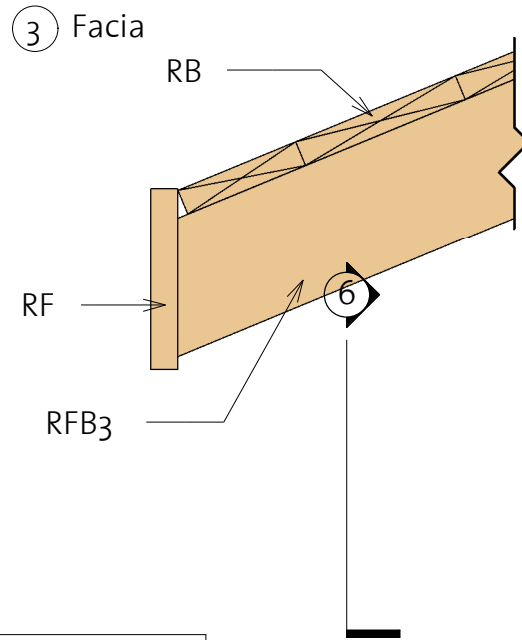
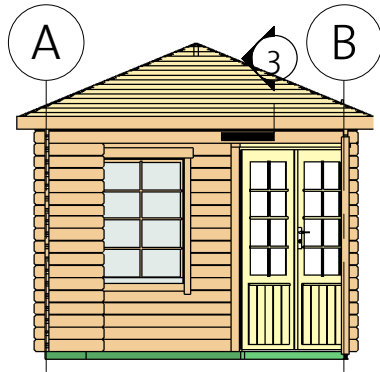

Fascia Schedule

Mark	Type	Profile	Count	Length
------	------	---------	-------	--------

RF1	Roof Fascia 18x120		2	117 3/8"
RF2	Roof Fascia 18x120		2	120 1/2"
RF3	Roof Fascia 18x120		2	130 5/8"

4200015\_220906

# Atlanata 1 40 (110 1/4"x218 7/8")

Extras

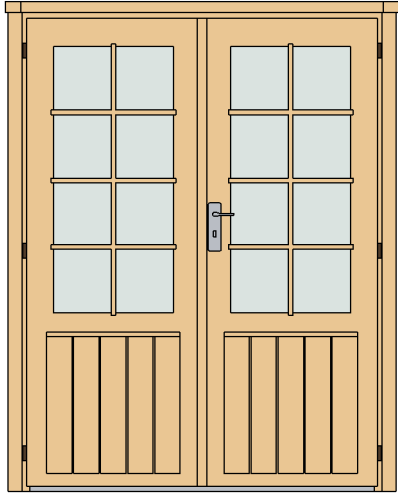

CDD7R	Classic double door 7 right	56 1/8"	74 3/4"	1
-------	-----------------------------	---------	---------	---

DCB8	Door crossbar 8	--	--	2
------	-----------------	----	----	---

Window Schedule				
Model	Type	Width	Height	Count

CW2L	Classic window 2 left	34"	47 5/8"	1
CW2R	Classic window 2 right	34"	47 5/8"	1

WCB8	Windows Crossbar 8	--	--	2
------	--------------------	----	----	---

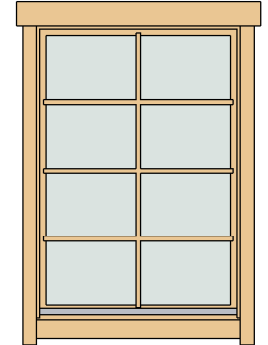

Fasteners/Extras		
Name	Type	Count

Hitblock	300-400 mm	
Adjustable post foot		1
Bolts	M8 x 70	18
Nails	1,4 x 40	30
Screws	5,0 x 70	60
Screws	6,0 x 140	100
Screws	4,0 x 40	780

Type	Count	Lenght
Windboard 18x40	6	86 5/8"

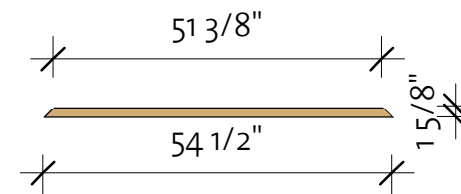

Ceiling detail 40x120	CD	1
Ceiling triangle	CT	1

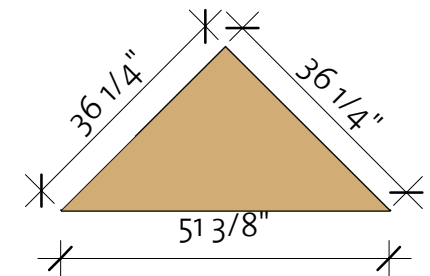

# Atlanta 1 40 (110 1/4"x218 7/8")

## List of all items 1

### Impregnated foundation beams

Mark	Type	Profile	Count	Length
IFB1	IFB 40x70		6	108 1/4"
IFB2	IFB 40x70		1	87 5/8"
IFB3	IFB 40x70		1	72 5/8"
IFB4	IFB 40x70		1	71 1/8"
IFB5	IFB 40x70		2	54 1/4"
IFB6	IFB 40x70		1	107 1/8"
IFB7	IFB 40x70		1	14 3/4"

BB	BB 20x40		4	110 1/4"
----	-------------	---	---	----------



### Columns

Mark	Type	Length	Count
CM1	Post 80x70	79 5/8"	1

### Floor Schedule

Mark	Type	Profile	Count	Length
FB 1	FB 17x114		1	72 3/8"
FB 2	FB 17x114		1	76 3/4"
FB 3	FB 17x114		1	81 1/4"
FB 4	FB 17x114		1	85 3/4"
FB 5	FB 17x114		1	90 1/4"
FB 6	FB 17x114		1	94 3/4"
FB 7	FB 17x114		1	99 1/4"
FB 8	FB 17x114		1	103 3/4"
FB 9	FB 17x114		16	107"
FB 10	FB 17x114		1	107"

### Roof

Mark	Type	Profile	Count	Length
RFB1	40x85		10	70 1/2"
RFB2	40x85		4	51 7/8"
RFB3	40x85		4	51 7/8"
RFC	18x95		4	79 3/4"
RFR1	40x120		1	131 1/2"
RFR2	40x94		2	95 3/4"
RFR3	40x94		2	95 3/4"

# Atlanata 1 40 (110 1/4"x218 7/8")

## List of all items 2

### Fascia Schedule

Mark	Type	Profile	Count	Length
RF1	Roof Fascia 18x120		2	117 3/8"
RF2	Roof Fascia 18x120		2	120 1/2"
RF3	Roof Fascia 18x120		2	130 5/8"

### Wall 1

Mark	Profile	Count	Cut Length
1LG 1	40x114	17	25 5/8"
1LG 2	40x114	1	118 1/8"
1LG 3	40x114	1	118 1/8"
1TL 1	40x63	1	35 1/2"
1TL 2	40x63	1	33 7/8"
1TL 3	40x63	1	35 1/2"
1TL 4	40x57 TL	1	118 1/8"

### Roofboards

Mark	Type	Profile	Count	Length
RB 1	RoofBoard 17x114		2	6 1/2"
RB 2	RoofBoard 17x114		2	14 3/4"
RB 3	RoofBoard 17x114		2	23 1/8"
RB 4	RoofBoard 17x114		2	31 3/8"
RB 5	RoofBoard 17x114		2	39 5/8"
RB 6	RoofBoard 17x114		2	48"
RB 7	RoofBoard 17x114		2	56 1/4"
RB 8	RoofBoard 17x114		2	64 1/2"
RB 9	RoofBoard 17x114		2	72 7/8"
RB 10	RoofBoard 17x114		2	81 1/8"
RB 11	RoofBoard 17x114		2	89 3/8"
RB 12	RoofBoard 17x114		2	97 3/4"
RB 13	RoofBoard 17x114		2	106"
RB 14	RoofBoard 17x114		2	114 3/8"
RB 15	RoofBoard 17x114		2	122 5/8"
RB 16	RoofBoard 17x84		2	128 3/4"
RB 17	RoofBoard 17x114		2	116 7/8"
RB 18	RoofBoard 17x114		2	125 1/8"
RB 19	RoofBoard 17x114		2	133 1/2"
RB 20	RoofBoard 17x114		2	141 3/4"
RB 21	RoofBoard 17x114		2	150 1/8"
RB 22	RoofBoard 17x114		2	158 3/8"
RB 23	RoofBoard 17x114		2	166 5/8"
RB 24	RoofBoard 17x114		2	175"
RB 25	RoofBoard 17x114		2	183 1/4"
RB 26	RoofBoard 17x114		2	97 3/8"
RB 27	RoofBoard 17x114		2	101 1/2"
RB 28	RoofBoard 17x114		2	105 5/8"
RB 29	RoofBoard 17x114		2	109 3/4"
RB 30	RoofBoard 17x114		2	110 3/4"
RB 31	RoofBoard 17x114		2	114 7/8"
RB 32	RoofBoard 17x59		2	120 1/8"
RB 33	RoofBoard 17x59		2	117"
RB 34	RoofBoard 17x114		2	113 7/8"
RB 35	RoofBoard 17x114		2	118 1/8"
RB 36	RoofBoard 17x114		2	106 5/8"
RB 37	RoofBoard 17x114		2	102 1/2"
RB 38	RoofBoard 17x114		2	98 3/8"
RB 39	RoofBoard 17x114		1	94 1/8"
RB 39	RoofBoard 17x114		1	94 1/4"

# Atlantata 1 40 (110 1/4"x218 7/8")

## List of all items 3

Wall 2			
Mark	Profile	Count	Cut Length

2LG 1 *	40X114	1	21 1/2"
2LG 2	40X114	10	21 7/8"
2LG 3	40X114	10	16 3/8"
2LG 4 *	40X114	1	43 1/4"
2LG 5 *	40X114	1	64 7/8"
2LG 6 *	40X114	1	86 1/2"
2LG 7 *	40X114	1	108 1/4"
2LG 8 *	40X114	1	118 1/8"
2LG 9	40X114	1	118 1/8"
2LG 10	40X114	5	72 1/2"
2LG 11	40X114	1	118 1/8"
2LG 11/M	40X114	1	118 1/8"
2LG 12	40X114	1	72 1/2"
2LG 13	40X114	1	72 1/2"

\* Gable - delivered premounted

Wall 3			
Mark	Profile	Count	Cut Length

3LG 1	40X114	19	118 1/8"
3TL 1	40X63	1	35 1/2"
3TL 2	40X63	1	33 7/8"
3TL 3	40X63	1	35 1/2"
3TL 4	40X57 TL	1	118 1/8"

Wall A			
Mark	Profile	Count	Cut Length

ABL 1	40X57	1	226 3/4"
ALG 1	40X114	18	226 3/4"
ALG 2	40X114	1	226 3/4"
ATL 1	40X63	1	35 1/2"
ATL 2	40X63	1	35 1/2"
ATL 3	40X63	2	25 1/4"
ATL 4	40X63	2	24 3/8"
ATL 5	40X63	2	16 7/8"

Wall B			
Mark	Profile	Count	Cut Length

BBL 1	40X57	1	72 1/2"
BLG 1	40X114	11	16 3/8"
BLG 2	40X114	11	21 7/8"
BLG 3	40X114	1	76 1/4"
BLG 3/M	40X114	1	76 1/4"
BLG 4	40X114	1	226 3/4"
BLG 5	40X114	1	226 3/4"
BLG 6	40X114	5	72 1/2"
BTL 1	40X63	1	35 1/2"



Wall B			
Mark	Profile	Count	Cut Length

BTL 2	40X63	1	35 1/2"
BTL 3	40X63	2	25 1/4"
BTL 4	40X63	2	24 3/8"
BTL 5	40X63	2	16 7/8"

# Atlanata 1 40 (110 1/4"x218 7/8")

List of all items 4

Log Profiles	
Profile	Profile

40x57	
40x57 TL	
40x63	
40x114	