

Luna 3 1 9/16" (217 5/16x196 7/8")

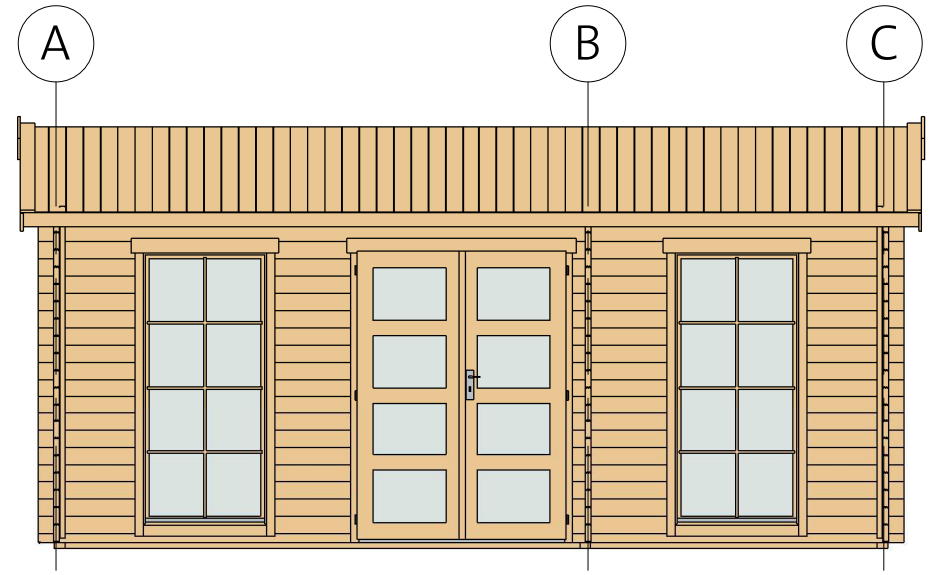

Luna 3 1 9/16" (217 5/16x196 7/8")

Foundation

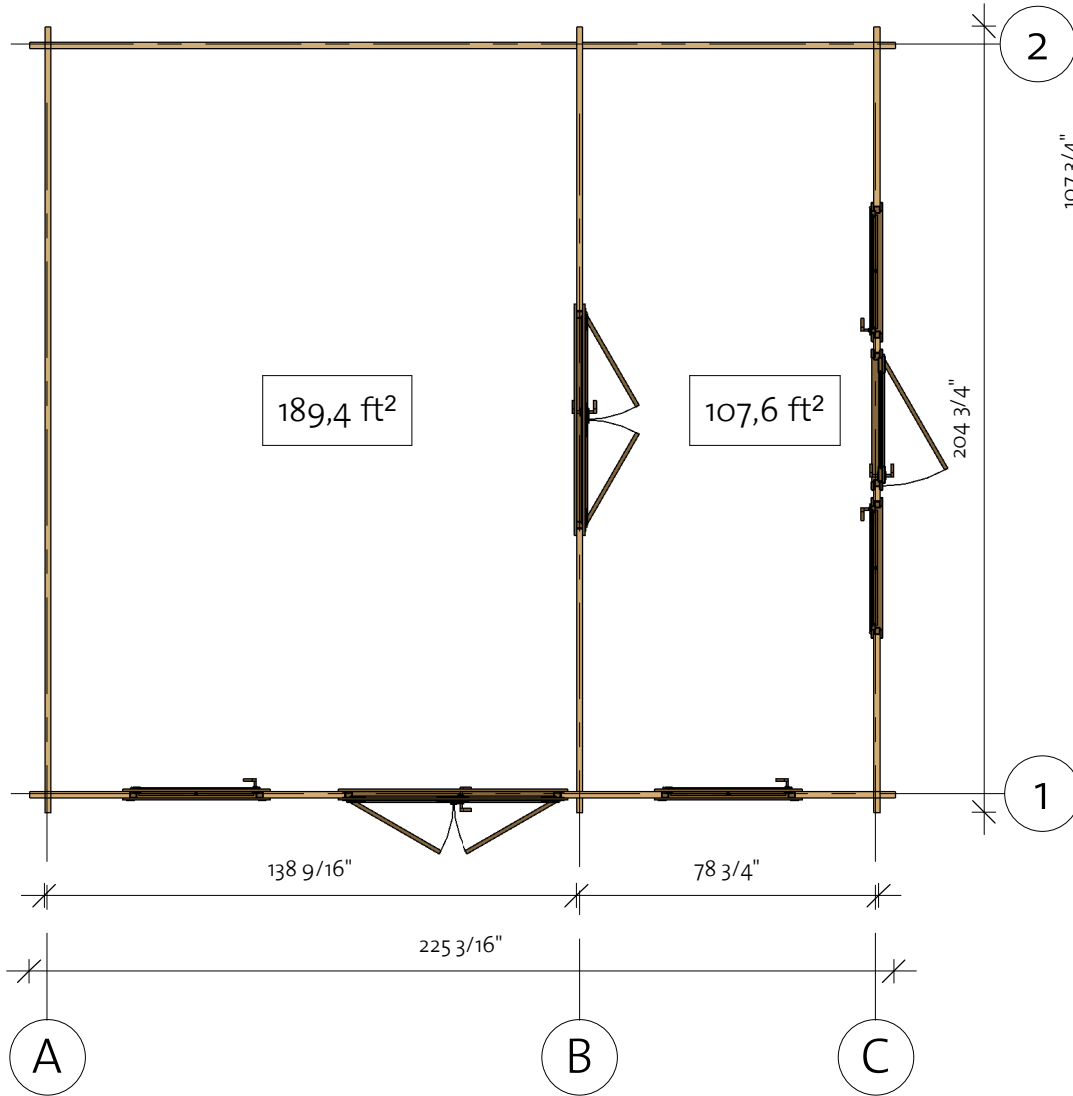
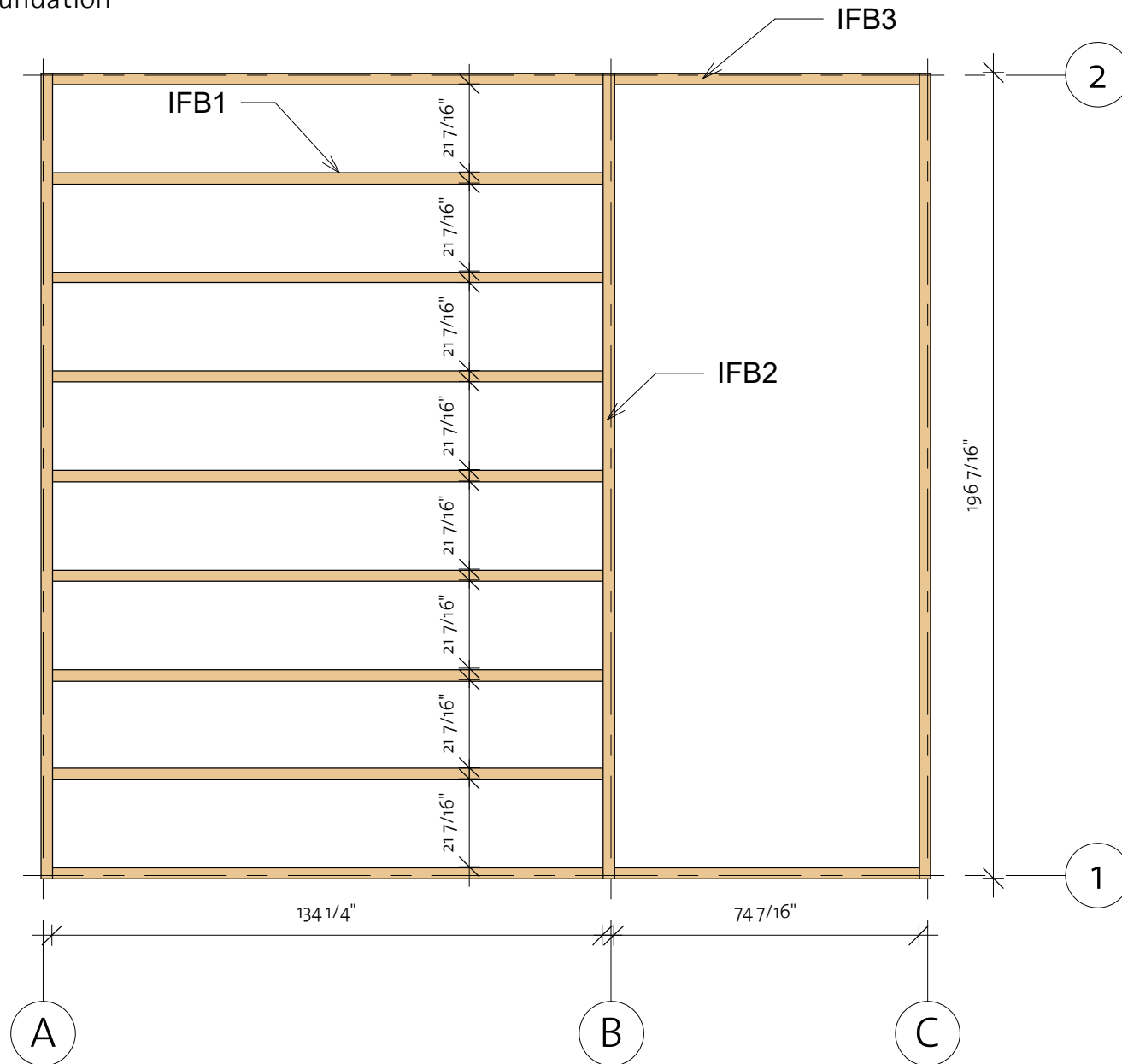

Impregnated foundation beams				
Mark	Type	Profile	Count	Length

IFB1	IFB 70x40		9	134 1/4"
IFB2	IFB 70x40		3	196 7/16"
IFB3	IFB 70x40		2	74 7/16"



Luna 3 1 9/16" (217 5/16x196 7/8")

Floor Plan

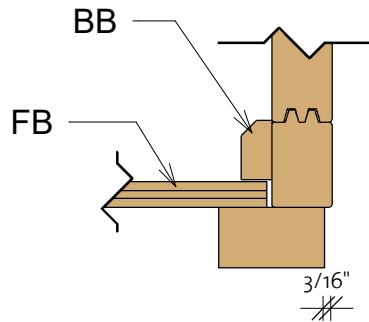
① Baseboard



Floor Schedule

Mark	Type	Profile	Count	Length
FB	FB 17x114		32	193 7/16"
BB1	BB 20x40		2	140 3/16"
BB2	BB 20x40		2	196 7/8"

201117

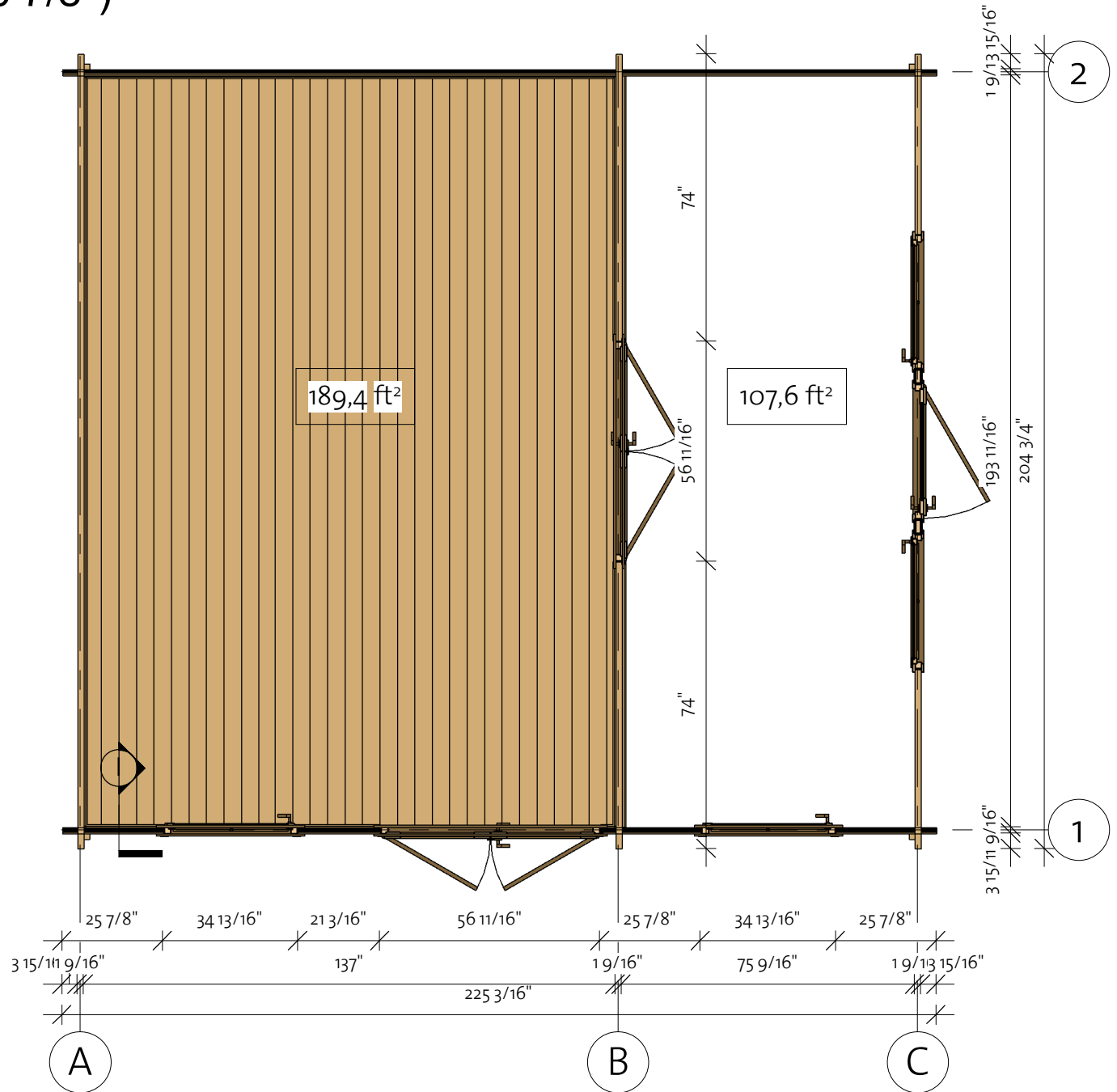

Luna 3 1 9/16" (217 5/16x196 7/8")

Wall 1

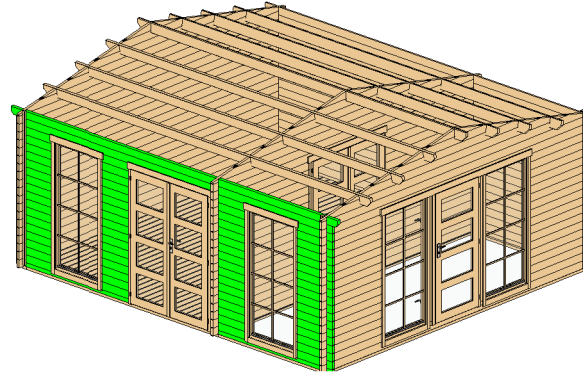

Wall 1			
Mark	Profile	Count	Cut Length

1BL-1	4OX57	1	86 5/8"
1BL-2	4OX57	1	81 7/8"
1LG-1	4OX114	17	21 3/16"
1LG-2	4OX114	51	25 7/8"
1LG-3	4OX114	1	225 3/16"
1TL-1	4OX114	1	233 1/16"

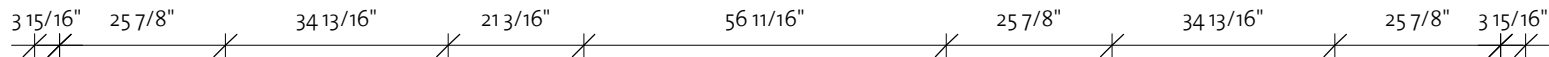
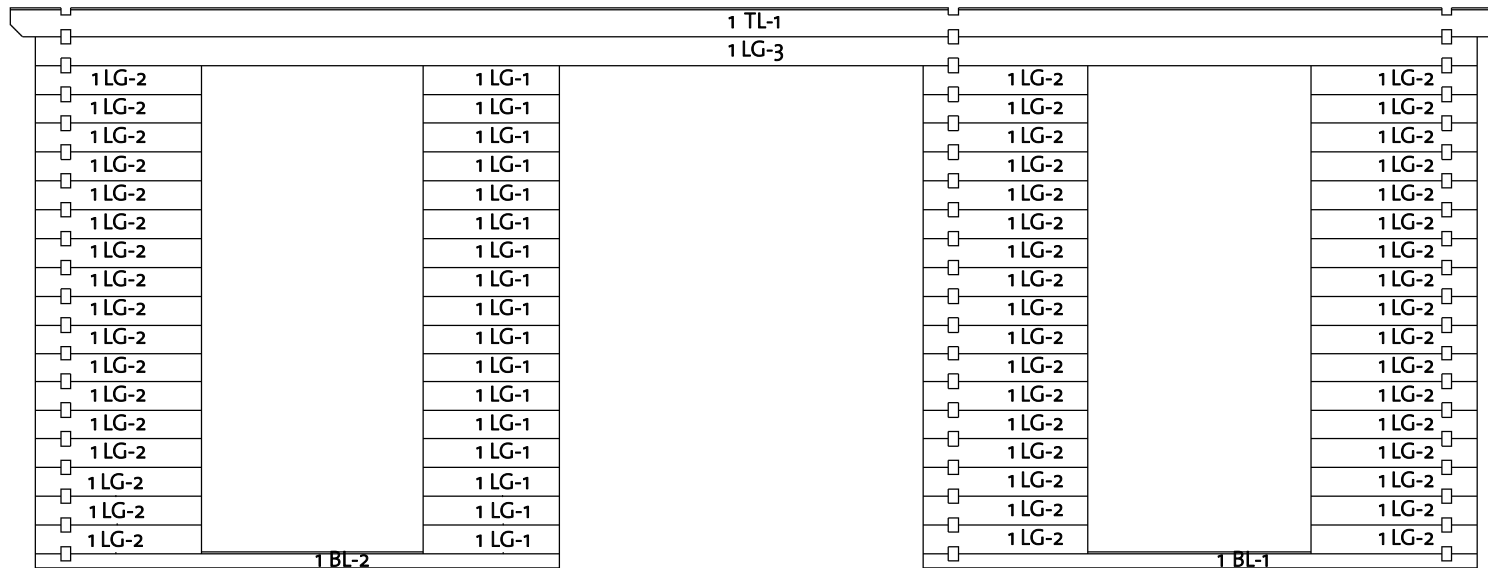

Log Profile Wall 1	
Profile	Profile

4OX57	
4OX114	
4OX114	

Luna 3 1 9/16" (217 5/16x196 7/8")

Wall 2

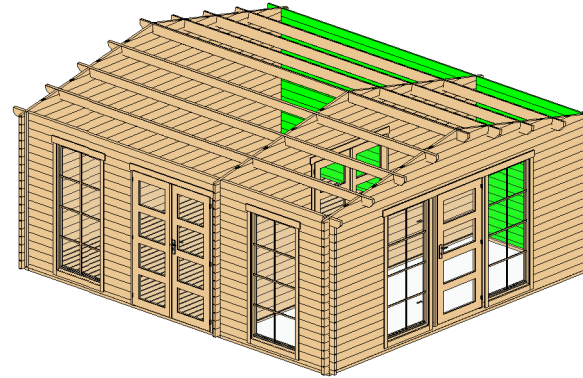

Wall 2			
Mark	Profile	Count	Cut Length
2BL-1	40X57	1	225 3/16"
2LG-1	40X114	18	225 3/16"
2TL-1	40X114	1	233 1/16"

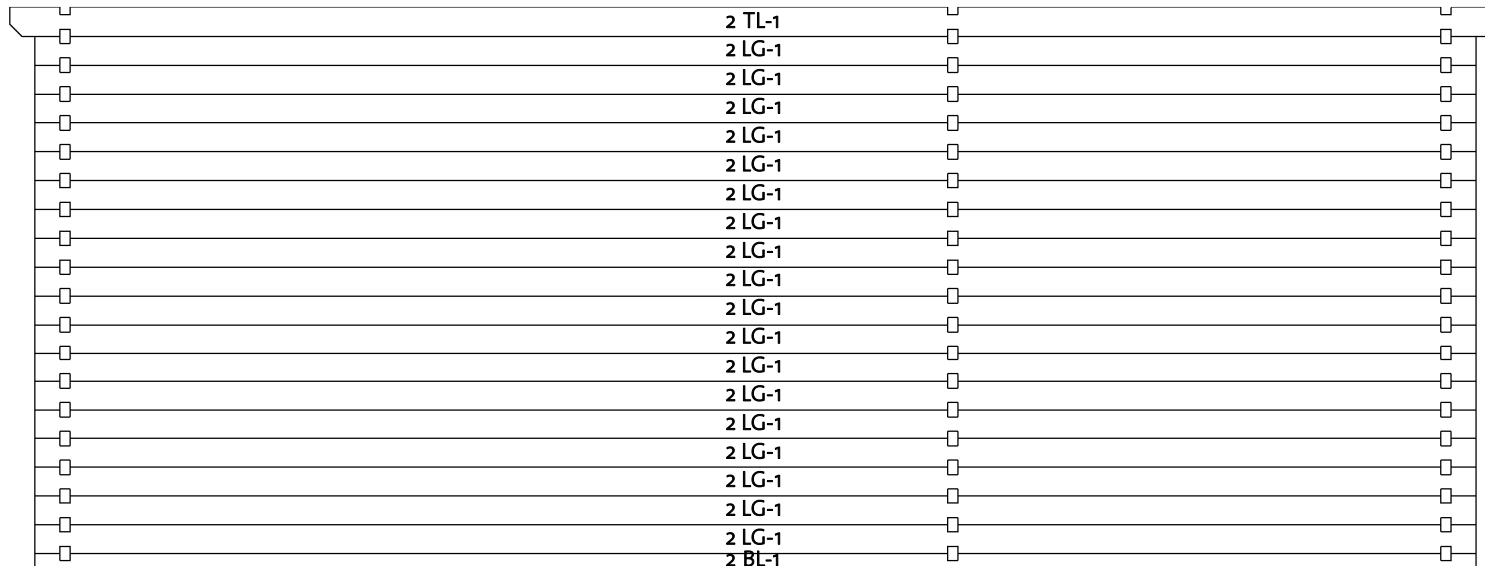

3 15/16"
X X

225 3/16"

3 15/16"
X X

Log Profile Wall 2	
Profile	Profile

40X57	
40X114	
40X114	

Luna 3 1 9/16" (217 5/16x196 7/8")

Wall A

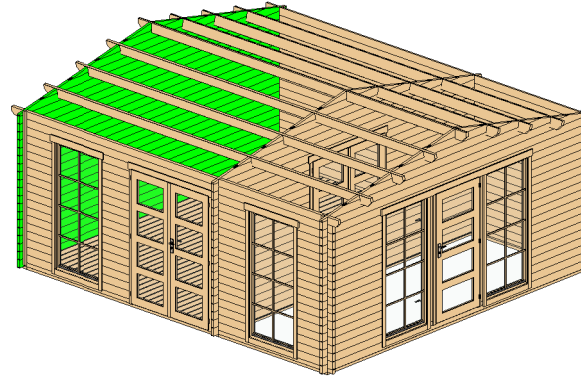

Wall A			
Mark	Profile	Count	Cut Length

ALG-1*	40x114	1	43 1/8"
ALG-2*	40x114	1	86 1/8"
ALG-3*	40x114	1	129 3/16"
ALG-4*	40x114	1	172 3/16"
ALG-5*	40x114	1	204 3/4"
ALG-6	40x114	19	204 3/4"

*Gable-delivered premounted

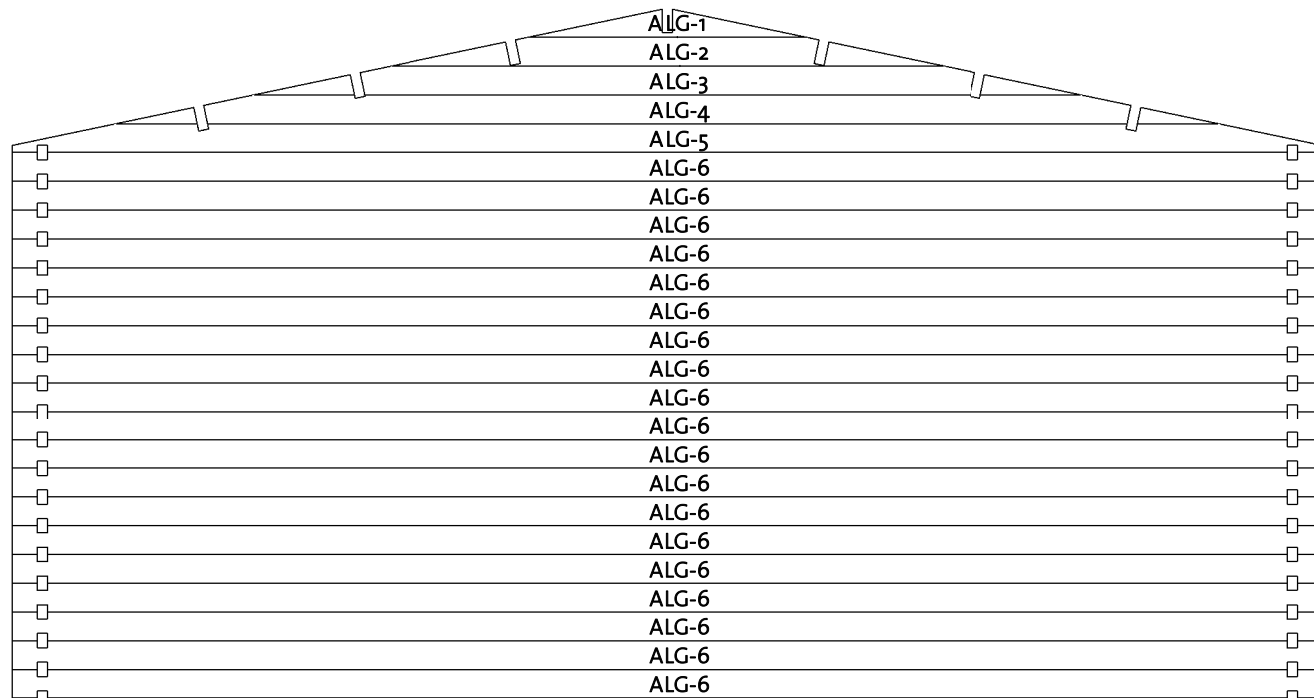

204 3/4"

Log Profile Wall A	
Profile	Profile

40x114	
--------	--

Luna 3 1 9/16" (217 5/16x196 7/8")

Wall B

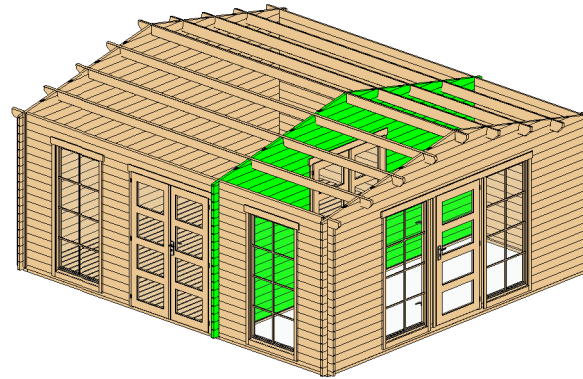

Wall B			
Mark	Profile	Count	Cut Length
BLG-1*	40X114	1	43 1/8"
BLG-2*	40X114	1	86 1/8"
BLG-3*	40X114	1	129 3/16"
BLG-4*	40X114	1	172 3/16"
BLG-5*	40X114	1	204 3/4"
BLG-6	40X114	1	204 3/4"
BLG-7	40X114	1	204 3/4"
BLG-8	40X114	34	74"

*Gable-delivered premounted

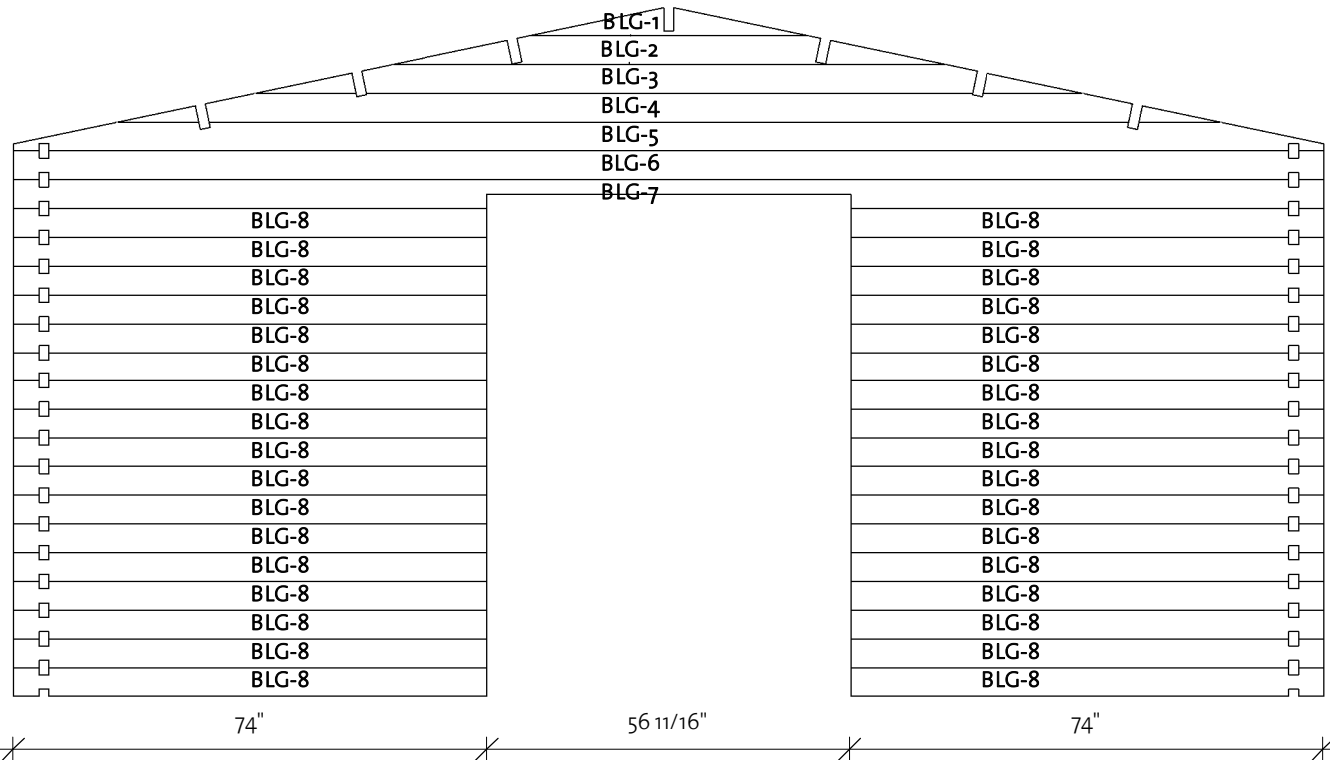

Log Profile Wall B	
Profile	Profile
40X114	

Luna 3 1 9/16" (217 5/16x196 7/8")

Wall C

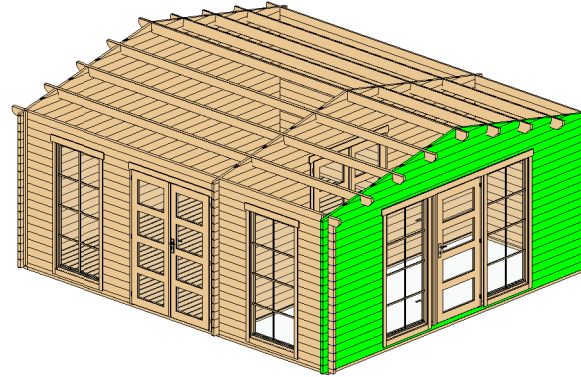

Wall C			
Mark	Profile	Count	Cut Length

CLG-1*	40x114	1	43 1/8"
CLG-2*	40x114	1	86 1/8"
CLG-3*	40x114	1	129 3/16"
CLG-4*	40x114	1	172 3/16"
CLG-5*	40x114	1	204 3/4"
CLG-6	40x114	1	204 3/4"
CLG-7	40x114	32	46 3/8"
CLG-8	40x114	1	204 3/4"
CLG-9	40x114	1	204 3/4"

*Gable-delivered premounted

Columns			
Mark	Profile	Count	Length

CM1	Post 40x94	2	74 7/16"
-----	------------	---	----------

Log Profile Wall C	
Profile	Profile

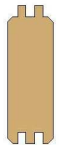

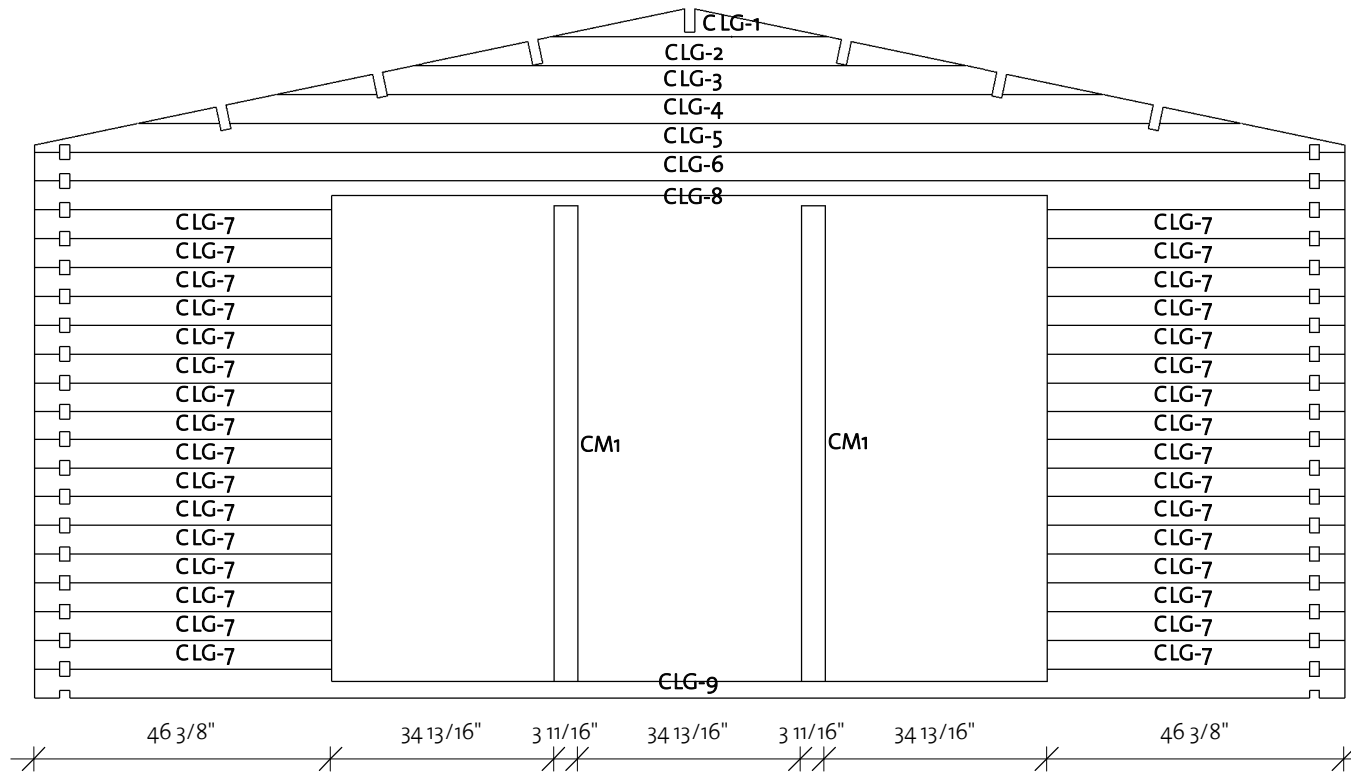
40X114	
--------	---

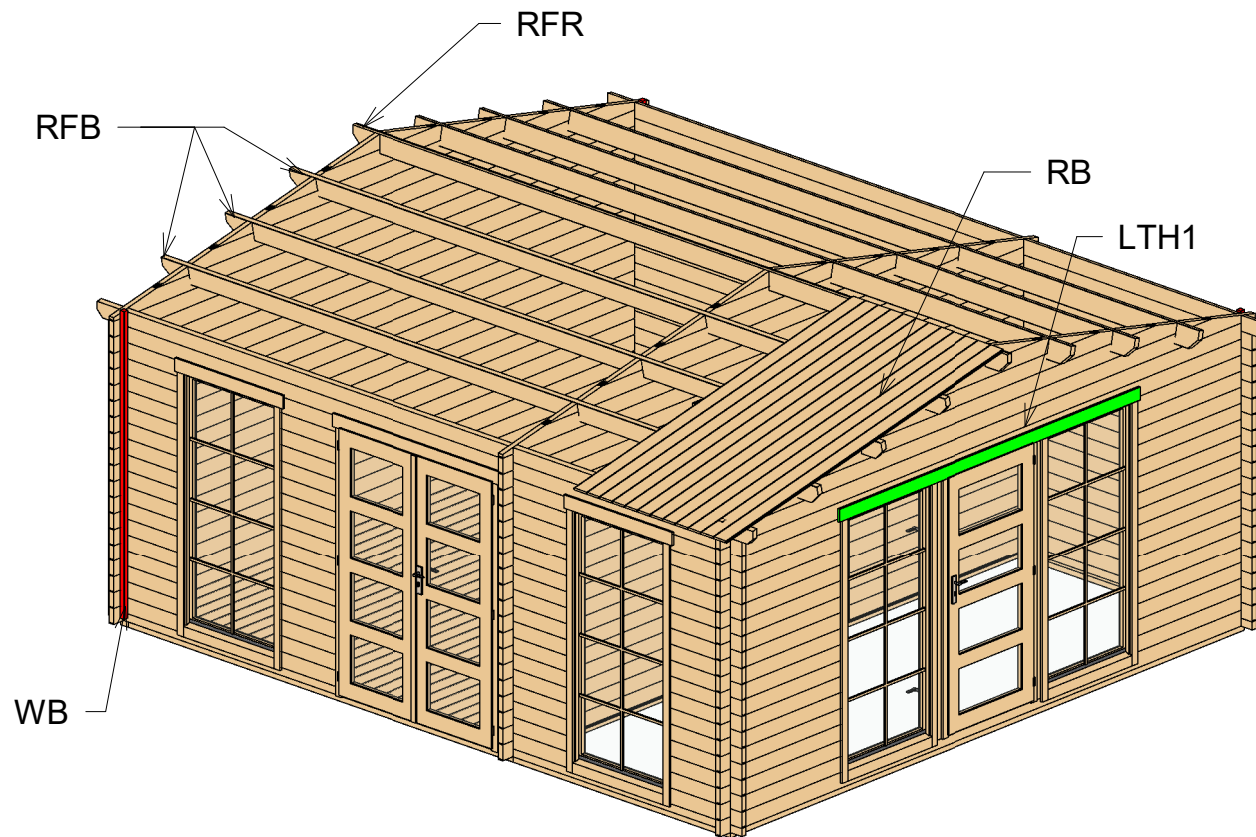

Luna 3 1 9/16" (217 5/16x196 7/8")

Roof 1



Roof				
Mark	Type	Profile	Count	Length
RFR	Ridge 40x143		1	233 1/16"
RFB	Beam 40x143		6	233 1/16"
RB	17x114		106	108 7/16"

Lath list				
Mark	Type	Profile	Count	Length
LTH1	18x95		2	115 3/8"

Luna 3 1 9/16" (217 5/16x196 7/8")

Roof 2

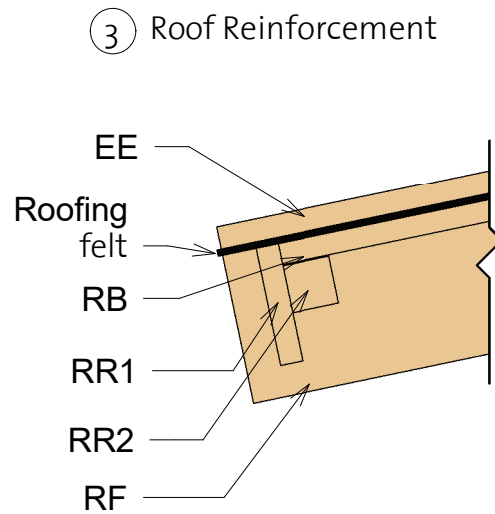
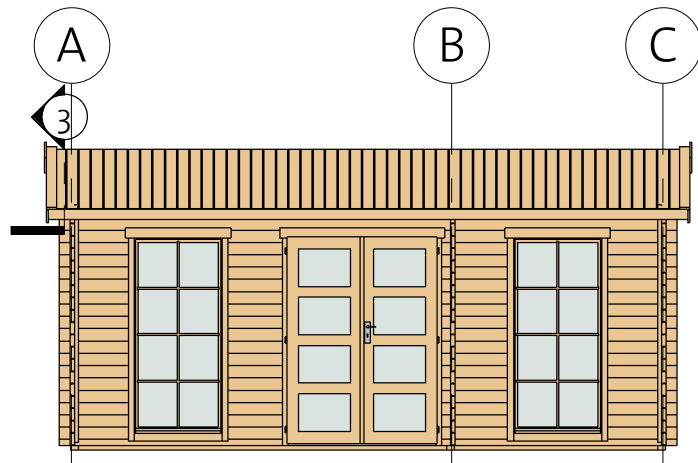
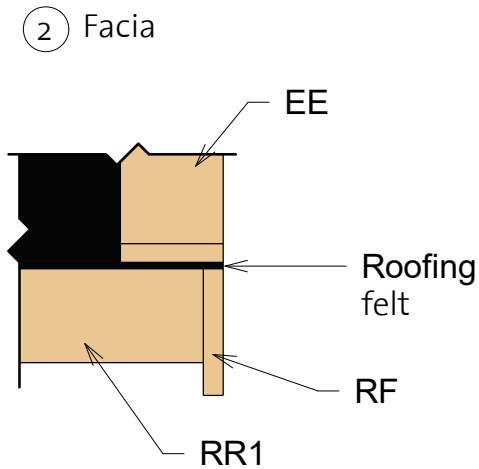
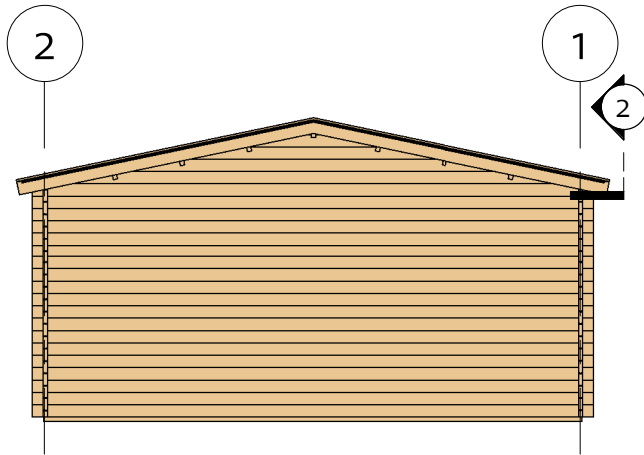

Fascia Schedule				
Mark	Type	Profile	Count	Length
EE	Eave Edging 18x95		4	110 3/8"
RF	Roof Fascia 18x120		4	110 3/8"
RR1	Roof reinforcement 18x95		2	233 1/16"
RR2	Roof reinforcement 38x38		2	233 1/16"

Luna 3 1 9/16" (217 5/16x196 7/8")

Extras

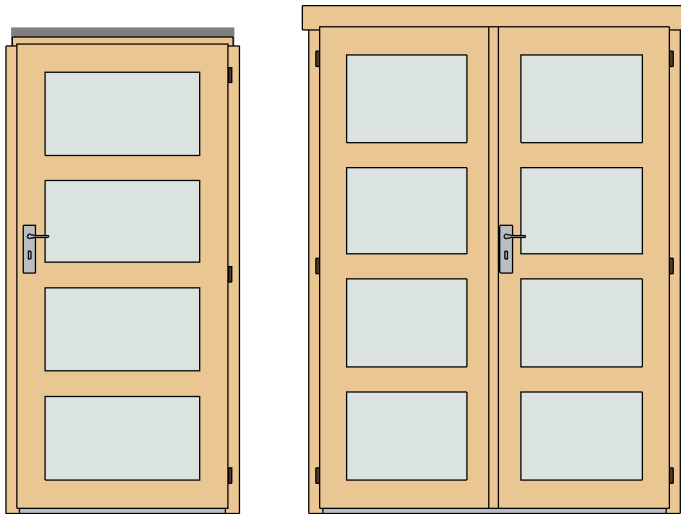

Door Schedule				
Mark	Type	Width	Height	Count
CD12R	Classic door 12, four glass right	34 7/16"	74 7/16"	1
CDD2R	Classic double door 2, four glass right	56 1/8"	76 15/16"	2

Fasteners & Extras		
Name	Type	Count

Hitblock	11 13/16"-15 3/4"	
Screws	3/16" x 2 3/4"	20
Bolts	M5/16" x 3 9/16"	20
Nails	1/16" x 1 9/16"	45
Screws	1/4" x 5 1/2"	80
Screws	3/16" x 1 9/16"	130
Screws	3/16" x 2"	920

Family	Count
Romb	2



Windboard		
Type	Count	Length
Windboard 38x38	4	86 5/8"

Luna 3 1 9/16" (217 5/16x196 7/8")

Extra 2

CW4L x 1

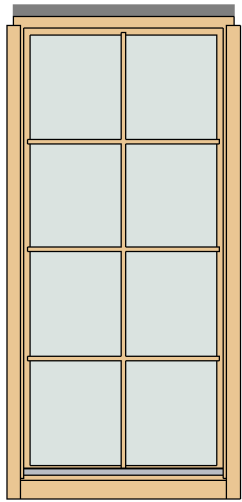

CW4R x 2

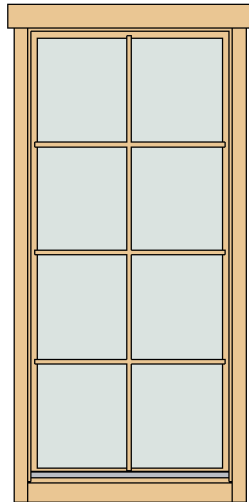

CW4R x 1

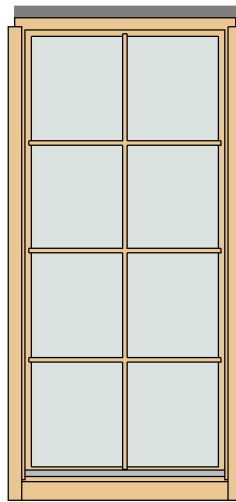

Window Schedule

Mark	Type	Width	Height	Count
CW4L	Classic window 4, left	34 7/16"	74 7/16"	1
CW4R	Classic window 4, right	34 7/16"	74 7/16"	2
CW4R	Classic window 4, right	34 7/16"	74 7/16"	1
WCB8-2	Windows Crossbar 8-2	--	--	5



Luna 3 1 9/16" (217 5/16x196 7/8")

List of all items 1



Impregnated foundation beams

Mark	Type	Profile	Count	Length
IFB1	IFB 70x40		9	134 1/4"
IFB2	IFB 70x40		3	196 7/16"
IFB3	IFB 70x40		2	74 7/16"





Floor Schedule

Mark	Type	Profile	Count	Length
FB	FB 17x114		32	193 7/16"
BB1	BB 20x40		2	140 3/16"
BB2	BB 20x40		2	196 7/8"

Roof

Mark	Type	Profile	Count	Length
RFR	Ridge 40x143		1	233 1/16"
RFB	Beam 40x143		6	233 1/16"
RB	17x114		106	108 7/16"

Fascia Schedule

Mark	Type	Profile	Count	Length
EE	Eave Edging 18x95		4	110 3/8"
RF	Roof Fascia 18x120		4	110 3/8"
RR1	Roof reinforcement 18x95		2	233 1/16"
RR2	Roof reinforcement 38x38		2	233 1/16"

Luna 3 1 9/16" (217 5/16x196 7/8")

List of all items 2

Wall 1			
Mark	Profile	Count	Cut Length

1BL-1	40x57	1	86 5/8"
1BL-2	40x57	1	81 7/8"
1LG-1	40x114	17	21 3/16"
1LG-2	40x114	51	25 7/8"
1LG-3	40x114	1	225 3/16"
1TL-1	40x114	1	233 1/16"

Wall 2			
Mark	Profile	Count	Cut Length

2BL-1	40x57	1	225 3/16"
2LG-1	40x114	18	225 3/16"
2TL-1	40x114	1	233 1/16"



Lath list				
Mark	Type	Profile	Count	Length

LTH1	18x95		2	115 3/8"
------	-------	--	---	----------

Columns			
Mark	Profile	Count	Length

CM1	Post 40x94	2	74 7/16"
-----	------------	---	----------

Log Profiles	
Profile	Profile

40x57	
40x114	

Log Profiles	
Profile	Profile

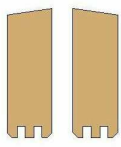
40x114	
--------	---

Luna 3 1 9/16" (217 5/16x196 7/8")

List of all items 3

Wall A			
Mark	Profile	Count	Cut Length

ALG-1*	40X114	1	43 1/8"
ALG-2*	40X114	1	86 1/8"
ALG-3*	40X114	1	129 3/16"
ALG-4*	40X114	1	172 3/16"
ALG-5*	40X114	1	204 3/4"
ALG-6	40X114	19	204 3/4"

Wall C			
Mark	Profile	Count	Cut Length

CLG-1*	40X114	1	43 1/8"
CLG-2*	40X114	1	86 1/8"
CLG-3*	40X114	1	129 3/16"
CLG-4*	40X114	1	172 3/16"
CLG-5*	40X114	1	204 3/4"
CLG-6	40X114	1	204 3/4"
CLG-7	40X114	32	46 3/8"
CLG-8	40X114	1	204 3/4"
CLG-9	40X114	1	204 3/4"

Log Profiles2	
Profile	Profile

40X114	
--------	---

Wall B			
Mark	Profile	Count	Cut Length

BLG-1*	40X114	1	43 1/8"
BLG-2*	40X114	1	86 1/8"
BLG-3*	40X114	1	129 3/16"
BLG-4*	40X114	1	172 3/16"
BLG-5*	40X114	1	204 3/4"
BLG-6	40X114	1	204 3/4"
BLG-7	40X114	1	204 3/4"
BLG-8	40X114	34	74"

*Gable-delivered premounted