

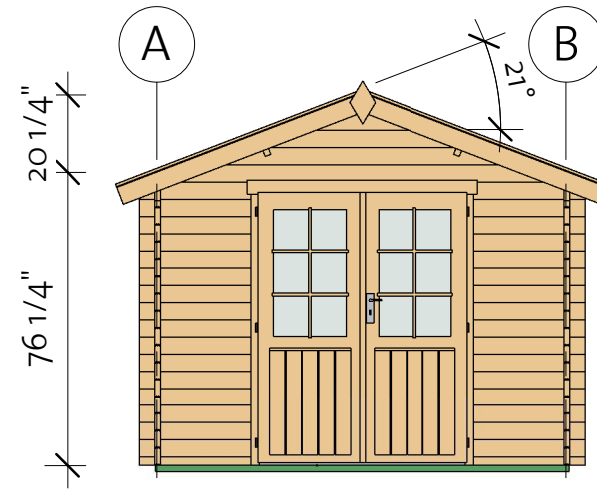

Scion 40 (108 1/4" x 149 5/8")

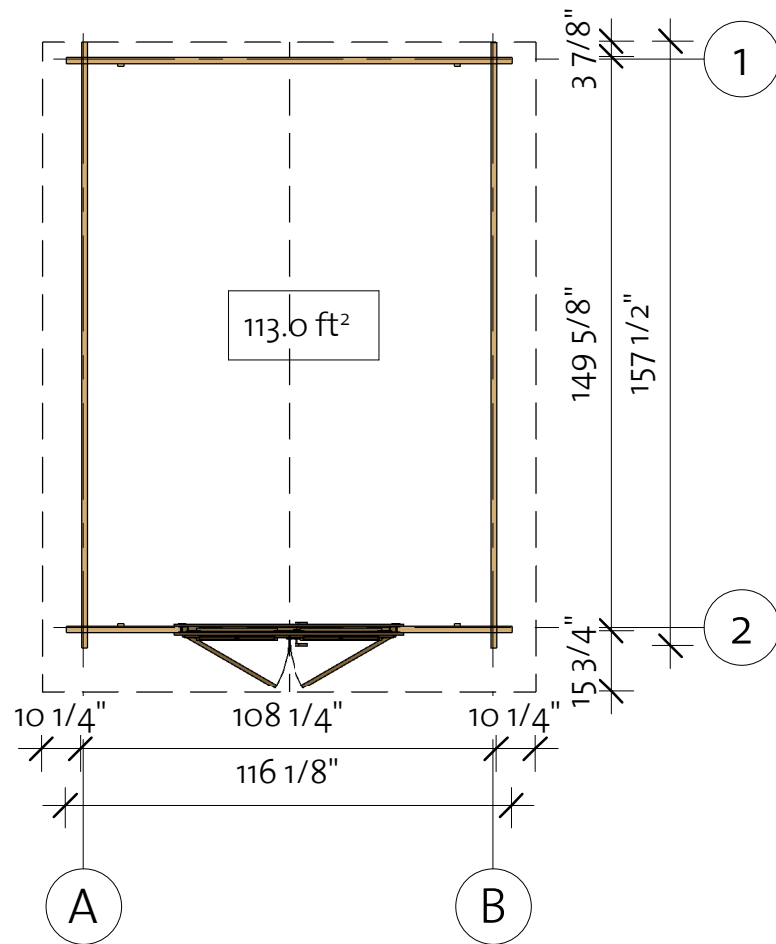

Scion 40 (108 1/4" x 149 5/8")

Foundation

Impregnated foundation beams				
Mark	Type	Profile	Count	Length
IFB	IFB 70x40		8	107 7/8"

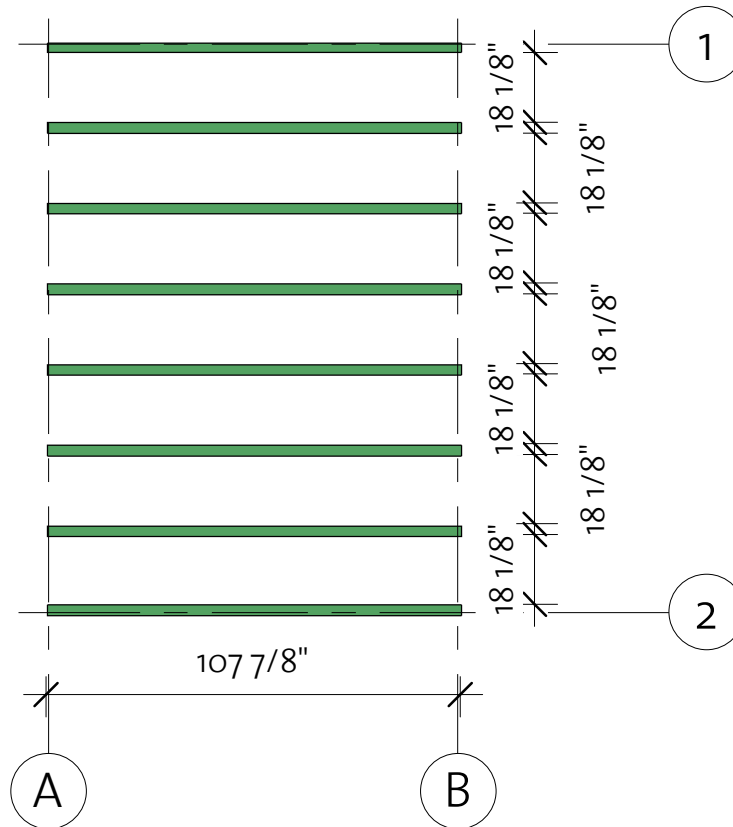



Scion 40 (108 1/4" x 149 5/8")

Floor Plan

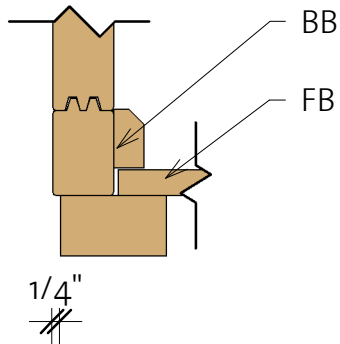
① Baseboard



Floor Schedule				
Mark	Type	Profile	Count	Length
FB	FB 17x114		24	146 1/4"
BB1	BB 20x40		2	108 1/4"
BB2	BB 20x40		2	149 5/8"

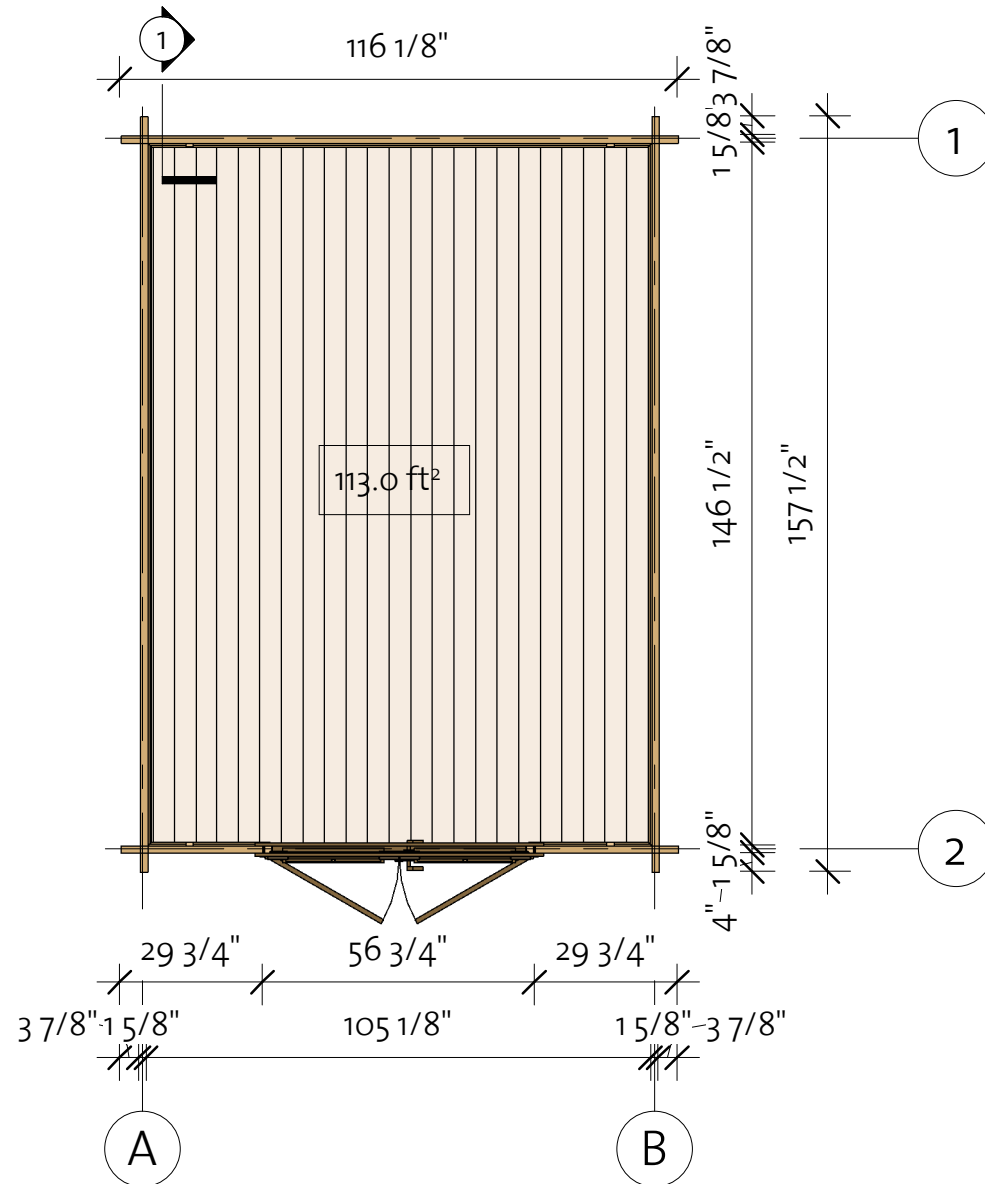

Scion 40 (108 1/4" x 149 5/8")

Wall 1

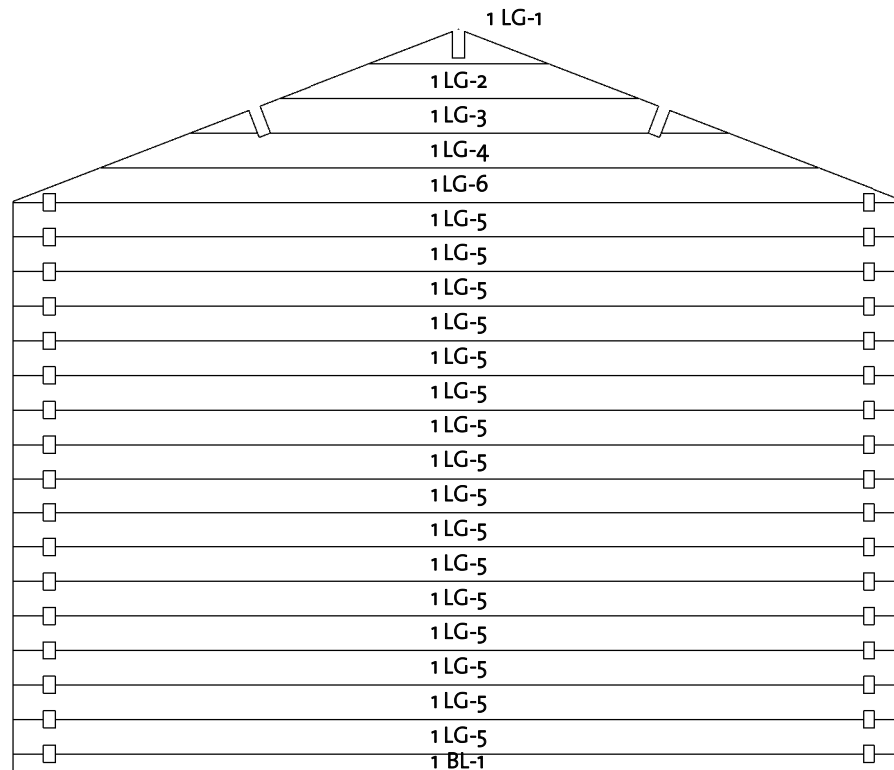
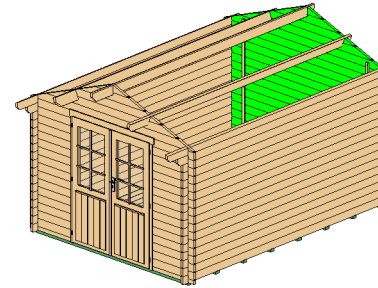



Wall 1			
Mark	Profile	Count	Cut Length

1BL-1	40X57	1	116 1/8"
1LG-1 *	40X114	1	23 3/8"
1LG-2 *	40X114	1	46 3/4"
1LG-3 *	40X114	1	70 1/8"
1LG-4 *	40X114	1	93 1/2"
1LG-5	40X114	16	116 1/8"
1LG-6 *	40X114	1	116 1/8"

* Gable - delivered premounted

Log Profile Wall 1	
Profile	Profile

40X57	
40X114	

Scion 40 (108 1/4" x 149 5/8")

Wall 2

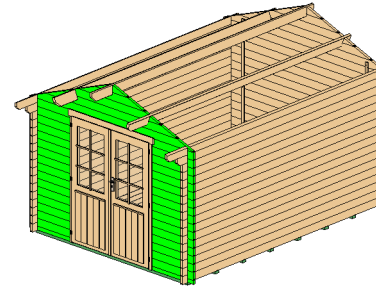



Wall 2			
Mark	Profile	Count	Cut Length

2BL-1	40X57	2	29 3/4"
2LG-1 *	40X114	1	23 3/8"
2LG-2	40X114	32	29 3/4"
2LG-3 *	40X114	1	46 3/4"
2LG-4 *	40X114	1	70 1/8"
2LG-5 *	40X114	1	93 1/2"
2LG-6 *	40X114	1	116 1/8"

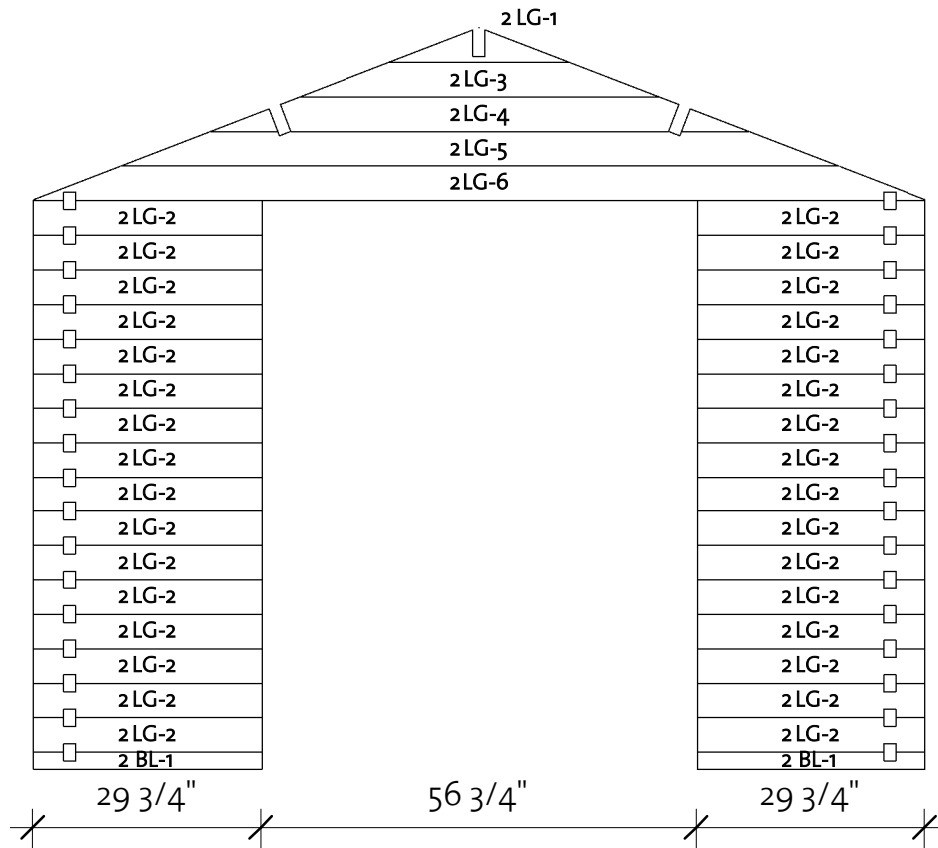
* Gable - delivered premounted



Log Profile Wall 2	
Profile	Profile

40X57	
40X114	

Scion 40 (108 1/4" x 149 5/8")

Wall A

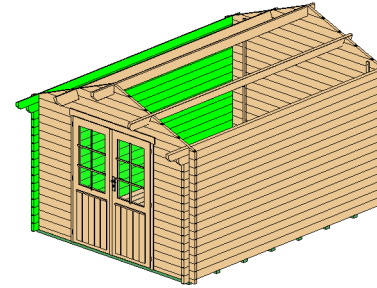

Wall A			
Mark	Profile	Count	Cut Length
ALG-1	40x114	15	157 1/2"
ALG-2	40x114	1	161 3/8"
ATL-1	40x114	1	169 1/4"

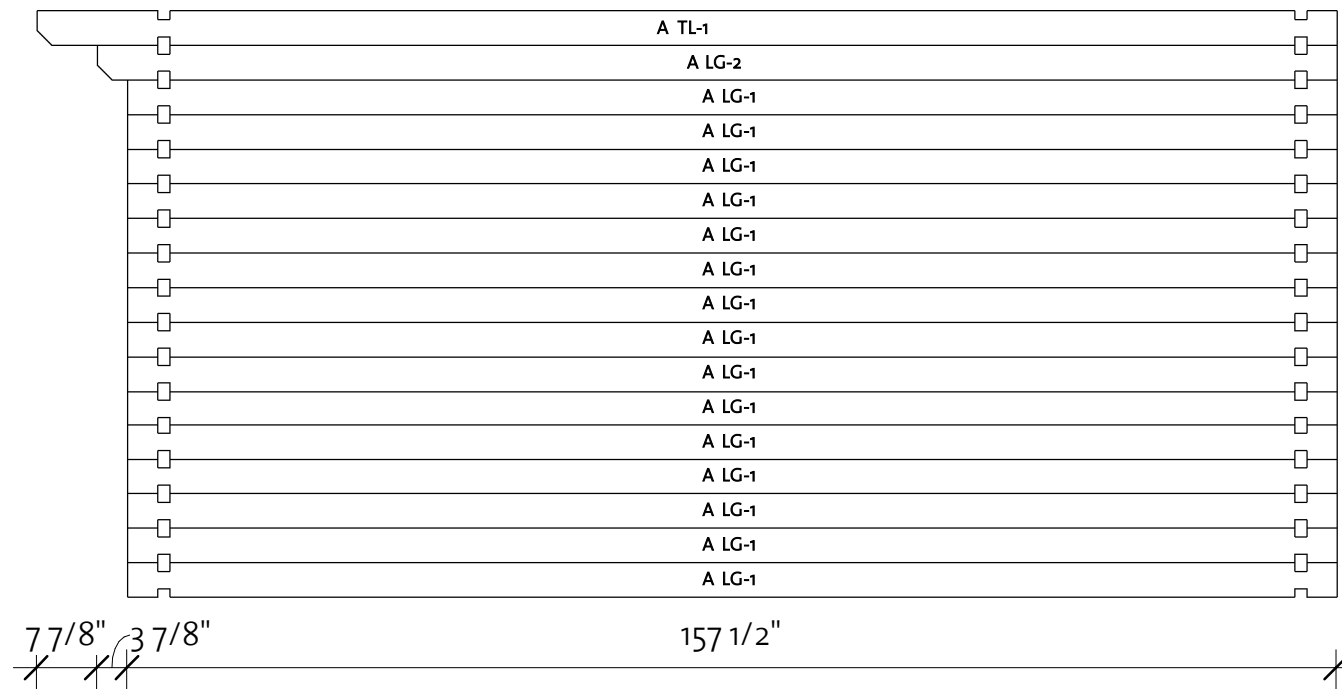

Log Profile Wall A	
Profile	Profile
40x114	
40x114	

Scion 40 (108 1/4" x 149 5/8")

Wall B

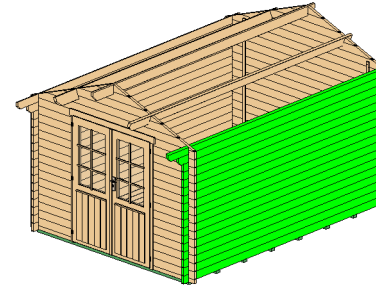

Wall B			
Mark	Profile	Count	Cut Length

BLG-1	40X114	15	157 1/2"
BLG-2	40X114	1	161 3/8"
BTL-1	40X114	1	169 1/4"

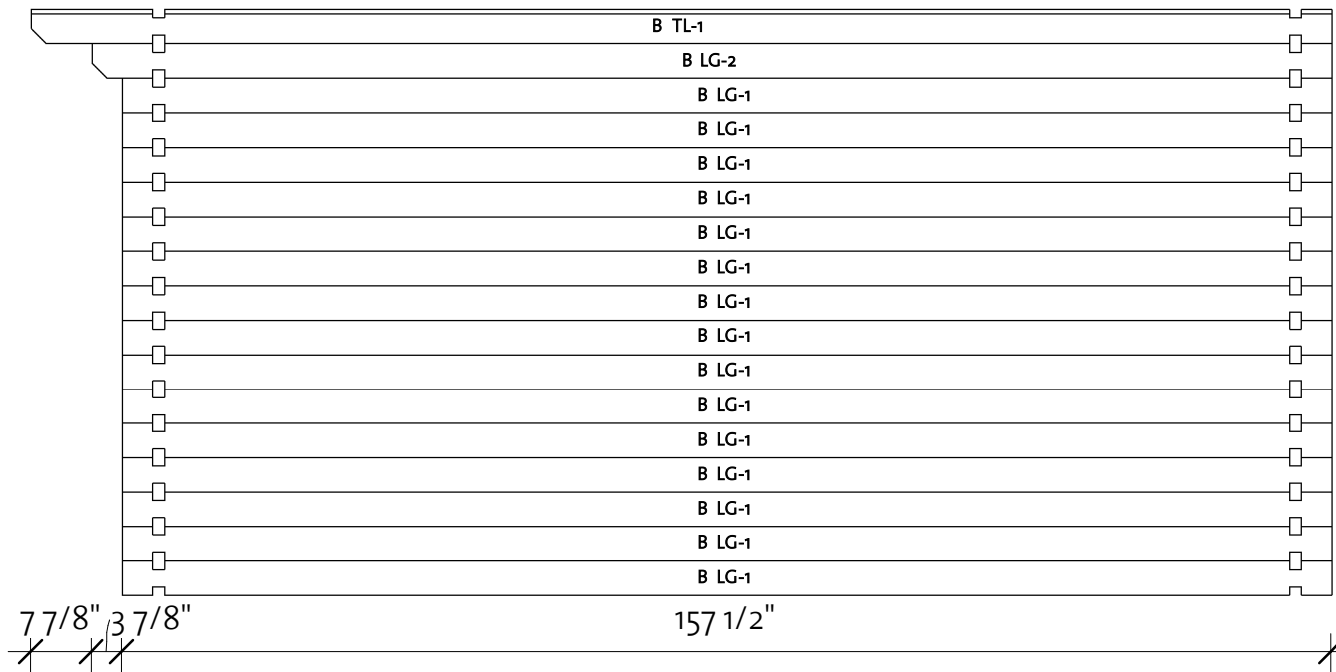





Log Profile Wall B	
Profile	Profile

40X114	
40X114	

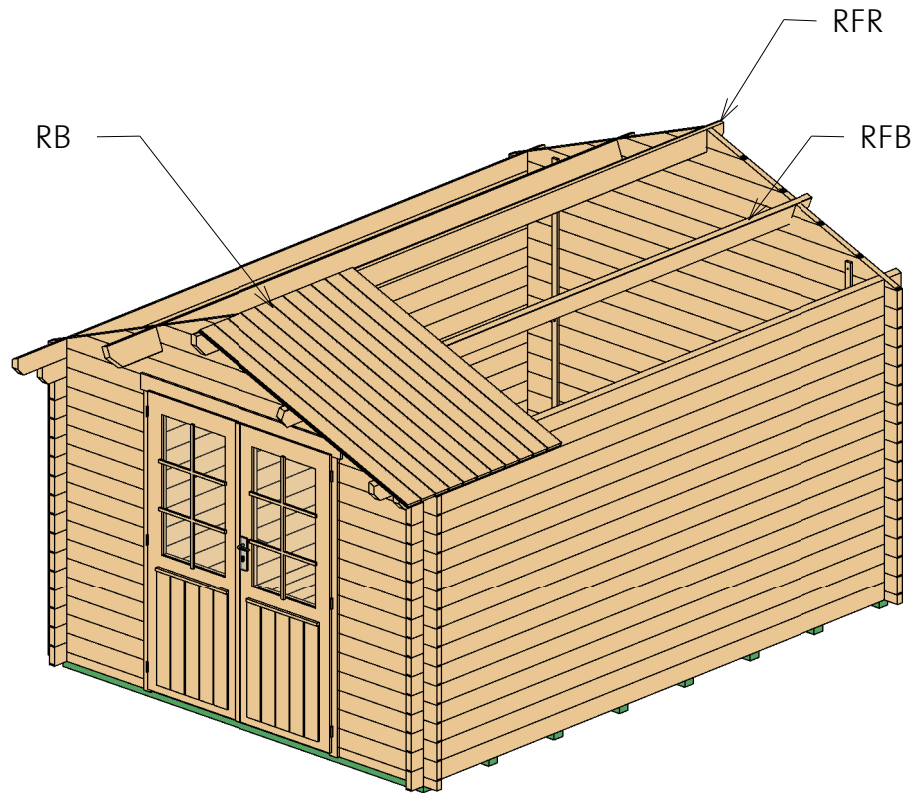
Scion 40 (108 1/4" x 149 5/8")

Roof 1



Roof				
Mark	Type	Profile	Count	Length
RFR	Ridge 40x143		1	169 1/4"
RFB	Beam 40x143		2	169 1/4"
RB	17x114		78	66 3/4"

Scion 40 (108 1/4" x 149 5/8")

Roof 2

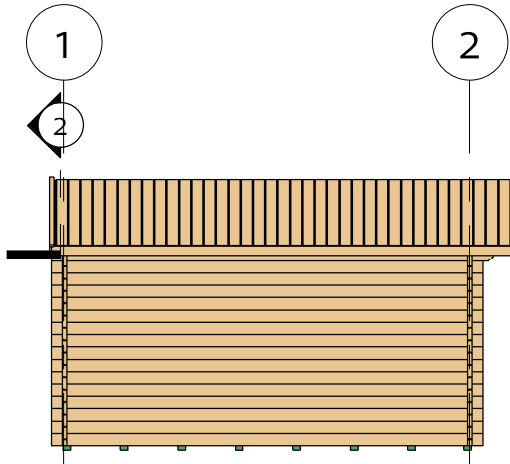

② Fascia

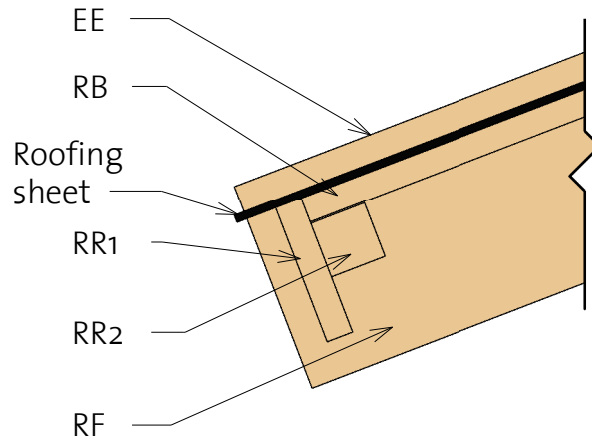

③ Roof Reinforcement

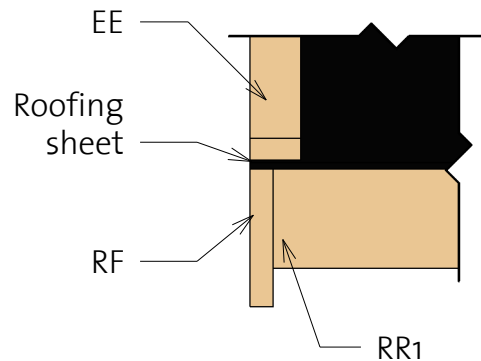
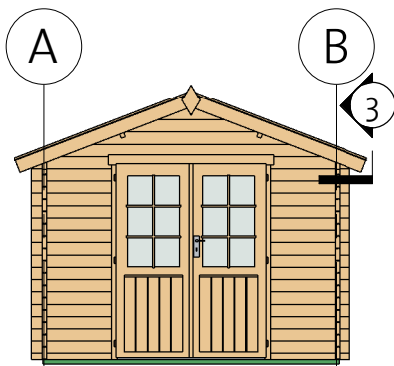

Fascia Schedule				
Mark	Type	Profile	Count	Length
EE	Eave Edging 18x40		4	68 5/8"
RF	Roof Fascia 18x120		4	68 5/8"
RR1	Roof reinforcement 18x95		2	169 1/4"
RR2	Roof reinforcement 38x38		2	169 1/4"

Scion 40 (108 1/4" x 149 5/8")

Extras

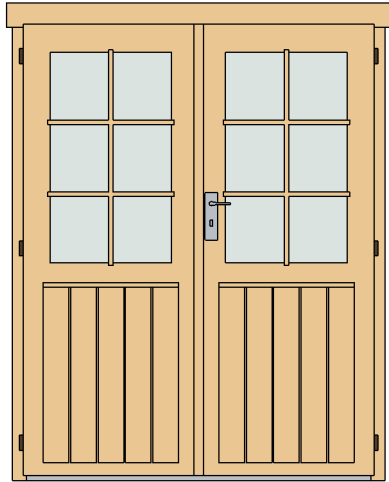

Door Schedule				
Mark	Type	Width	Height	Count
CDD12R	Classic double door 12 right	56 1/8"	72 1/4"	1
DCB6	Door Crossbar 6	--	--	1/8"

Fasteners & Extras		
Name	Type	Count

Hitblock	300-400 mm	
Screws	5,0 x 70	10
Bolts	M8 x 70	12
Screws	6,0 x 140	35
Nails	1,4 x 40	35
Screws	4,0 x 40	560

Model	Count	Length
-------	-------	--------

Windboard 18x40	4	86 5/8"
--------------------	---	---------



Family	Count
--------	-------





Romb	2
------	---





Scion 40 (108 1/4"x149 5/8")

List of all items 1

Roof				
Mark	Type	Profile	Count	Length
RFR	Ridge 40x143		1	169 1/4"
RFB	Beam 40x143		2	169 1/4"
RB	17x114		78	66 3/4"

Fascia Schedule				
Mark	Type	Profile	Count	Length
EE	Eave Edging 18x40		4	68 5/8"
RF	Roof Fascia 18x120		4	68 5/8"
RR1	Roof reinforcement 18x95		2	169 1/4"
RR2	Roof reinforcement 38x38		2	169 1/4"

Floor Schedule				
Mark	Type	Profile	Count	Length
FB	FB 17x114		24	146 1/4"

Impregnated foundation beams				
Mark	Type	Profile	Count	Length
IFB	IFB 70x40		8	107 7/8"

BB1	BB 20x40		2	108 1/4"
BB2	BB 20x40		2	149 5/8"

Scion 40 (108 1/4" x 149 5/8")

List of all items 2

Wall 1			
Mark	Profile	Count	Cut Length

1BL-1	40X57	1	116 1/8"
1LG-1 *	40X114	1	23 3/8"
1LG-2 *	40X114	1	46 3/4"
1LG-3 *	40X114	1	70 1/8"
1LG-4 *	40X114	1	93 1/2"
1LG-5	40X114	16	116 1/8"
1LG-6 *	40X114	1	116 1/8"

Wall 2			
Mark	Profile	Count	Cut Length

2BL-1	40X57	2	29 3/4"
2LG-1 *	40X114	1	23 3/8"
2LG-2	40X114	32	29 3/4"
2LG-3 *	40X114	1	46 3/4"
2LG-4 *	40X114	1	70 1/8"
2LG-5 *	40X114	1	93 1/2"
2LG-6 *	40X114	1	116 1/8"

* Gable - delivered premounted



Wall A			
Mark	Profile	Count	Cut Length

ALG-1	40X114	15	157 1/2"
ALG-2	40X114	1	161 3/8"
ATL-1	40X114	1	169 1/4"

Wall B			
Mark	Profile	Count	Cut Length

BLG-1	40X114	15	157 1/2"
BLG-2	40X114	1	161 3/8"
BTL-1	40X114	1	169 1/4"

Log Profiles	
Profile	Profile

40X57	
40X114	

Log Profiles	
Profile	Profile

40X114	
--------	---