

Tina B 28 (78 3/4" x 102 3/8")

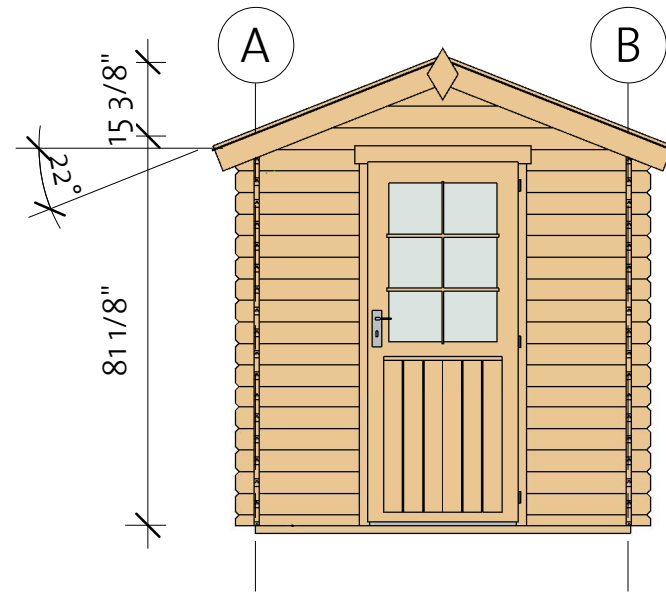

Tina B 28 (78 3/4" x 102 3/8")

Foundation

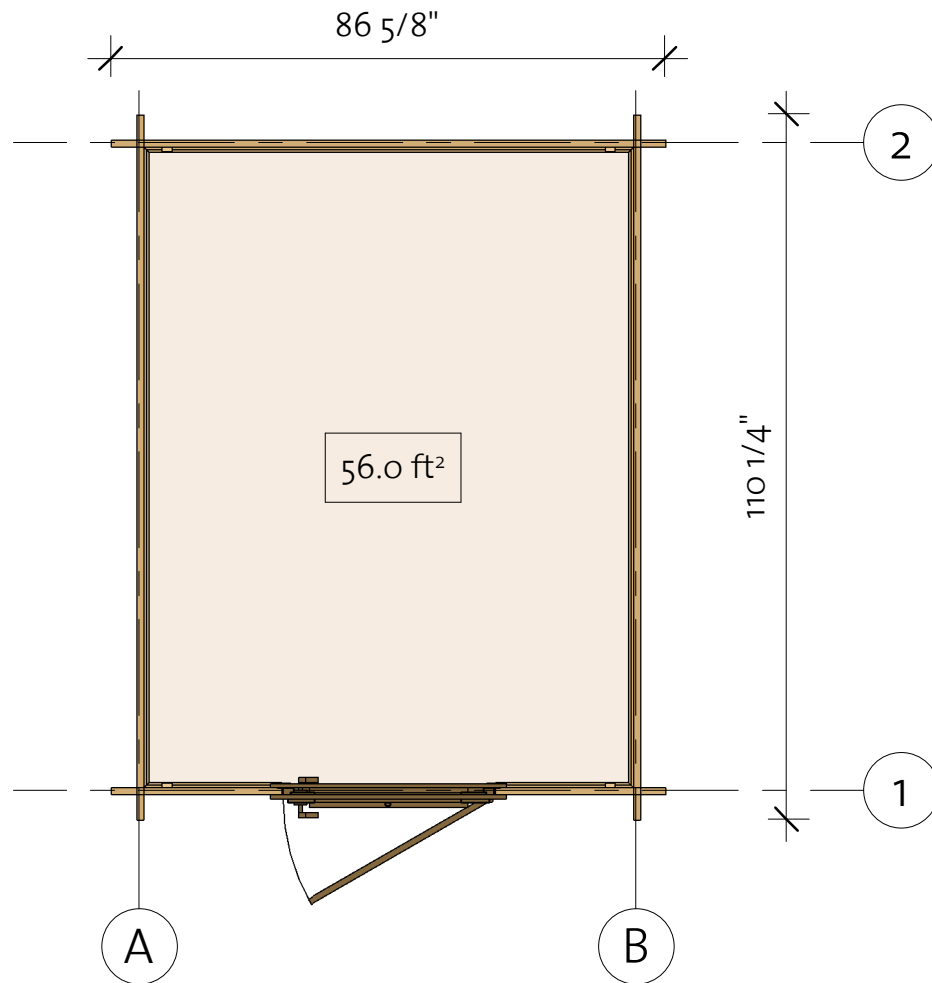
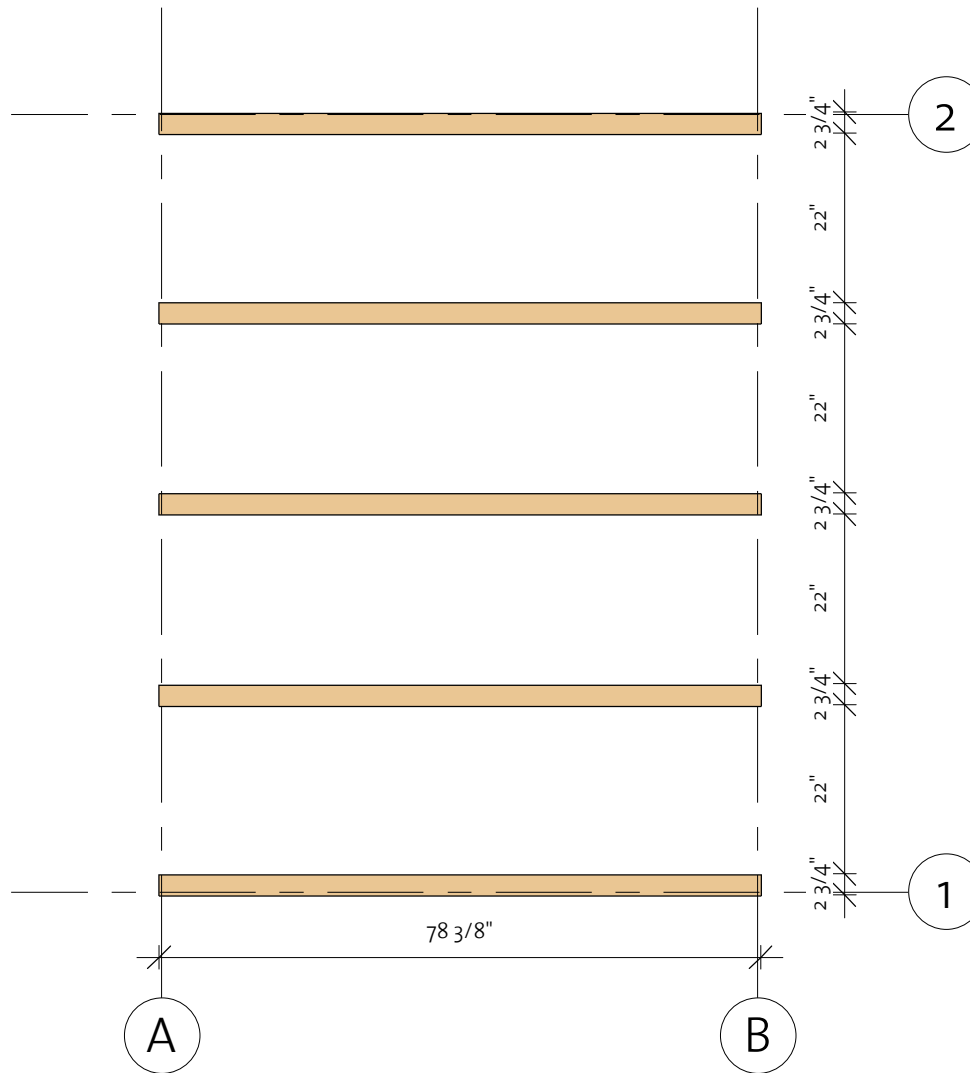

Impregnated foundation beams				
Mark	Type	Profile	Count	Length

IFB	IFB 70x40		5	78 3/8"
-----	--------------	---	---	---------

Tina B 28 (78 3/4" x 102 3/8")

Floor Plan

① Baseboard

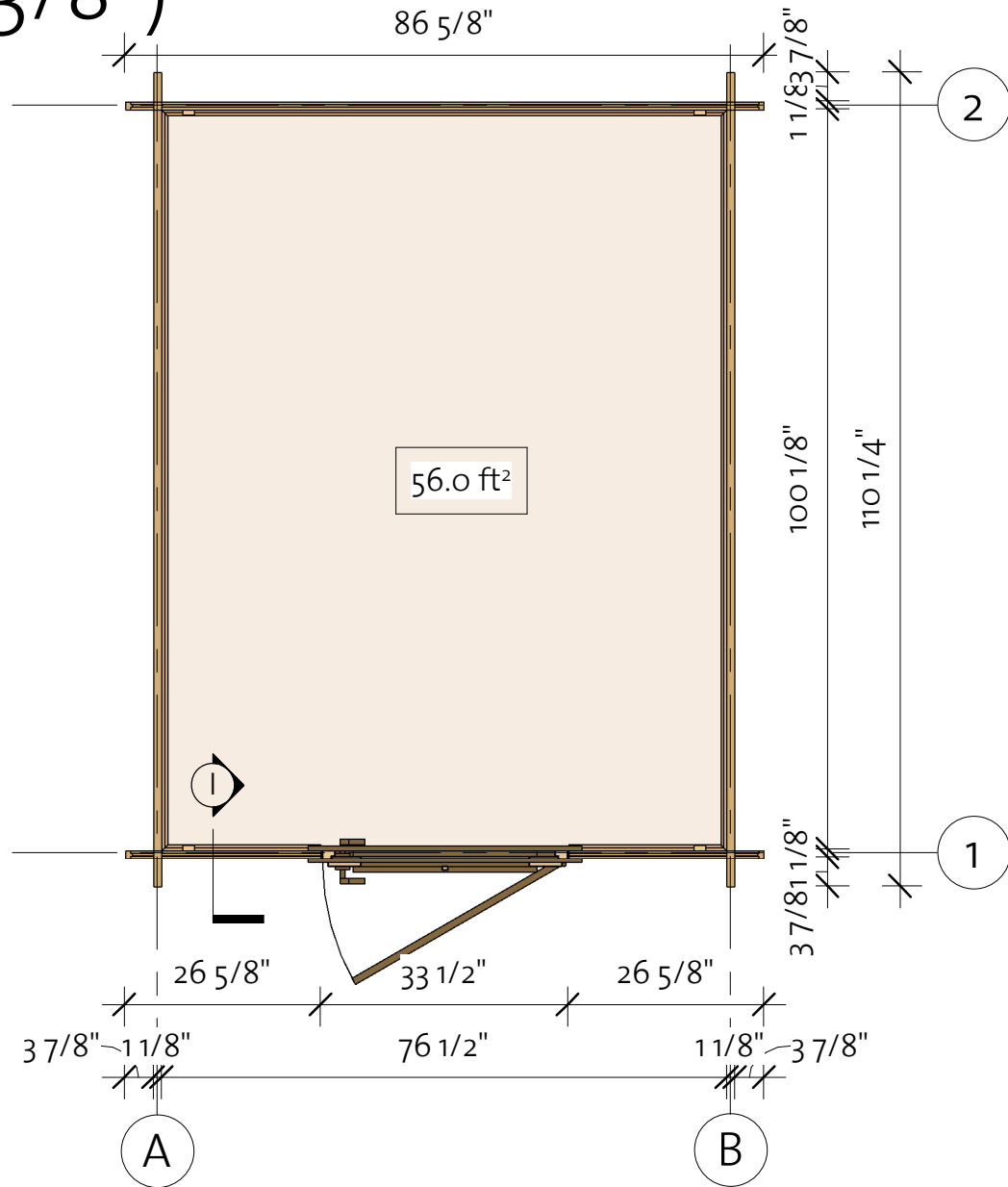
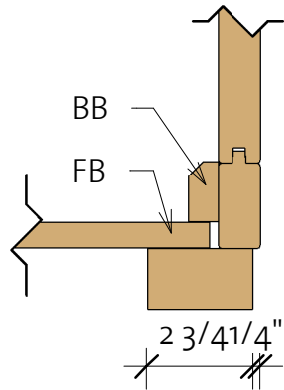

Floor Schedule

Mark	Type	Profile	Count	Length
FB	FB 17X114		18	99 7/8"
BB	BB 20X40		2	78 3/4"
BB	BB 20X40		2	102 3/8"

Tina B 28 (78 3/4" x 102 3/8")

Wall 1

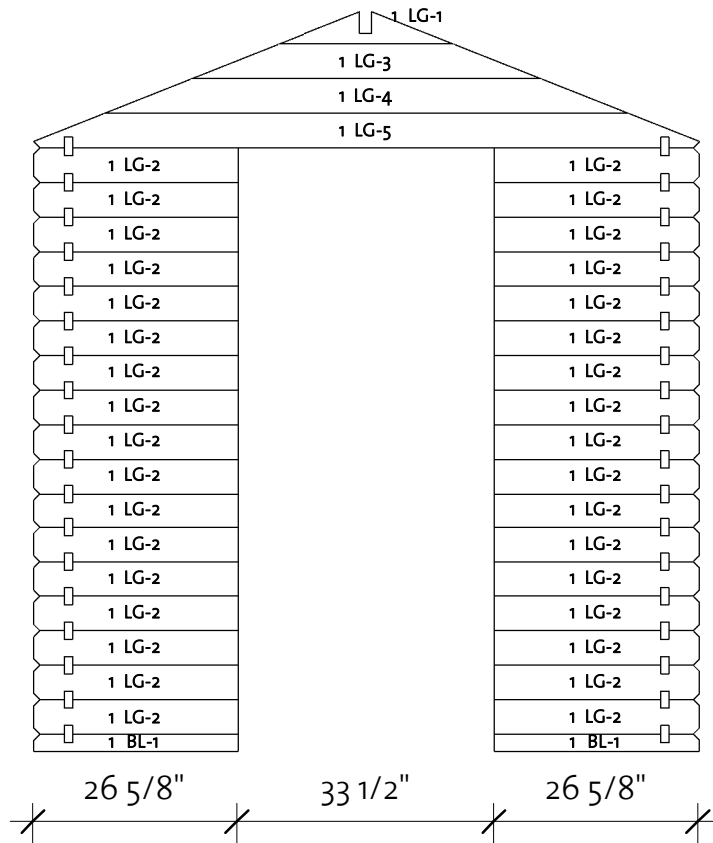
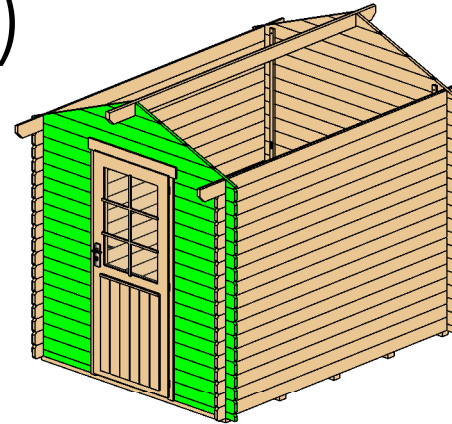

Wall 1			
Mark	Profile	Count	Cut Length

1BL-1	28x57	2	26 5/8"
1LG-1 *	28x114	1	22 3/4"
1LG-2	28x114	34	26 5/8"
1LG-3 *	28x114	1	45 1/2"
1LG-4 *	28x114	1	68 1/8"
1LG-5 *	28x114	1	86 5/8"

* Gable - delivered premounted

Log Profile Wall 1	
Profile	Profile

28x57	
28x114	

Tina B 28 (78 3/4" x 102 3/8")

Wall A

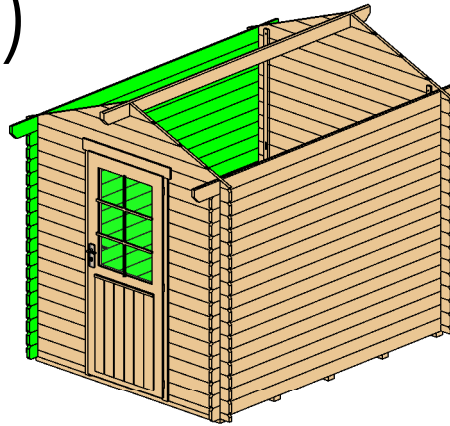

Wall A			
Mark	Profile	Count	Cut Length

ALG-1	28x114	17	110 1/4"
ATL-1	28x123	1	122"

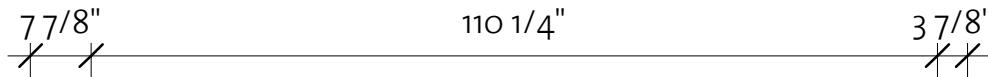
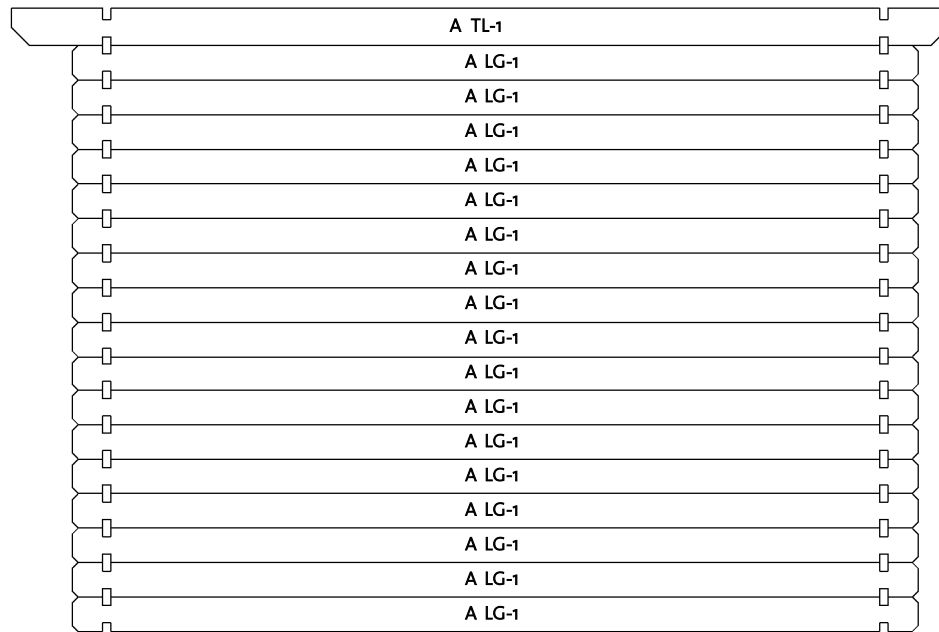

Log Profile Wall A	
Profile	Profile

28x114	
28x123	

Tina B 28 (78 3/4" x 102 3/8")

Wall B

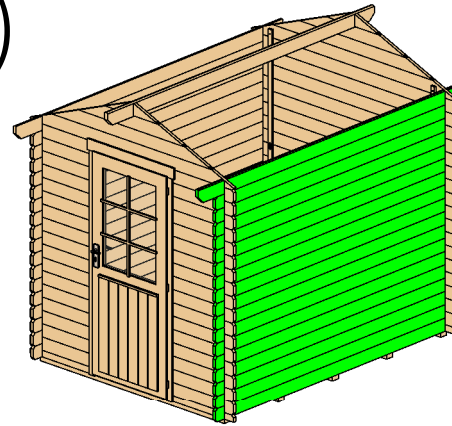

Wall B			
Mark	Profile	Count	Cut Length

BLG-1	28x114	17	110 1/4"
BTL-1	28x123	1	122"

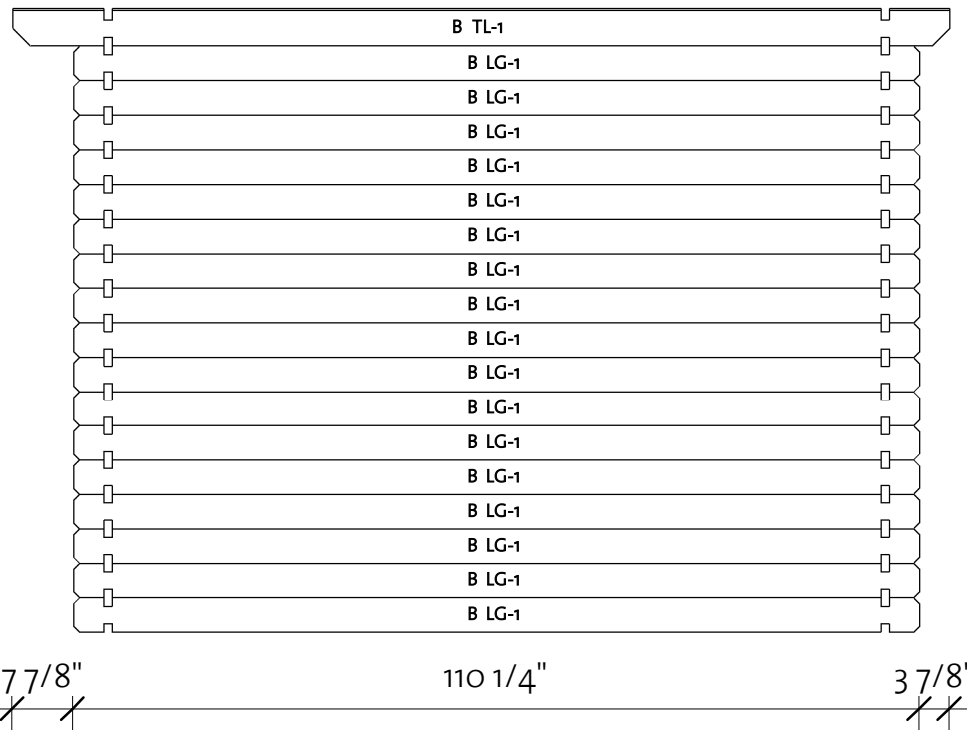



Log Profile Wall B	
Profile	Profile

28x114	
28x123	

Tina B 28 (78 3/4" x 102 3/8")

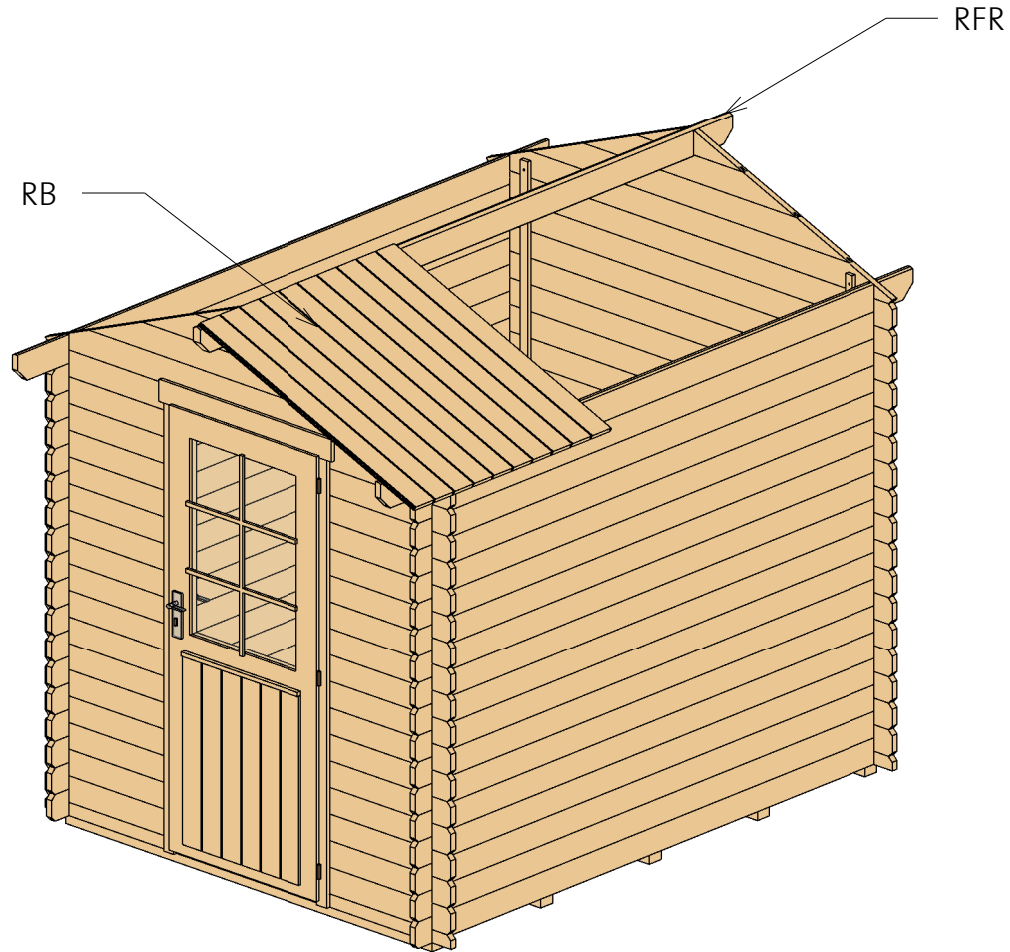
Roof 1



Roof				
Mark	Type	Profile	Count	Length
RFR	Ridge 40x120		1	122"
RB	17x114		56	49 5/8"

Tina B 28 (78 3/4" x 102 3/8")

Roof 2

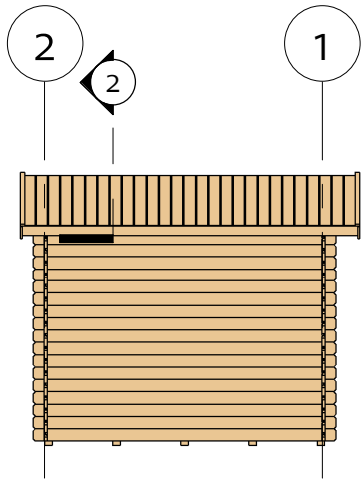

② Facia

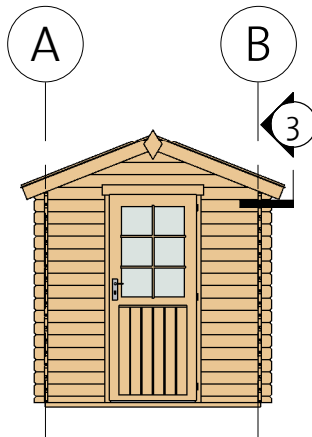
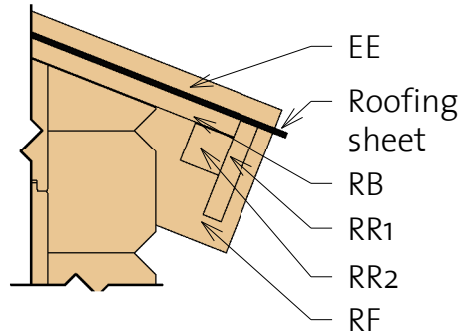

③ Roof Reinforcement

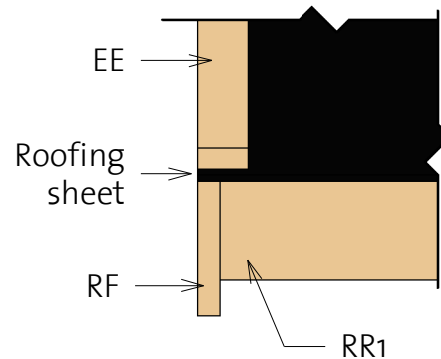

Fascia Schedule

Mark	Type	Profile	Count	Length
EE	Eave Edging 18x40		4	51 1/8"
RF	Roof Fascia 18x120		4	51 1/8"
RR1	Roof reinforcement 18x95		2	122"
RR2	Roof reinforcement 38x38		2	122"

Tina B 28 (78 3/4" x 102 3/8")

Extras



Door Schedule				
Mark	Type	Width	Height	Count
BD3R	Basic door 3 right	33 1/8"	77"	1
DCB6	Door Crossbar 6	--	--	0"

Fasteners & Extras		
Name	Type	Count
Hitblock	300-400 mm	
Screws	5,0 x 70	10
Bolts	M8 x 60	12
Screws	6,0 x 140	25
Nails	1,4 x 40	25
Screws	4,0 x 40	300

Family	Count	Length
--------	-------	--------

Windboard 18x40	4	86 5/8"
-----------------	---	---------

Family	Count
--------	-------

Romb	2
------	---





Tina B 28 (78 3/4"x102 3/8")

List of all items 1





Impregnated foundation beams

Mark	Type	Profile	Count	Length
IFB	IFB 70x40		5	78 3/8"



Floor Schedule

Mark	Type	Profile	Count	Length
FB	FB 17x114		18	99 7/8"
BB	BB 20x40		2	78 3/4"
BB	BB 20x40		2	102 3/8"

Fascia Schedule

Mark	Type	Profile	Count	Length
EE	Eave Edging 18x40		4	51 1/8"
RF	Roof Fascia 18x120		4	51 1/8"
RR1	Roof reinforcement 18x95		2	122"
RR2	Roof reinforcement 38x38		2	122"

Roof

Mark	Type	Profile	Count	Length
RFR	Ridge 40x120		1	122"
RB	17x114		56	49 5/8"

Tina B 28 (78 3/4"x102 3/8")

List of all items 2

Wall 1			
Mark	Profile	Count	Cut Length

1BL-1	28x57	2	26 5/8"
1LG-1 *	28x114	1	22 3/4"
1LG-2	28x114	34	26 5/8"
1LG-3 *	28x114	1	45 1/2"
1LG-4 *	28x114	1	68 1/8"
1LG-5 *	28x114	1	86 5/8"

Wall 2			
Mark	Profile	Count	Cut Length

2BL-1	28x57	1	86 5/8"
2LG-1 *	28x114	1	22 3/4"
2LG-2 *	28x114	1	45 1/2"
2LG-3 *	28x114	1	68 1/8"
2LG-4 *	28x114	1	86 5/8"
2LG-5	28x114	17	86 5/8"

* Gable - delivered premounted



Wall A			
Mark	Profile	Count	Cut Length

ALG-1	28x114	17	110 1/4"
ATL-1	28x123	1	122"

Wall B			
Mark	Profile	Count	Cut Length

BLG-1	28x114	17	110 1/4"
BTL-1	28x123	1	122"

Log Profiles	
Profile	Profile

28x57	
28x114	

Log Profiles	
Profile	Profile

28x123	
--------	---