

# Tiina B 28 (200x260)

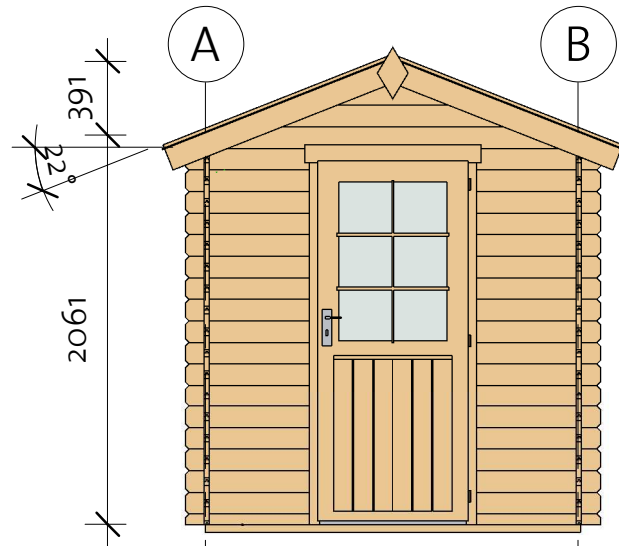

# Tiina B 28 (200x260)

Foundation

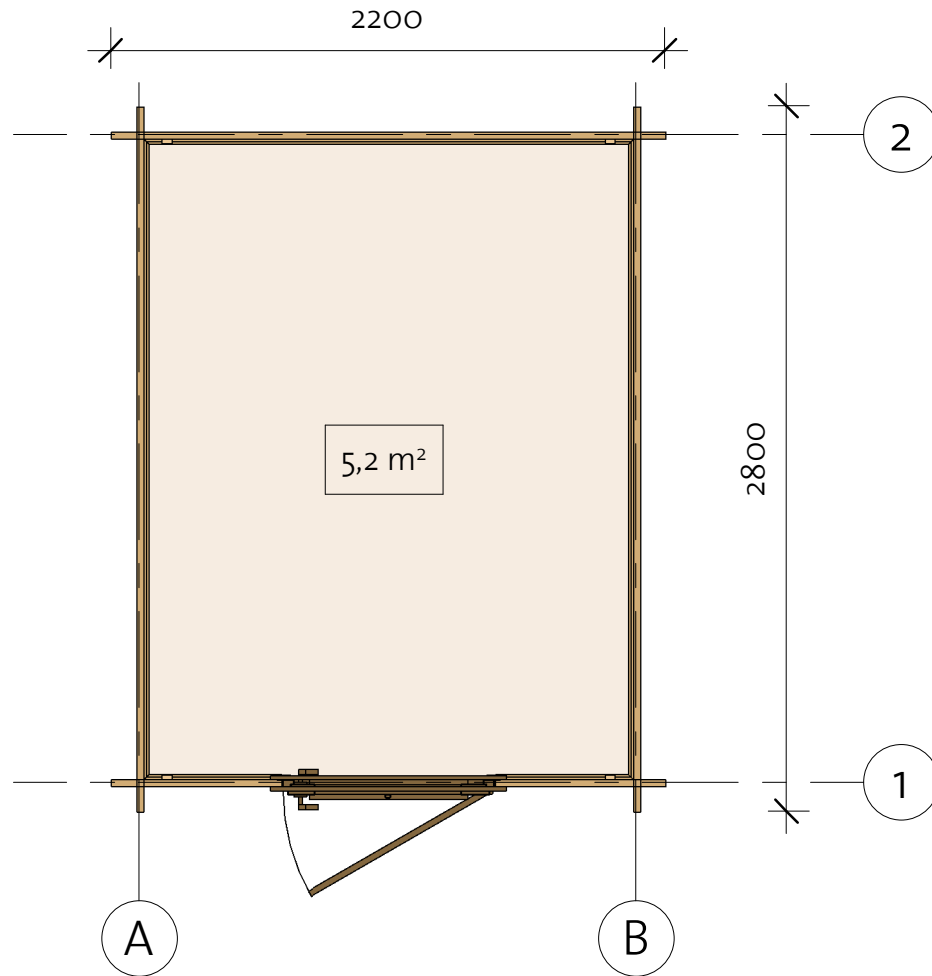
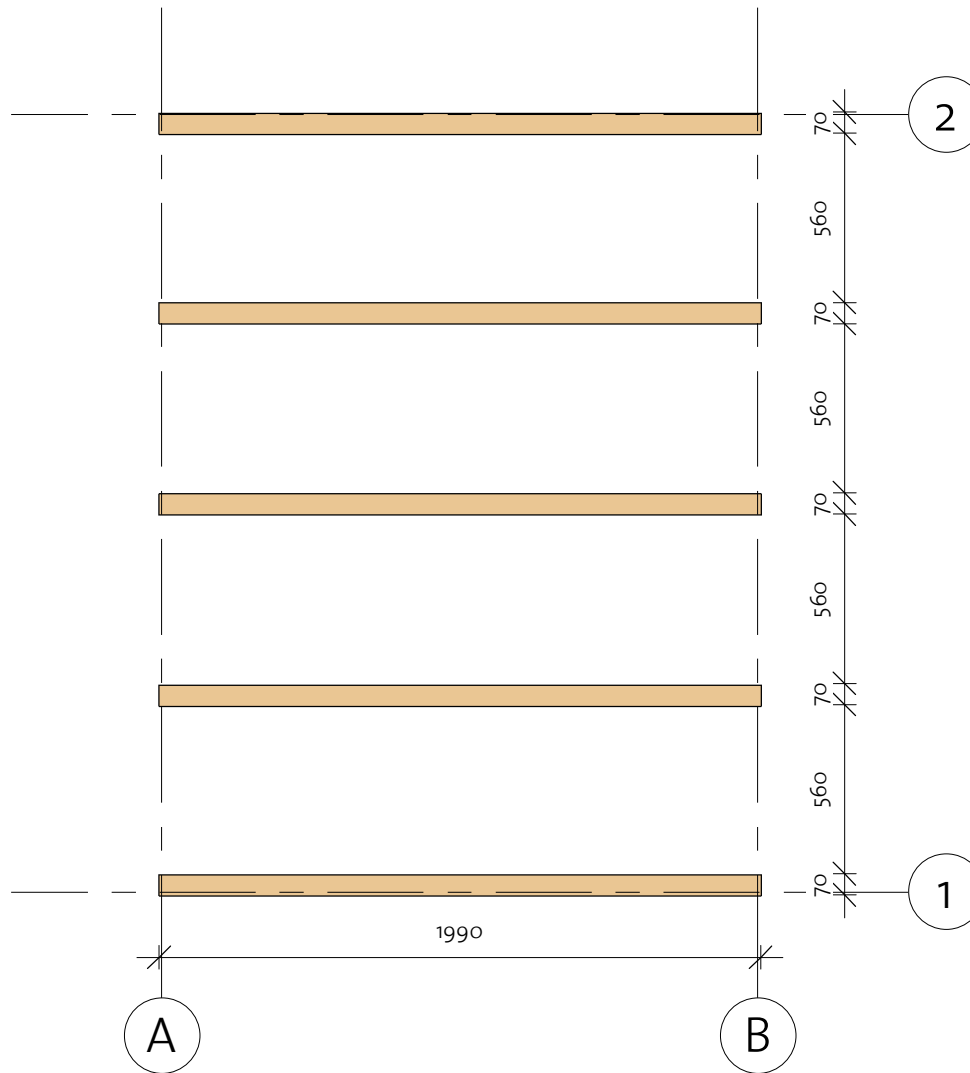

Impregnated foundation beams				
Mark	Type	Profile	Count	Length

IFB	IFB 70x40		5	1990
-----	--------------	---	---	------



# Tiina B 28 (200x260)

Floor Plan

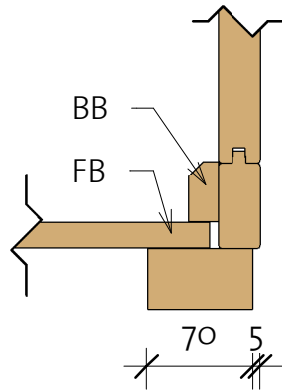
① Baseboard



Floor Schedule

Mark	Type	Profile	Count	Length
FB	FB 17X114		18	2538
BB	BB 20X40		2	2000
BB	BB 20X40		2	2600

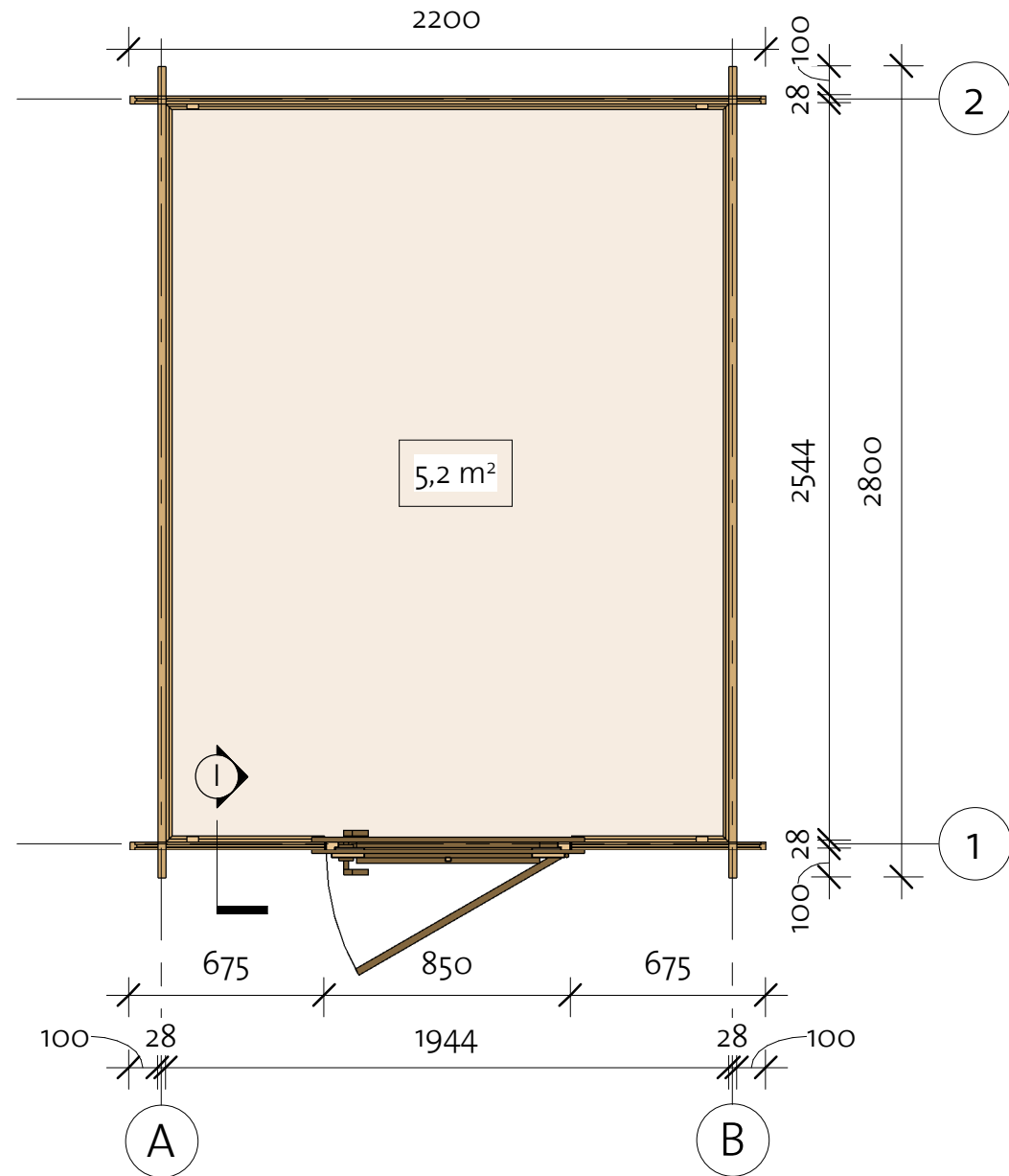

# Tiina B 28 (200x260)

Wall 1

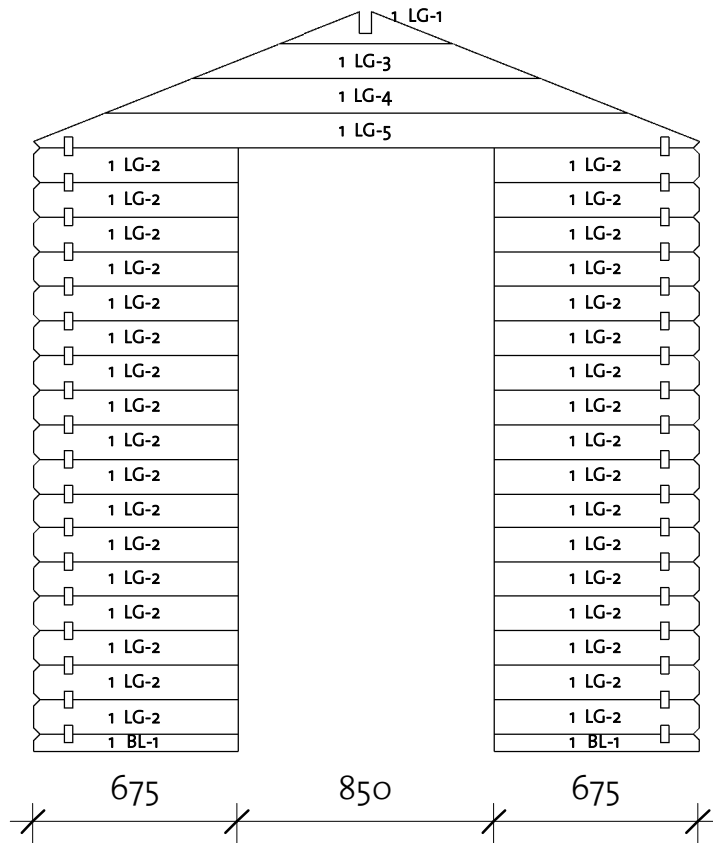
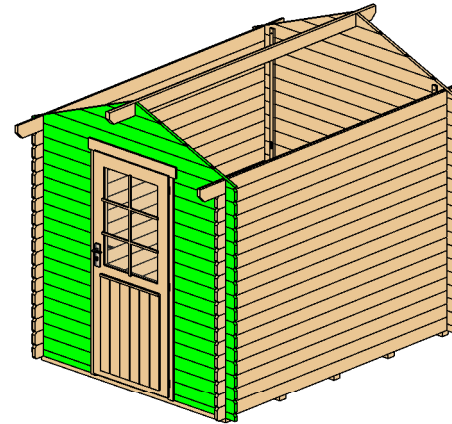

Wall 1			
Mark	Profile	Count	Cut Length

1BL-1	28x57	2	675
1LG-1 *	28x114	1	578
1LG-2	28x114	34	675
1LG-3 *	28x114	1	1155
1LG-4 *	28x114	1	1731
1LG-5 *	28x114	1	2200

\* Gable - delivered premounted

Log Profile Wall 1	
Profile	Profile

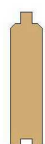
28x57	
28x114	

# Tiina B 28 (200x260)

Wall 2

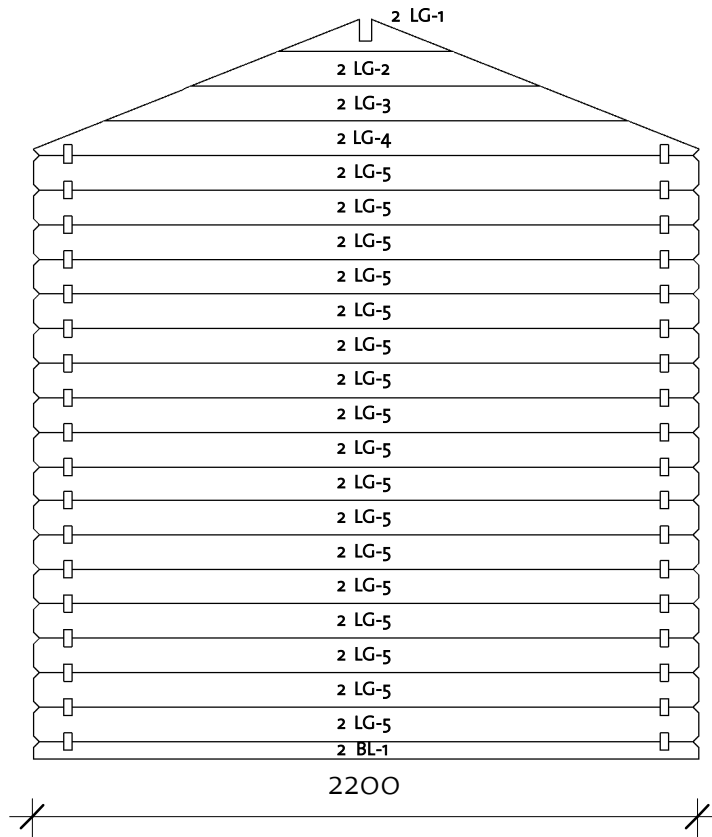
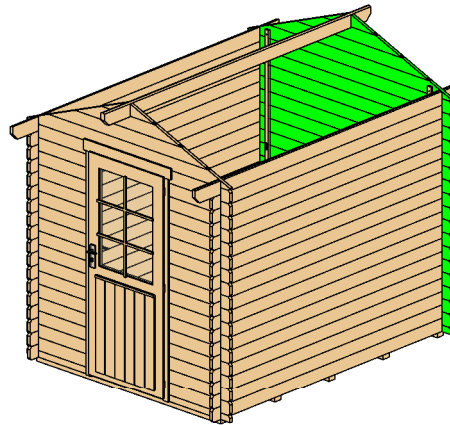



Wall 2			
Mark	Profile	Count	Cut Length

2BL-1	28x57	1	2200
2LG-1 *	28x114	1	578
2LG-2 *	28x114	1	1155
2LG-3 *	28x114	1	1731
2LG-4 *	28x114	1	2200
2LG-5	28x114	17	2200

\* Gable - delivered premounted

Log Profile Wall 2	
Profile	Profile

28x57	
28x114	

# Tiina B 28 (200x260)

Wall A

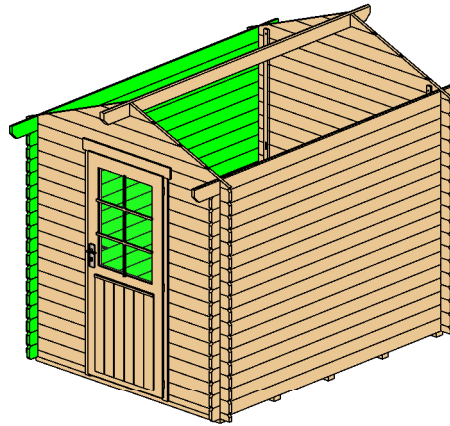

Wall A			
Mark	Profile	Count	Cut Length

ALG-1	28x114	17	2800
ATL-1	28x123	1	3100

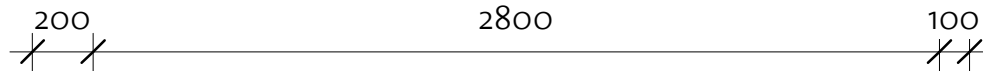
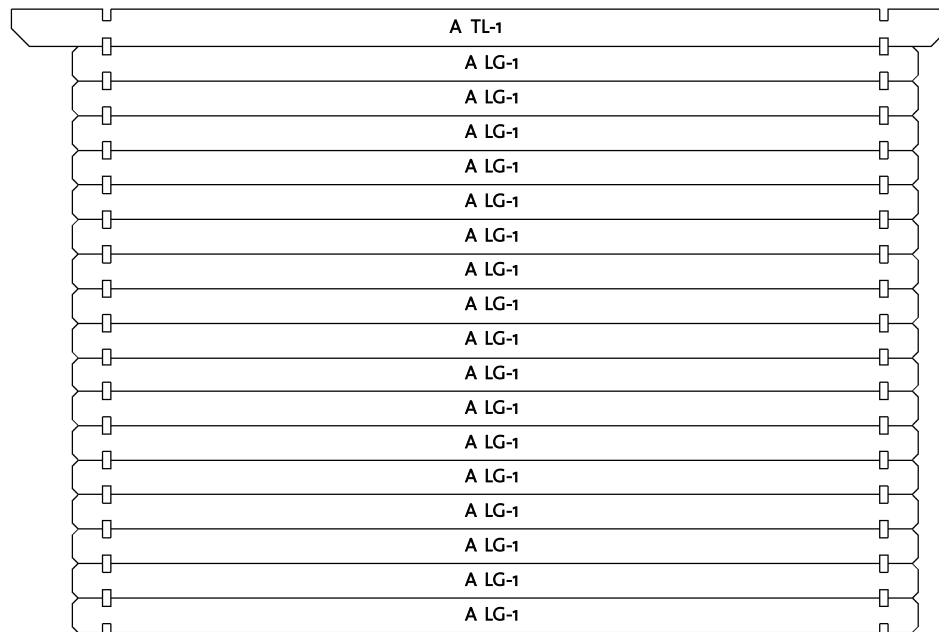

Log Profile Wall A	
Profile	Profile

28x114	
28x123	

# Tiina B 28 (200x260)

Wall B

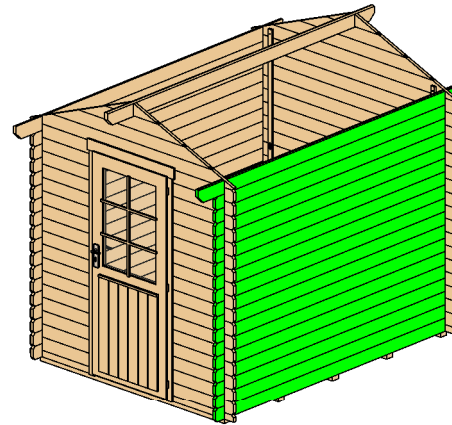

Wall B			
Mark	Profile	Count	Cut Length

BLG-1	28x114	17	2800
BTL-1	28x123	1	3100

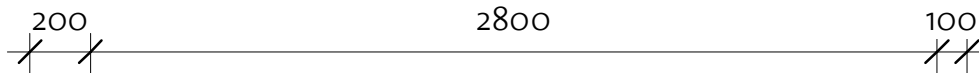
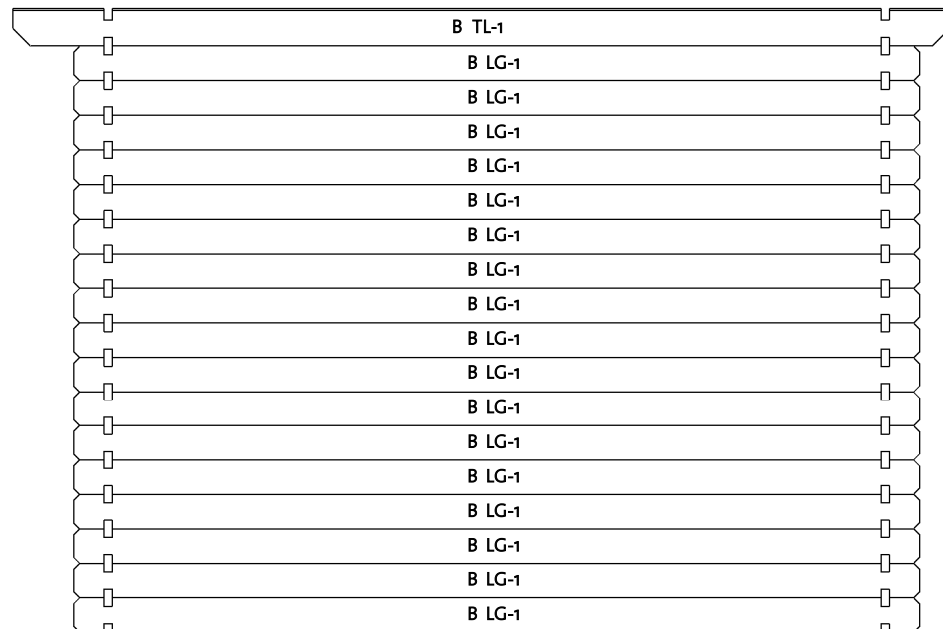



Log Profile Wall B	
Profile	Profile

28x114	
28x123	

# Tiina B 28 (200x260)

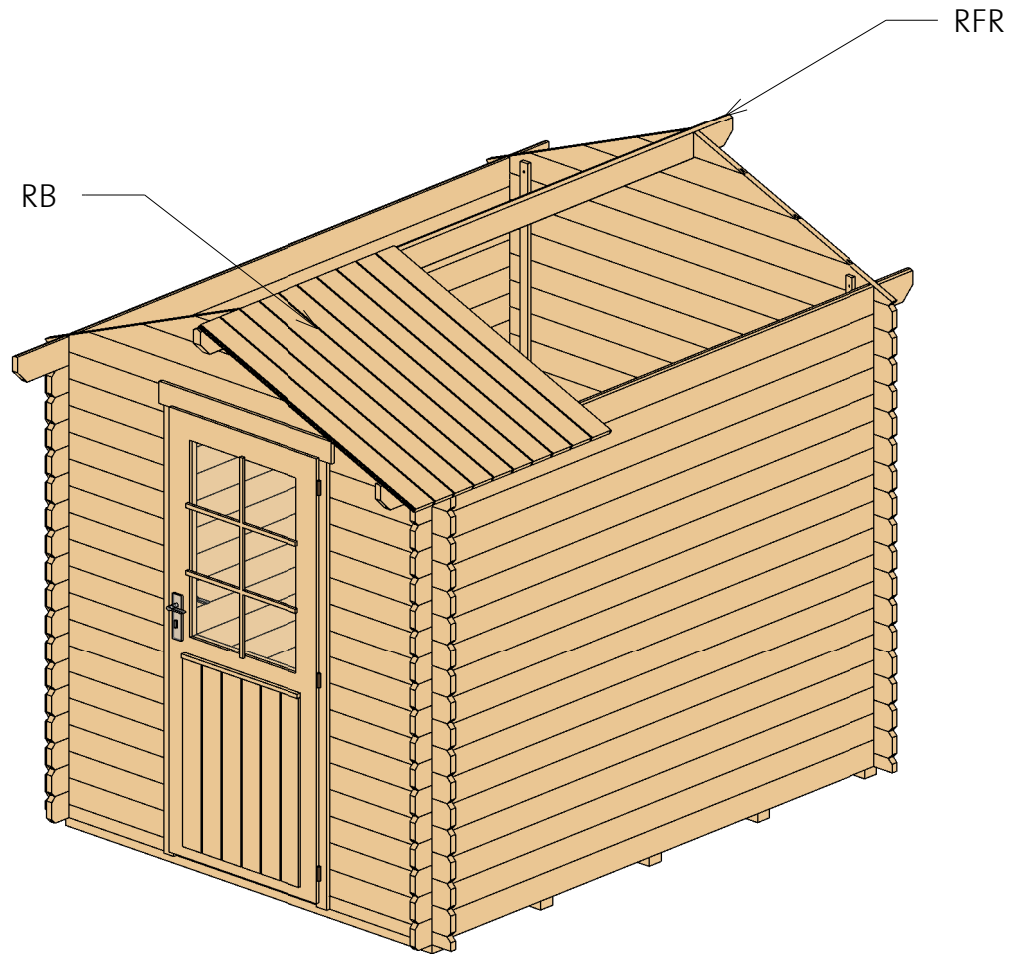
Roof 1



Roof				
Mark	Type	Profile	Count	Length
RFR	Ridge 40x120		1	3100
RB	17x114		56	1260



# Tiina B 28 (200x260)

Roof 2

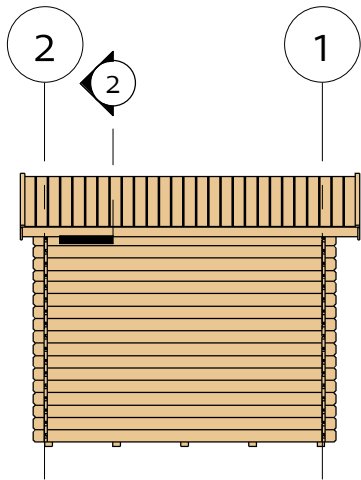

② Facia

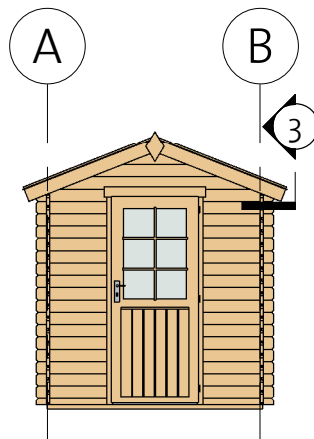
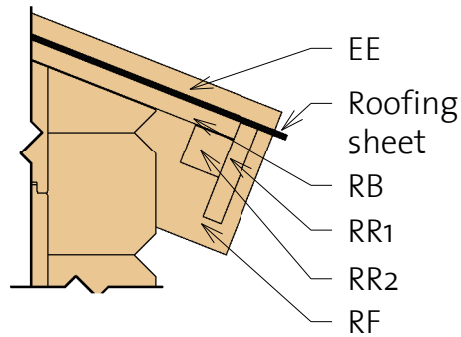

③ Roof Reinforcement

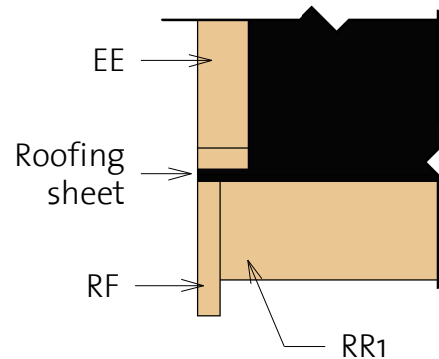

Fascia Schedule

Mark	Type	Profile	Count	Length
EE	Eave Edging 18x40		4	1300
RF	Roof Fascia 18x120		4	1300
RR1	Roof reinforcement 18x95		2	3100
RR2	Roof reinforcement 38x38		2	3100

# Tiina B 28 (200x260)

Extras

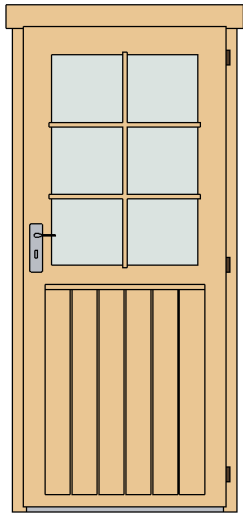

Door Schedule				
Mark	Type	Width	Height	Count

BD3R	Basic door 3 right	840	1955	1
------	--------------------	-----	------	---

DCB6	Door Crossbar 6	--	--	1
------	-----------------	----	----	---

Fasteners & Extras		
Name	Type	Count

Hitblock	300-400 mm	
Screws	5,0 x 70	10
Bolts	M8 x 60	12
Screws	6,0 x 140	25
Nails	1,4 x 40	25
Screws	4,0 x 40	305

Family	Count	Length
--------	-------	--------

Windboard 18x40	4	2200
-----------------	---	------

Family	Count
--------	-------

Romb	2
------	---



91905101\_190530



# Tiina B 28 (200x260)

## List of all items 1





### Impregnated foundation beams

Mark	Type	Profile	Count	Length
IFB	IFB 70x40		5	1990



### Floor Schedule

Mark	Type	Profile	Count	Length
FB	FB 17x114		18	2538
BB	BB 20x40		2	2000
BB	BB 20x40		2	2600

### Fascia Schedule

Mark	Type	Profile	Count	Length
EE	Eave Edging 18x40		4	1300
RF	Roof Fascia 18x120		4	1300
RR1	Roof reinforcement 18x95		2	3100
RR2	Roof reinforcement 38x38		2	3100

### Roof

Mark	Type	Profile	Count	Length
RFR	Ridge 40x120		1	3100
RB	17x114		56	1260

# Tiina B 28 (200x260)

## List of all items 2

Wall 1			
Mark	Profile	Count	Cut Length

1BL-1	28x57	2	675
1LG-1 *	28x114	1	578
1LG-2	28x114	34	675
1LG-3 *	28x114	1	1155
1LG-4 *	28x114	1	1731
1LG-5 *	28x114	1	2200

\* Gable - delivered premounted

Wall 2			
Mark	Profile	Count	Cut Length

2BL-1	28x57	1	2200
2LG-1 *	28x114	1	578
2LG-2 *	28x114	1	1155
2LG-3 *	28x114	1	1731
2LG-4 *	28x114	1	2200
2LG-5	28x114	17	2200



Wall A			
Mark	Profile	Count	Cut Length

ALG-1	28x114	17	2800
ATL-1	28x123	1	3100

Wall B			
Mark	Profile	Count	Cut Length

BLG-1	28x114	17	2800
BTL-1	28x123	1	3100

Log Profiles	
Profile	Profile

28x57	
28x114	

Log Profiles	
Profile	Profile

28x123	
--------	---