

# Peacock Bunkie 40 (142"x109")

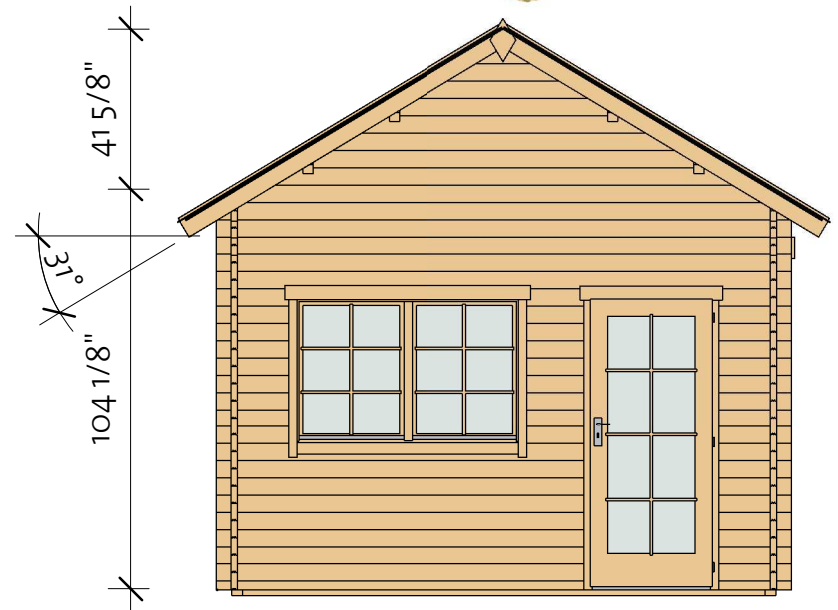

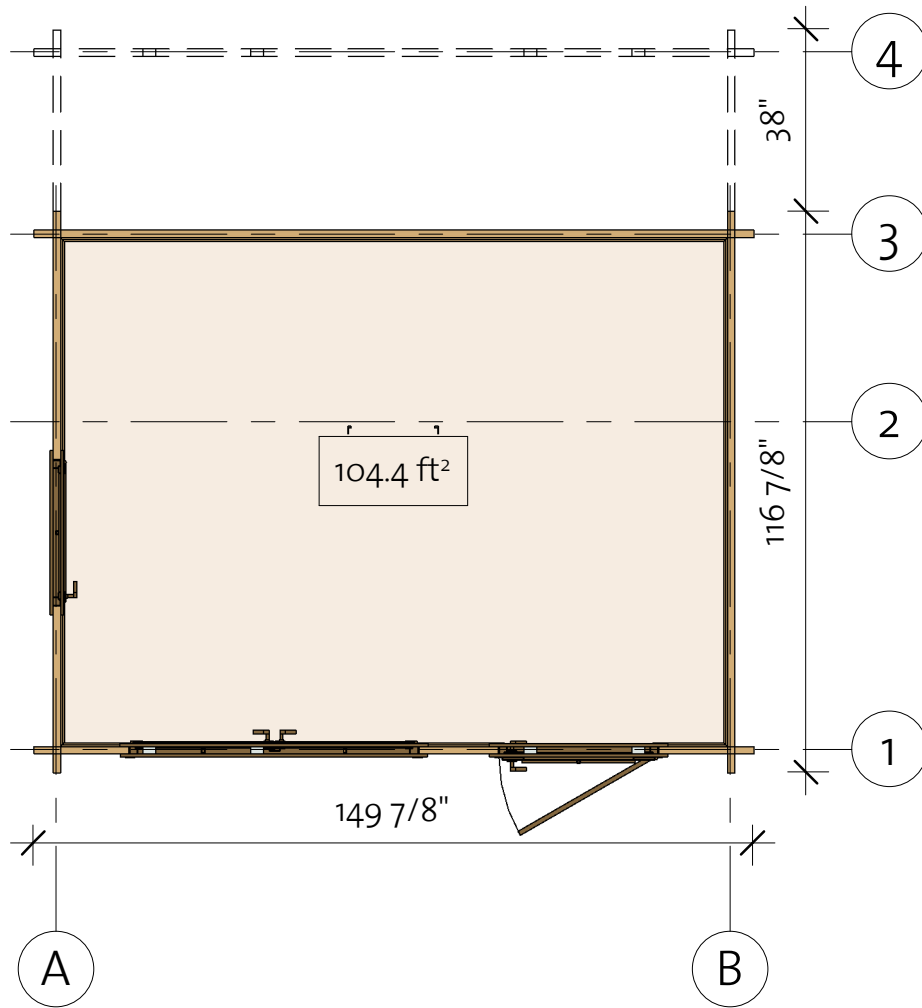
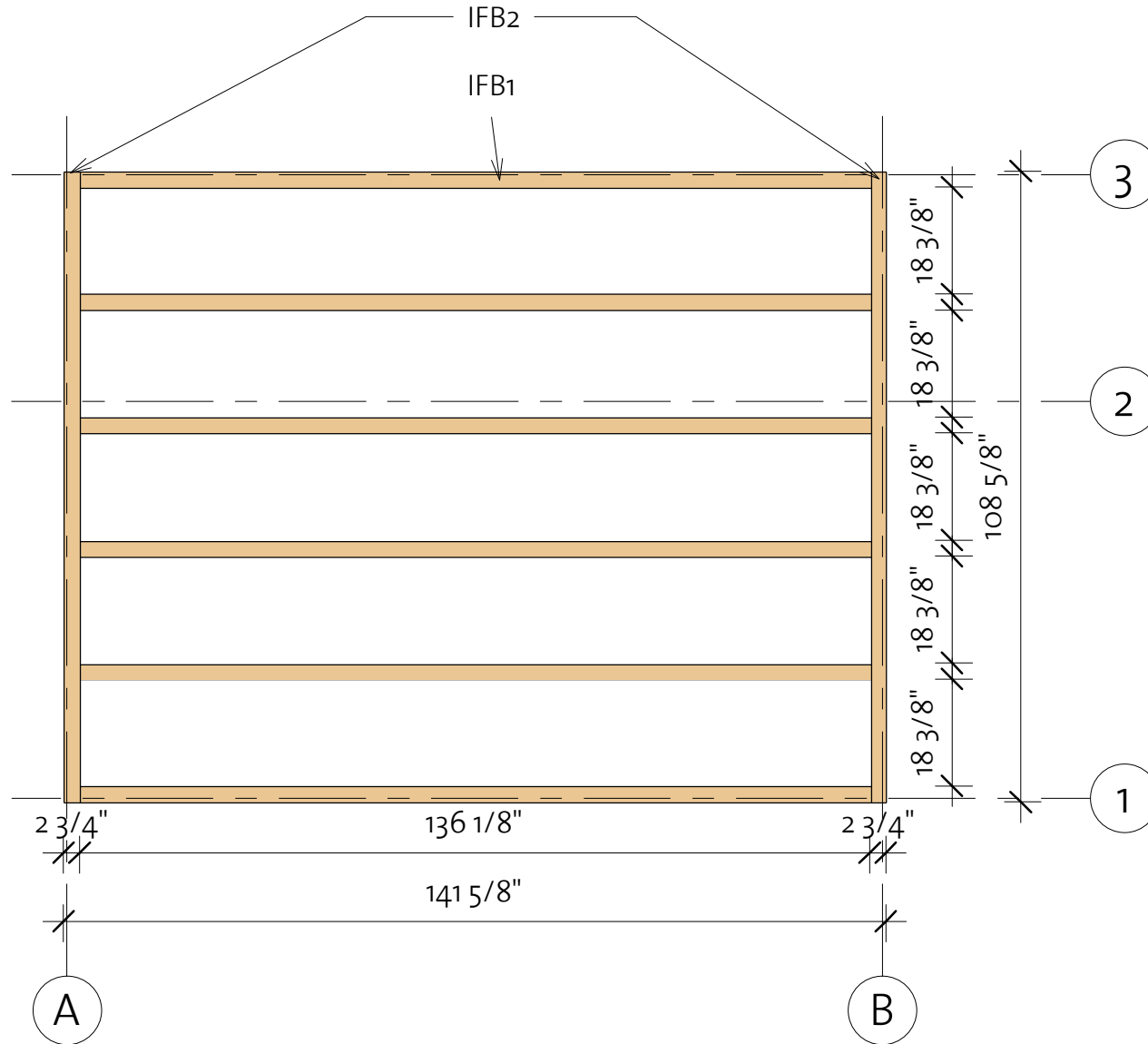

# Peacock Bunkie 40 (142"x109")

Foundation



Impregnated foundation beams				
Mark	Type	Profile	Count	Length

IFB1	IFB 40x70		6	136 1/8"
IFB2	IFB 40x70		2	108 5/8"

# Peacock Bunkie 40 (142"x109")

Floor Plan

① Baseboard

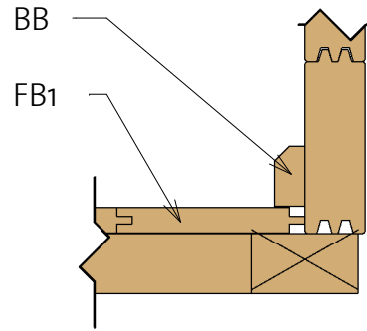

Floor Schedule				
Mark	Type	Profile	Count	Length
FB1	FB 17x114		32	105 3/4"
FB2	FB 17x114		32	77 1/8"
BB1	BB 20x40		2	77 3/16"
BB2	BB 20x40		2	109"
BB3	BB 20x40		3	141 3/4"

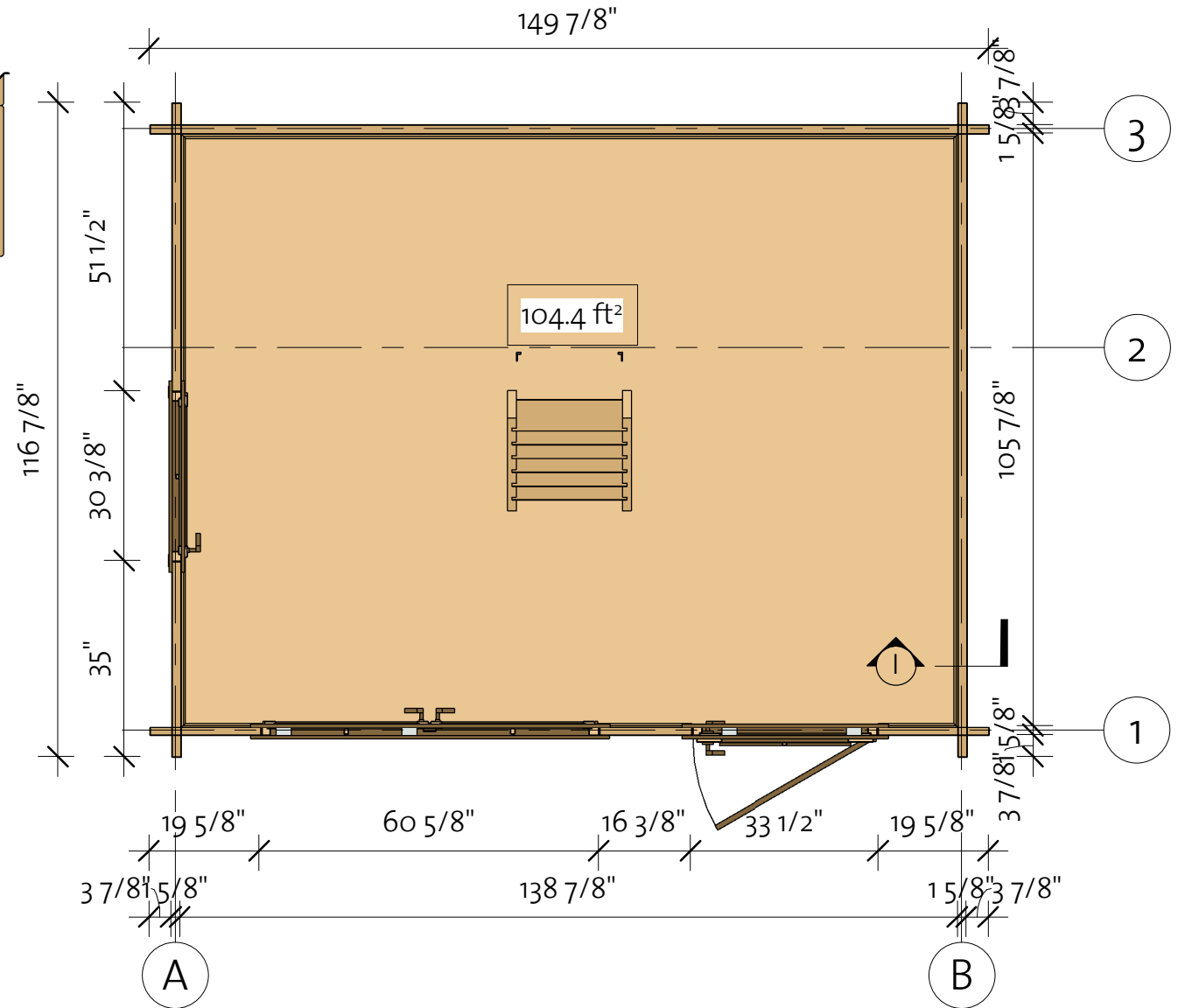

4200001\_210812

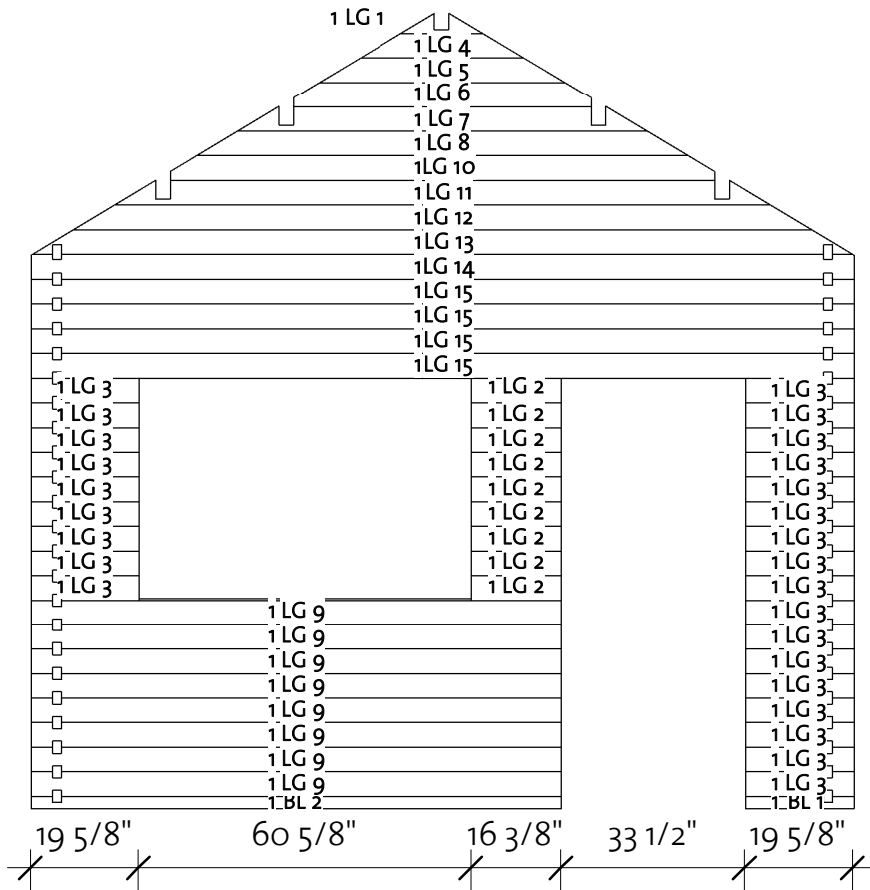
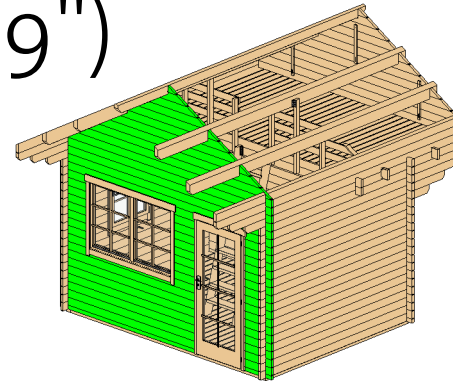

# Peacock Bunkie 40 (142"x109")

Wall 1



Log Profile Wall 1

Profile	Profile
---------	---------

40x57	
40x114	

Wall 1			
Mark	Profile	Count	Cut Length

1BL 1	40x57	1	19 5/8"
1BL 2	40x57	1	96 3/4"
1LG 1 *	40x114	1	14 7/8"
1LG 2	40x114	9	16 3/8"
1LG 3	40x114	26	19 5/8"
1LG 4 *	40x114	1	29 7/8"
1LG 5 *	40x114	1	44 7/8"
1LG 6 *	40x114	1	54 3/8"
1LG 7 *	40x114	1	74 3/4"
1LG 8 *	40x114	1	89 5/8"
1LG 9	40x114	8	96 3/4"
1LG 10 *	40x114	1	99 1/4"
1LG 11 *	40x114	1	119 5/8"
1LG 12 *	40x114	1	134 1/2"
1LG 13 *	40x114	1	149 1/2"
1LG 14 *	40x114	1	149 7/8"
1LG 15	40x114	4	149 7/8"

\* Gable - delivered premounted

# Peacock Bunkie 40 (142"x109")

Wall 2

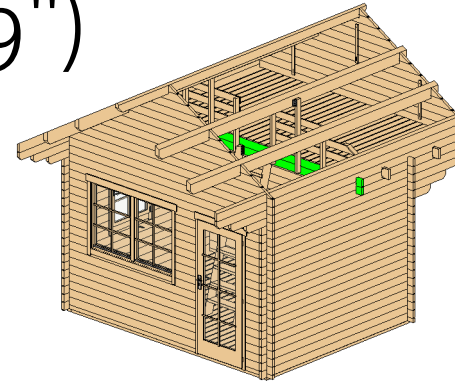

Wall 2			
Mark	Profile	Count	Cut Length

2LG-1	4OX114	1	149 7/8"
2TL-1	4OX114	1	149 7/8"

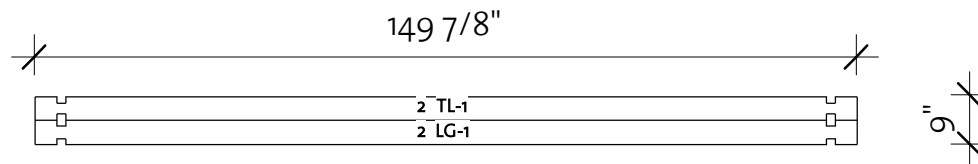

Log Profile Wall 2	
Profile	Profile

4OX114	
4OX114	

# Peacock Bunkie 40 (142"x109")

Wall 3

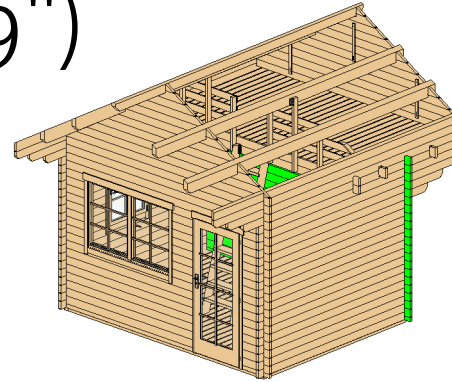

Wall 3			
Mark	Profile	Count	Cut Length

3BL 1	40X57	1	149 7/8"
3LG 1	40X114	19	149 7/8"
3TL 1	40X114	1	149 7/8"

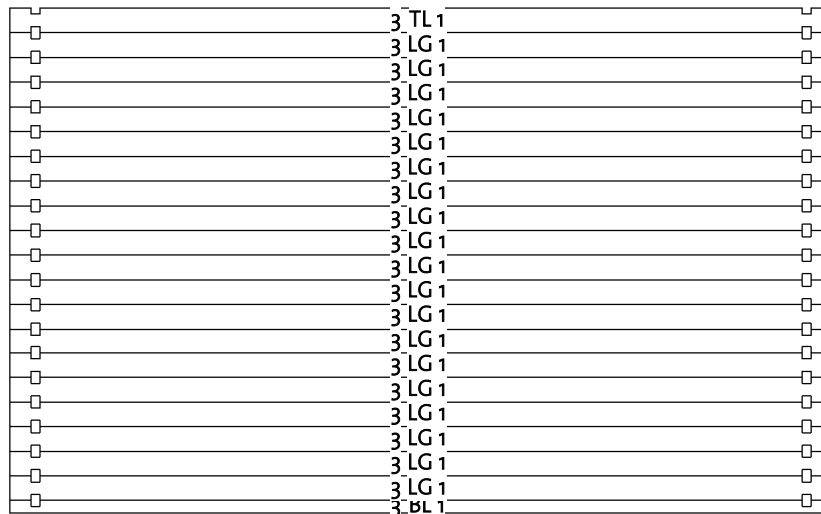

149 7/8"

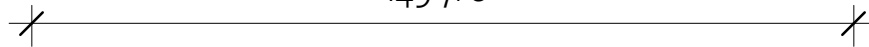

Log Profile Wall 3	
Profile	Profile

40X57	
40X114	
40X114	

# Peacock Bunkie 40 (142"x109")

Wall 4

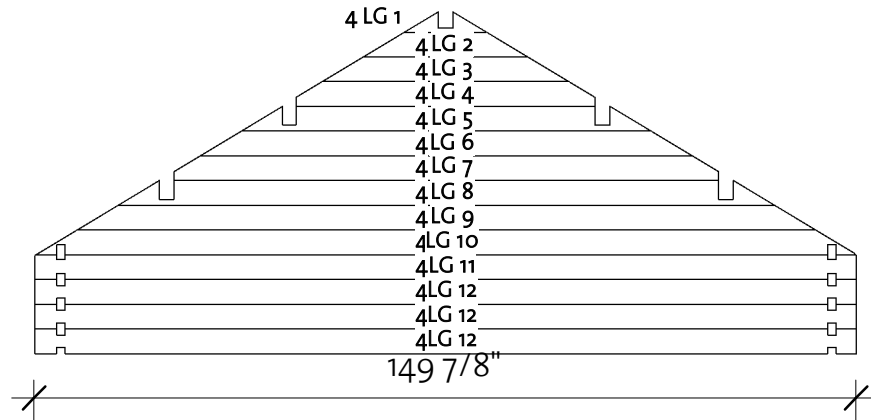
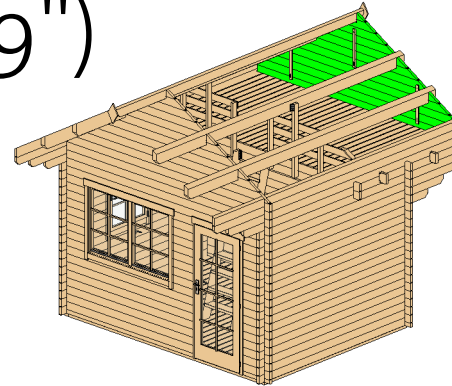

Wall 4			
Mark	Profile	Count	Cut Length

4LG 1 *	40X114	1	14 7/8"
4LG 2 *	40X114	1	29 7/8"
4LG 3 *	40X114	1	44 7/8"
4LG 4 *	40X114	1	54 3/8"
4LG 5 *	40X114	1	74 3/4"
4LG 6 *	40X114	1	89 5/8"
4LG 7 *	40X114	1	99 1/4"
4LG 8 *	40X114	1	119 5/8"
4LG 9 *	40X114	1	134 1/2"
4LG 10*	40X114	1	149 1/2"
4LG 11*	40X114	1	149 7/8"
4LG 12	40X114	3	149 7/8"

\* Gable - delivered premounted

Log Profile Wall 4	
Profile	Profile

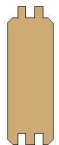
40X114	
--------	---

# Peacock Bunkie 40 (142"x109")

Wall A

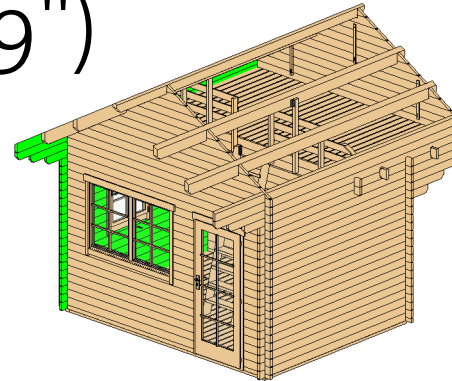

Wall A			
Mark	Profile	Count	Cut Length

ALG 1	40x114	9	35"
ALG 2	40x114	7	51 1/2"
ALG 3	40x114	1	63 3/8"
ALG 4	40x114	8	116 7/8"
ALG 5	40x114	1	75 1/8"
ALG 6	40x114	1	154 7/8"
ALG 7	40x114	1	166 3/4"
ALG 8	40x114	1	178 1/2"
ALG 9	40x114	1	189"
ALG 10	40x114	1	154 7/8"
ATL 1	40x138	1	189"

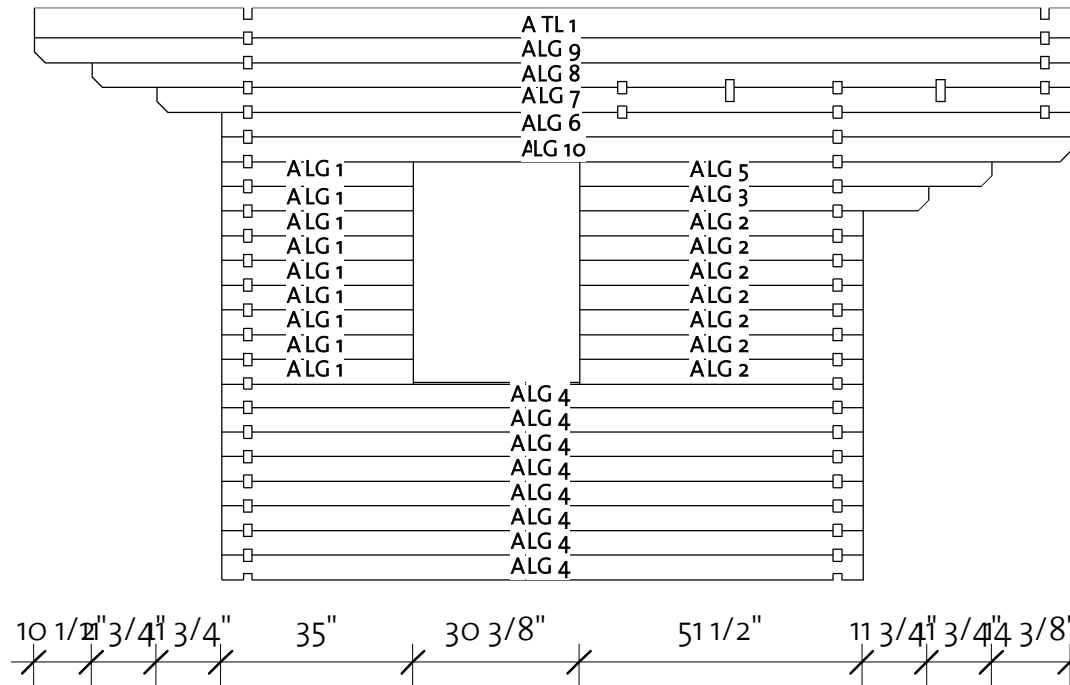

Log Profile Wall A	
Profile	Profile

40x114	
40x138	



# Peacock Bunkie 40 (142"x109")

Wall B

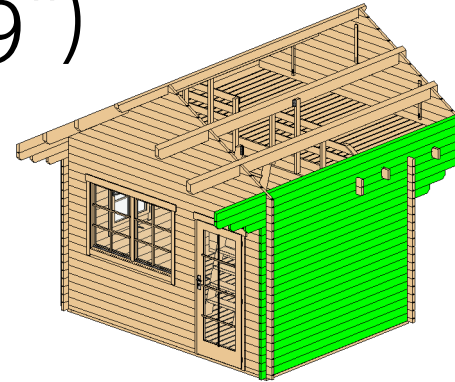

Wall B			
Mark	Profile	Count	Cut Length

B LG 1	40x114	15	116 7/8"
B LG 2	40x114	1	128 3/4"
B LG 3	40x114	1	140 1/2"
B LG 4	40x114	1	154 7/8"
B LG 5	40x114	1	154 7/8"
B LG 6	40x114	1	166 3/4"
B LG 7	40x114	1	178 1/2"
B LG 8	40x114	1	189"
B TL 1	40x138	1	189"

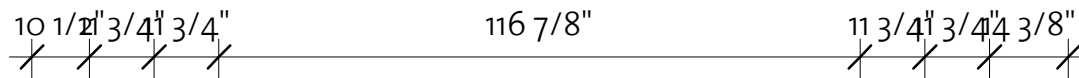
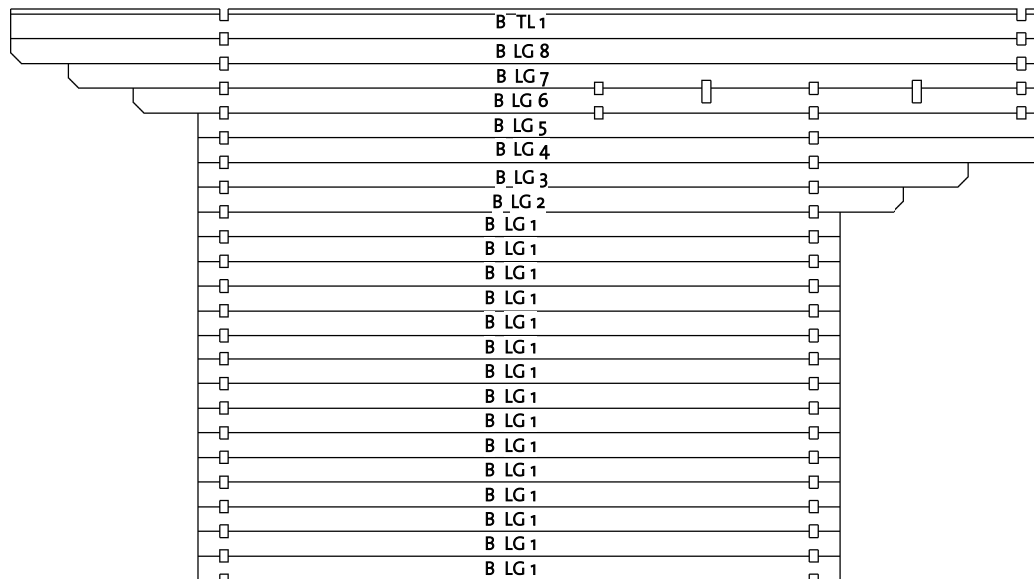

Log Profile Wall B	
Profile	Profile

40x114	
40x138	

# Peacock Bunkie 40 (142"x109")

Second floor

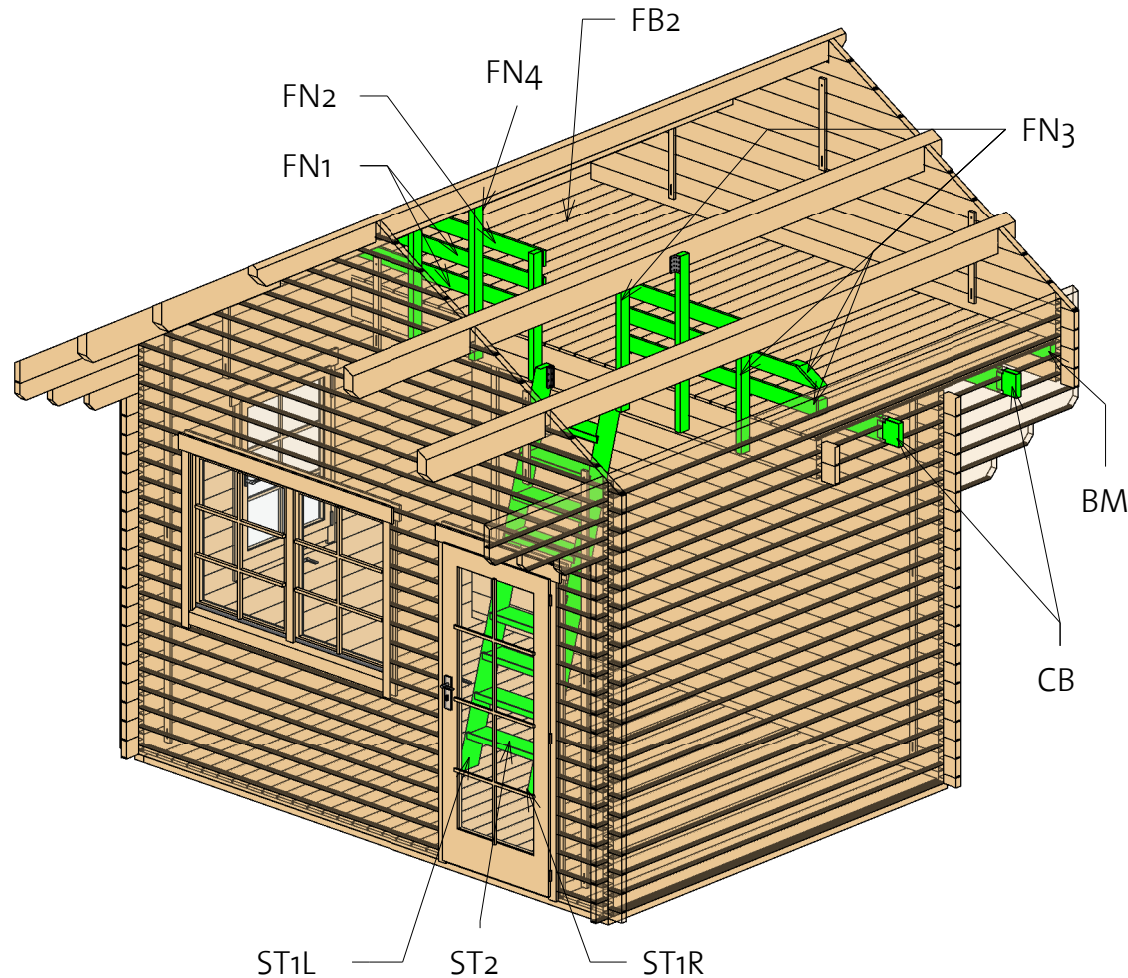

\* Stair location can be chosen, Fence details supplied in full length, recommended installation method shown in the assembly guide.

4200001\_210812

Second floor				
Mark	Type	Profile	Count	Cut Length
BM	Beam 40x90		1	138 7/8"
CB	Ceiling beam 40x143		2	149 7/8"
FN1	Fence1 18x95		2	141 3/4"
FN2	Fence2 18x95		1	102 3/8"
FN3	Fence3 40x70		5	30"
FN4	Fence4 40x70		2	41 1/2"
ST1L	Stair 40x120 L		1	91 7/8"
ST1R	Stair 40x120 R		1	91 7/8"
ST2	Stair 40x143		9	20 1/2"

# Peacock Bunkie 40 (142"x109")

Fence

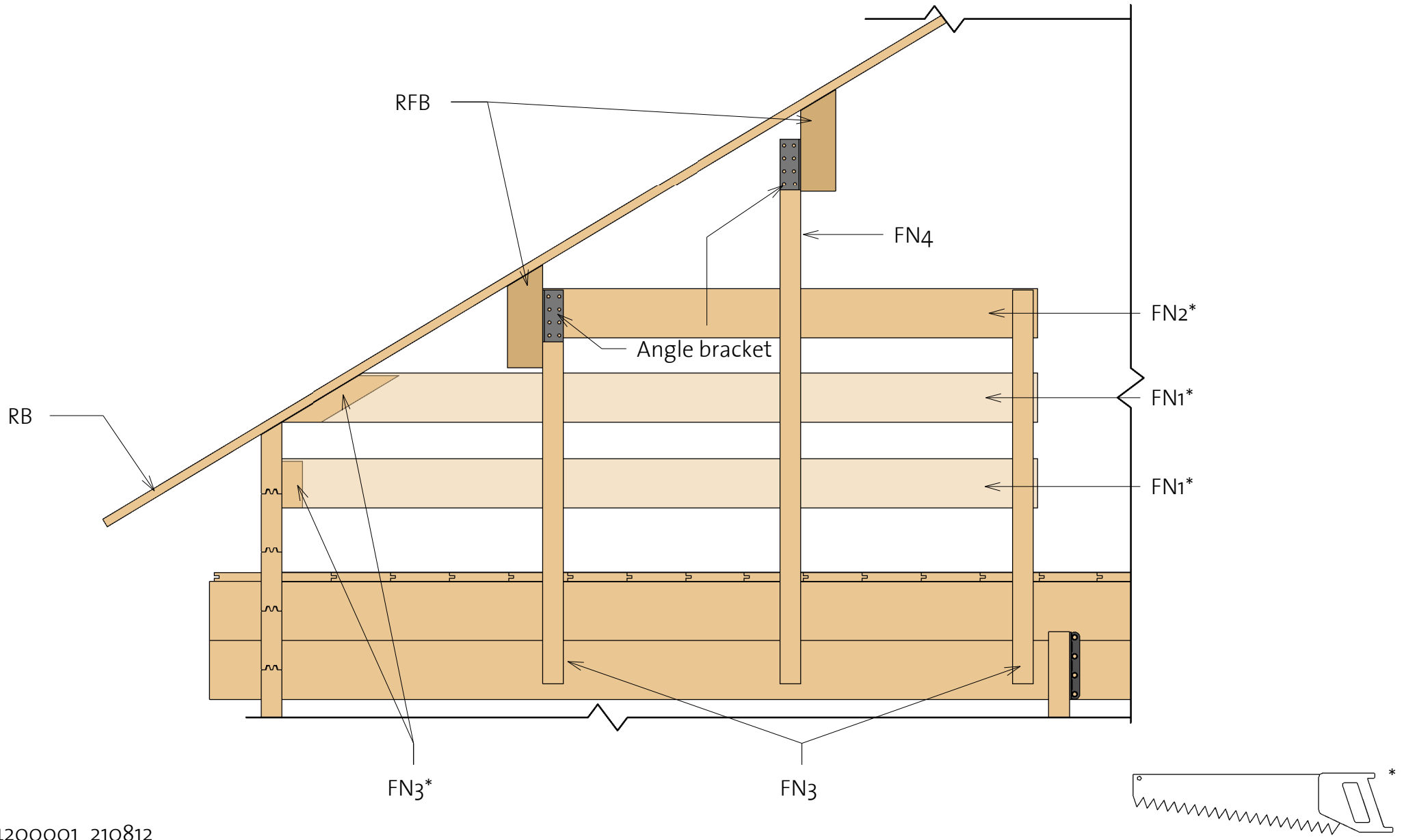

# Peacock Bunkie 40 (142"x109")

Stair

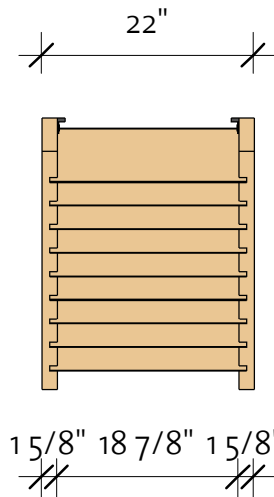
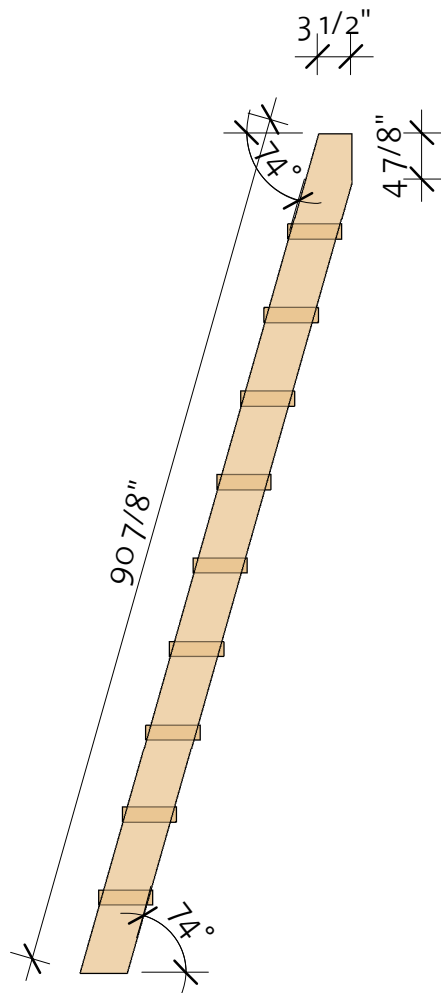
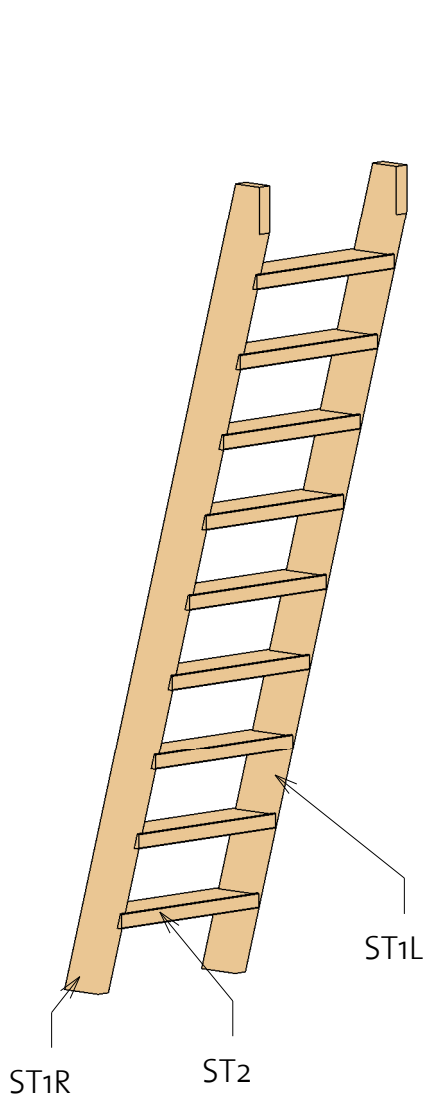

Stair				
Mark	Profile	Profile	Count	Cut Length
ST1L	Stair 40X120		1	91 7/8"
ST1R	Stair 40X120		1	91 7/8"
ST2	Stair 40X143		9	20 1/2"

# Peacock Bunkie 40 (142"x109")

Roof 1

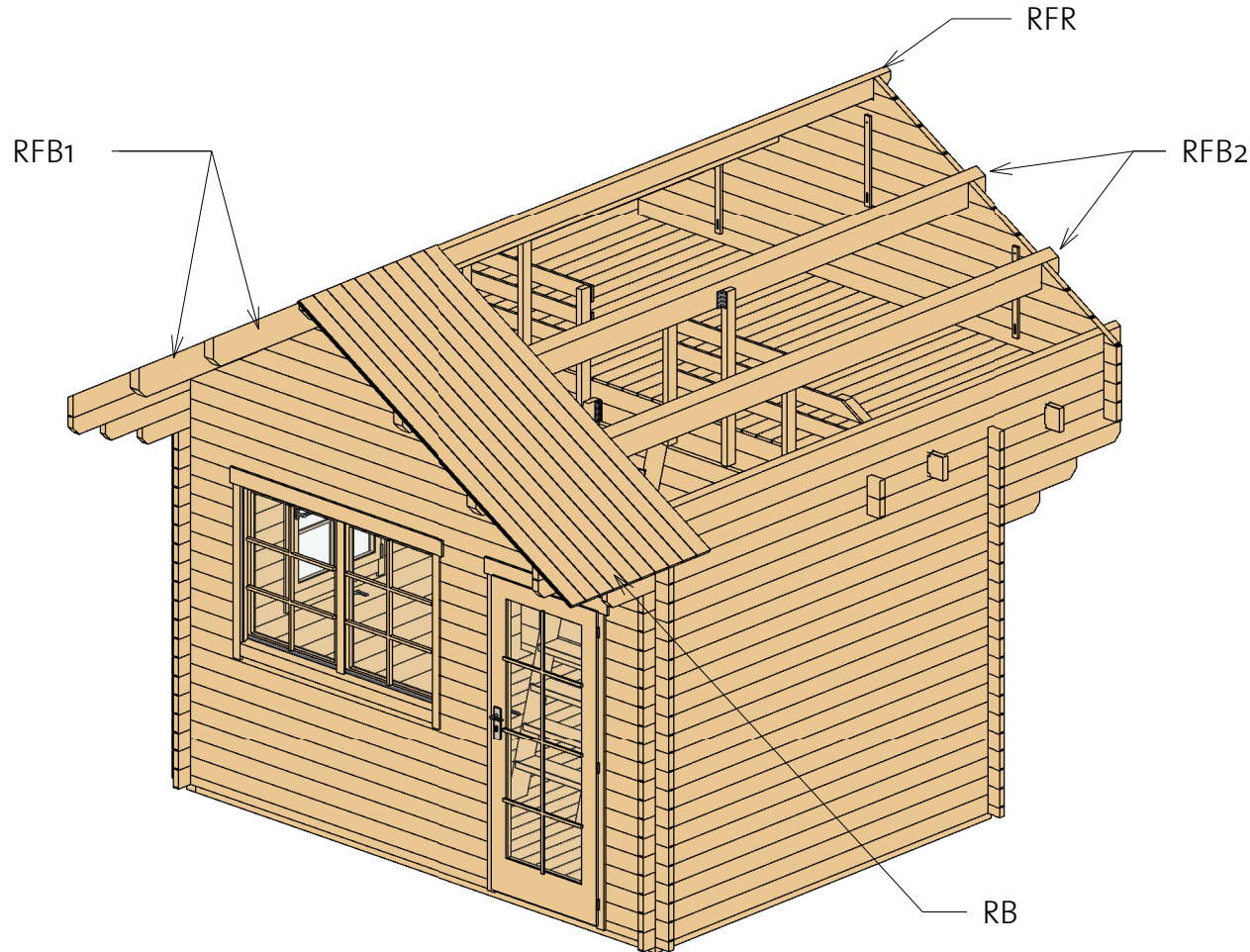

Roof				
Mark	Type	Profile	Count	Length
RFR	Ridge 68x143		1	189"
RFB1	Beam 68x193		2	189"
RFB2	Beam 68x193		2	189"
RB	17x114		86	96 1/2"

# Peacock Bunkie 40 (142"x109")

Roof 2

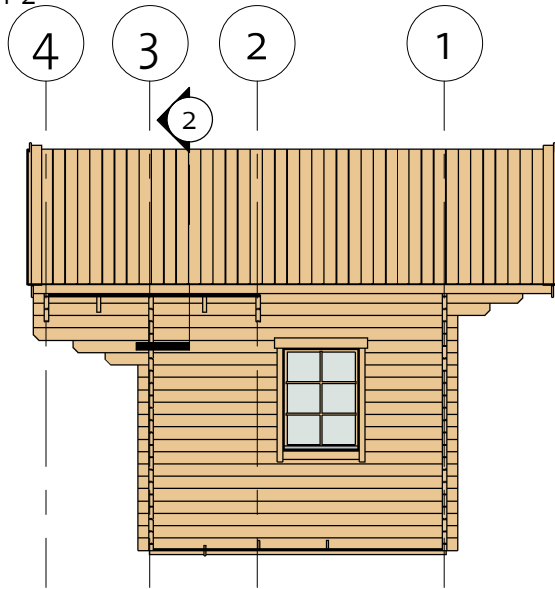

② Facia

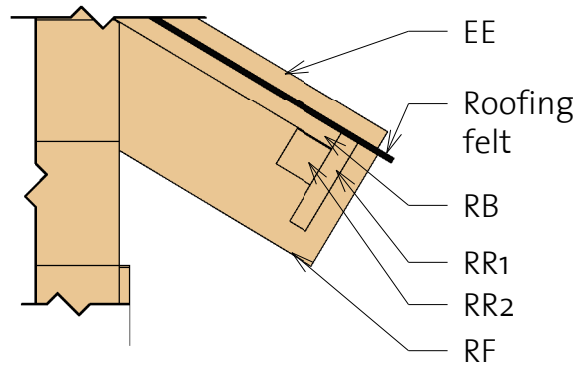

③ Roof Reinforcement

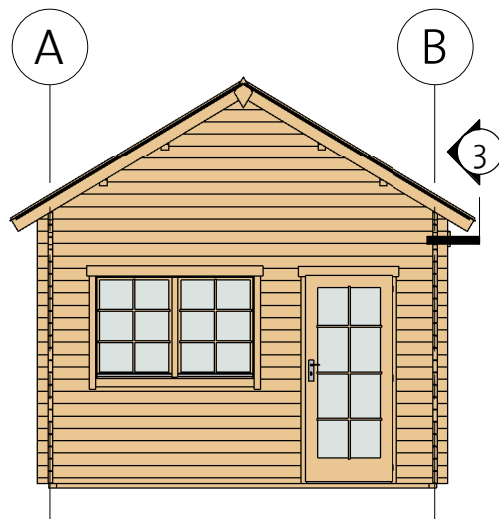
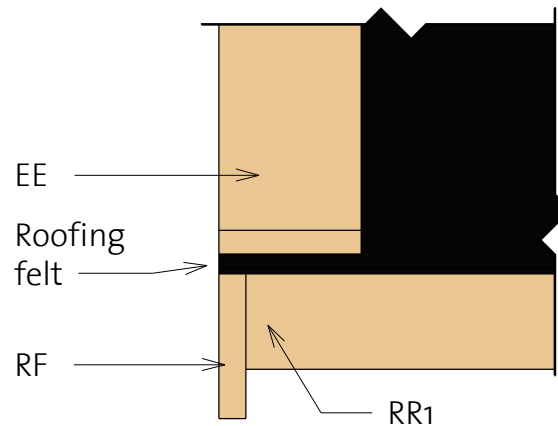

Fascia Schedule

Mark	Type	Profile	Count	Length
EE	Eave Edging 18x95		4	98 3/8"
RF	Roof Fascia 18x120		4	98 3/8"
RR1	Roof reinforcement 18x95		2	189"
RR2	Roof reinforcement 38x38		2	189"

# Peacock Bunkie 40 (142"x109")

Extras

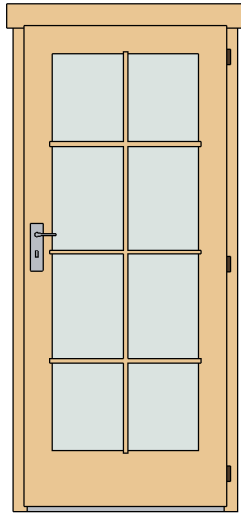

Door Schedule				
Model	Type	Width	Height	Count

CD6R	Classic door 6 right	33 1/8"	77"	1
------	----------------------	---------	-----	---

DCB8	Door Crossbar 8	--	--	0"
------	-----------------	----	----	----

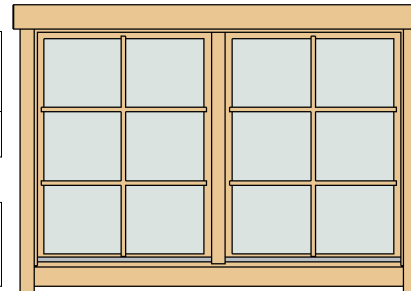

Window Schedule				
Model	Type	Width	Height	Count

CDW1	Classic double window 1	60 1/4"	39"	1
------	-------------------------	---------	-----	---

CW1R	Classic window 1 right	30 1/8"	39"	1
------	------------------------	---------	-----	---

WCB6	Windows Crossbar 6	--	--	3
------	--------------------	----	----	---

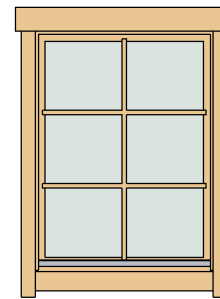

Fasteners/Extras		
Name	Type	Count

Hitblock	300-400 mm	
Ladder fittings		2
Angle bracket	30x40x100	4
Bolts	M8 x 70	24
Screws	5,0 x 40	24
Screws	5,0 x 70	60
Nails	1,4 x 40	60
Screws	6,0 x 140	90
Screws	4,0 x 40	1030

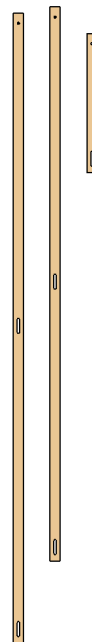

Type	Count	Length
------	-------	--------

Windboard 1 18x40	2	98 3/8"
Windboard 2 18x40	2	86 5/8"
Windboard 3 18x40	6	21 5/8"

Family	Count
--------	-------

Romb	2
------	---





# Peacock Bunkie 40 (142"x109")

## List of all items 1



### Impregnated foundation beams

Mark	Type	Profile	Count	Length
------	------	---------	-------	--------

IFB1	IFB 40x70		6	136 1/8"
IFB2	IFB 40x70		2	108 5/8"





### Floor Schedule

Mark	Type	Profile	Count	Length
------	------	---------	-------	--------

FB1	FB 17x114		32	105 3/4"
FB2	FB 17x114		32	77 1/8"
BB1	BB 20x40		2	77 3/16"
BB2	BB 20x40		2	109"
BB3	BB 20x40		3	141 3/4"





### Roof

Mark	Type	Profile	Count	Length
------	------	---------	-------	--------

RFR	Ridge 68x143		1	189"
RFB1	Beam 68x193		2	189"
RFB2	Beam 68x193		2	189"
RB	17x114		86	96 1/2"

### Fascia Schedule

Mark	Type	Profile	Count	Length
------	------	---------	-------	--------

EE	Eave Edging 18x95		4	98 3/8"
RF	Roof Fascia 18x120		4	98 3/8"
RR1	Roof reinforcement 18x95		2	189"
RR2	Roof reinforcement 38x38		2	189"



# Peacock Bunkie 40 (142"x109")

## List of all items 2

Wall 1			
Mark	Profile	Count	Cut Length

1BL 1	40X57	1	19 5/8"
1BL 2	40X57	1	96 3/4"
1LG 1 *	40X114	1	14 7/8"
1LG 2	40X114	9	16 3/8"
1LG 3	40X114	26	19 5/8"
1LG 4 *	40X114	1	29 7/8"
1LG 5 *	40X114	1	44 7/8"
1LG 6 *	40X114	1	54 3/8"
1LG 7 *	40X114	1	74 3/4"
1LG 8 *	40X114	1	89 5/8"
1LG 9	40X114	8	96 3/4"
1LG 10*	40X114	1	99 1/4"
1LG 11 *	40X114	1	119 5/8"
1LG 12*	40X114	1	134 1/2"
1LG 13*	40X114	1	149 1/2"
1LG 14*	40X114	1	149 7/8"
1LG 15	40X114	4	149 7/8"

\* Gable - delivered premounted



Wall 2			
Mark	Profile	Count	Cut Length

2LG-1	40X114	1	149 7/8"
2TL-1	40X114	1	149 7/8"

Wall 3			
Mark	Profile	Count	Cut Length

3BL 1	40X57	1	149 7/8"
3LG 1	40X114	19	149 7/8"
3TL 1	40X114	1	149 7/8"

Log Profiles 1	
Profile	Profile

40X57	
40X114	

Log Profiles 1	
Profile	Profile

40X114	
--------	---

# Peacock Bunkie 40 (142"x109")

## List of all items 3

Wall 4			
Mark	Profile	Count	Cut Length

4LG 1 *	40X114	1	14 7/8"
4LG 2 *	40X114	1	29 7/8"
4LG 3 *	40X114	1	44 7/8"
4LG 4 *	40X114	1	54 3/8"
4LG 5 *	40X114	1	74 3/4"
4LG 6 *	40X114	1	89 5/8"
4LG 7 *	40X114	1	99 1/4"
4LG 8 *	40X114	1	119 5/8"
4LG 9 *	40X114	1	134 1/2"
4LG 10 *	40X114	1	149 1/2"
4LG 11 *	40X114	1	149 7/8"
4LG 12	40X114	3	149 7/8"

\* Gable - delivered premounted

Log Profiles 2	
Profile	Profile

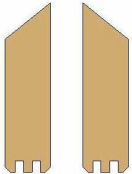
40X114	
40X138	

Wall A			
Mark	Profile	Count	Cut Length

ALG 1	40X114	9	35"
ALG 2	40X114	7	51 1/2"
ALG 3	40X114	1	63 3/8"
ALG 4	40X114	8	116 7/8"
ALG 5	40X114	1	75 1/8"
ALG 6	40X114	1	154 7/8"
ALG 7	40X114	1	166 3/4"
ALG 8	40X114	1	178 1/2"
ALG 9	40X114	1	189"
ALG 10	40X114	1	154 7/8"
ATL 1	40X138	1	189"









Wall B			
Mark	Profile	Count	Cut Length

BLG 1	40X114	15	116 7/8"
BLG 2	40X114	1	128 3/4"
BLG 3	40X114	1	140 1/2"
BLG 4	40X114	1	154 7/8"
BLG 5	40X114	1	154 7/8"
BLG 6	40X114	1	166 3/4"
BLG 7	40X114	1	178 1/2"
BLG 8	40X114	1	189"
BTL 1	40X138	1	189"



# Peacock Bunkie 40 (142"x109")

## List of all items 4

Second floor				
Mark	Type	Profile	Count	Cut Length

BM	Beam 40x90		1	138 7/8"
CB	Ceiling beam 40x143		2	149 7/8"
FN1	Fence1 18x95		2	141 3/4"
FN2	Fence2 18x95		1	102 3/8"
FN3	Fence3 40x70		5	30"
FN4	Fence4 40x70		2	41 1/2"
ST1L	Stair 40x120 L		1	91 7/8"
ST1R	Stair 40x120 R		1	91 7/8"
ST2	Stair 40x143		9	20 1/2"

Stair				
Mark	Profile	Profile	Count	Cut Length

ST1L	Stair 40x120		1	91 7/8"
ST1R	Stair 40x120		1	91 7/8"
ST2	Stair 40x143		9	20 1/2"