

# Garage B 40 (177 1/8" x 216 1/2")

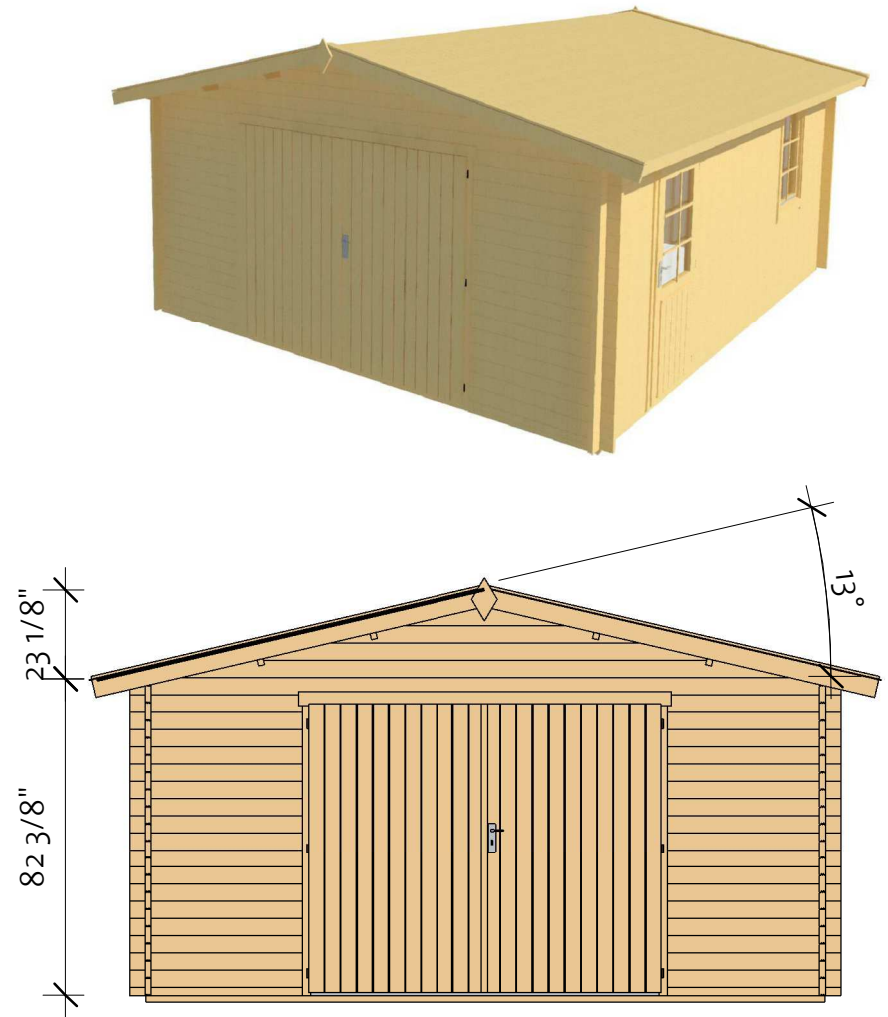
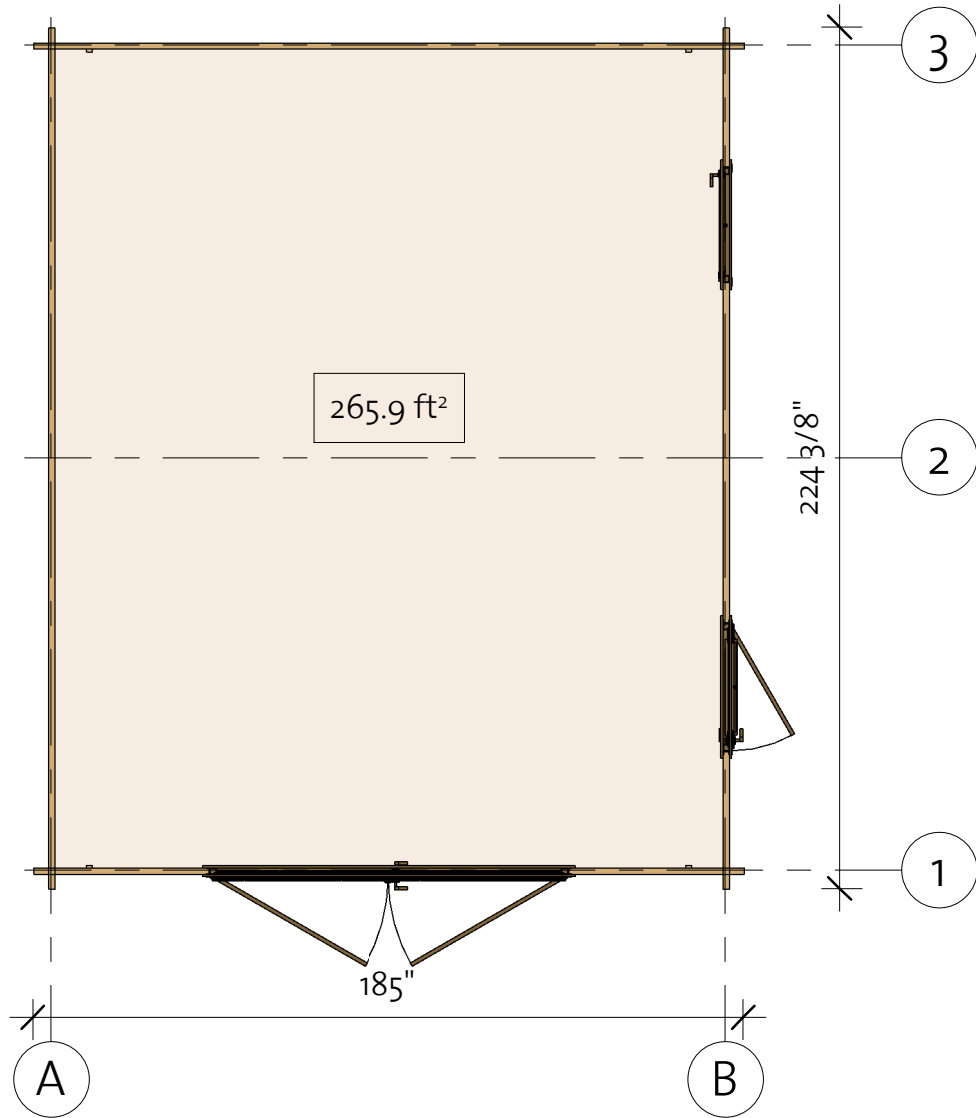

4400003\_230505

**EZ** Log Structures  
Do-It-Yourself Building Kits

# Garage B 40 (177 1/8" x 216 1/2")

Foundation

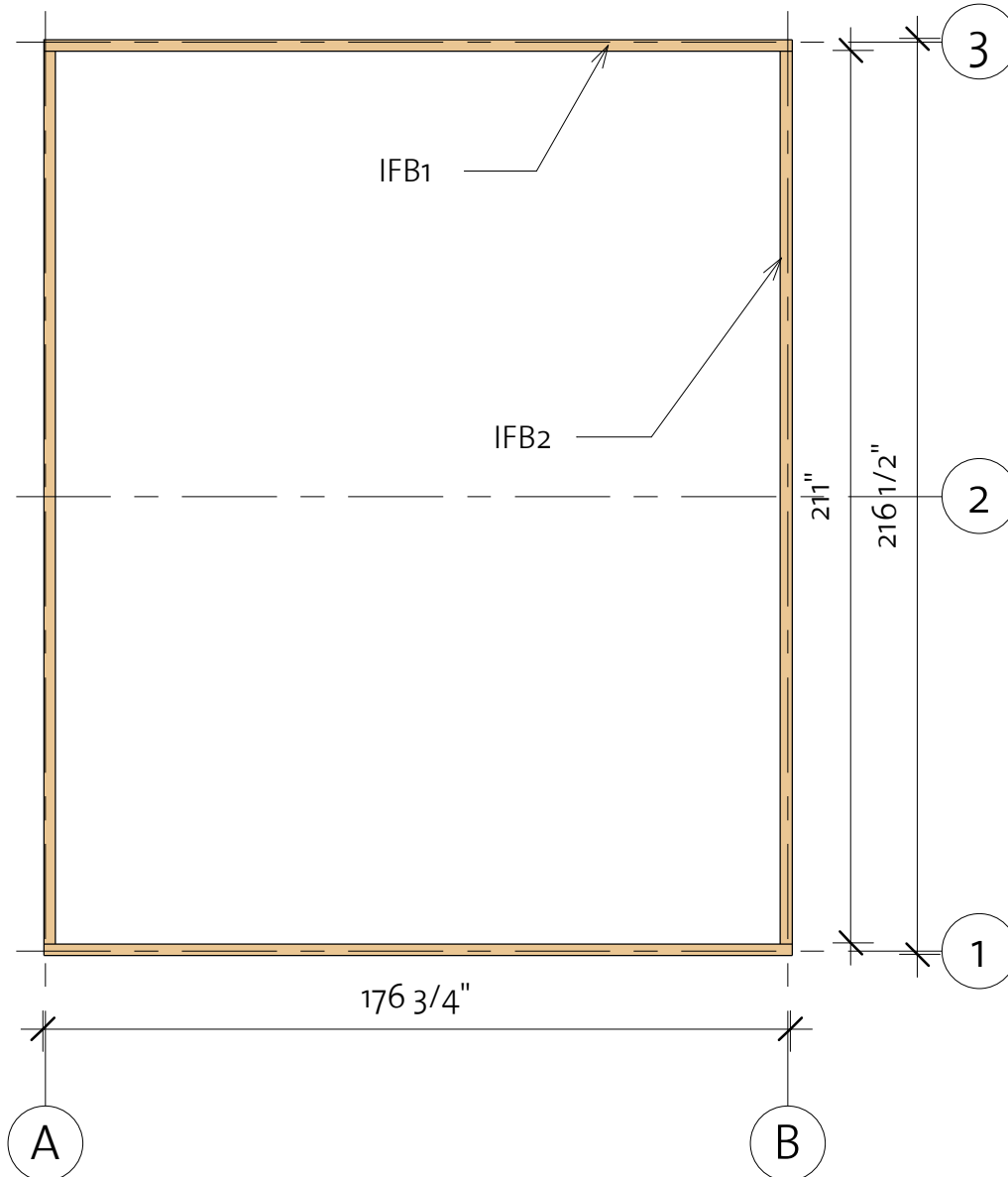

Impregnated foundation beams				
Mark	Type	Profile	Count	Length

IFB1	IFB 70x40		2	176 3/4"
IFB2	IFB 70x40		2	211"

# Garage B 40 (177 1/8" x 216 1/2") 185"

Floor Plan

① Foundation

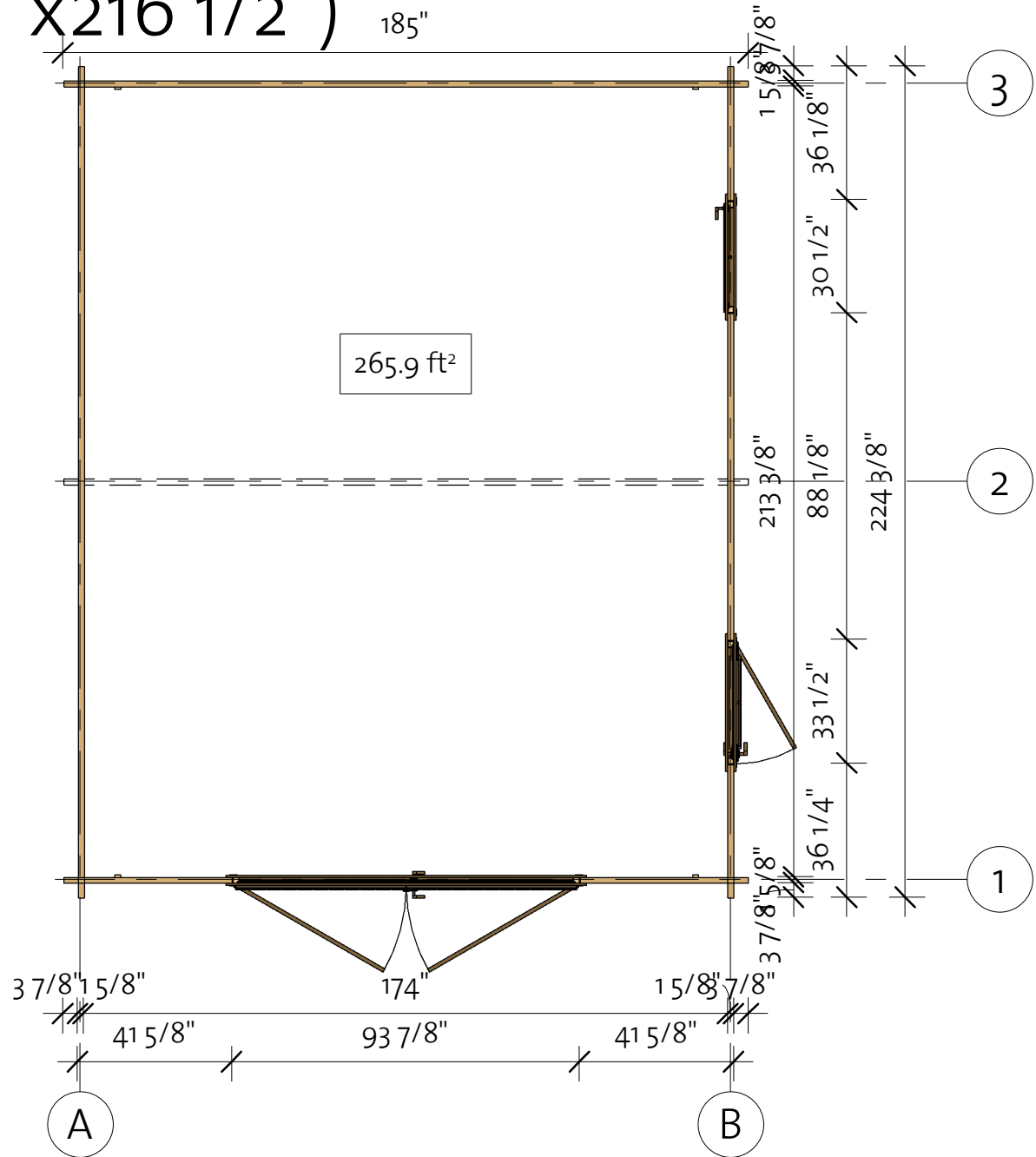
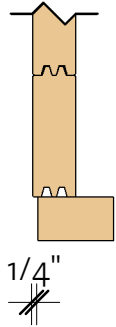

# Garage B 40 (177 1/8" x 216 1/2")

Wall 1

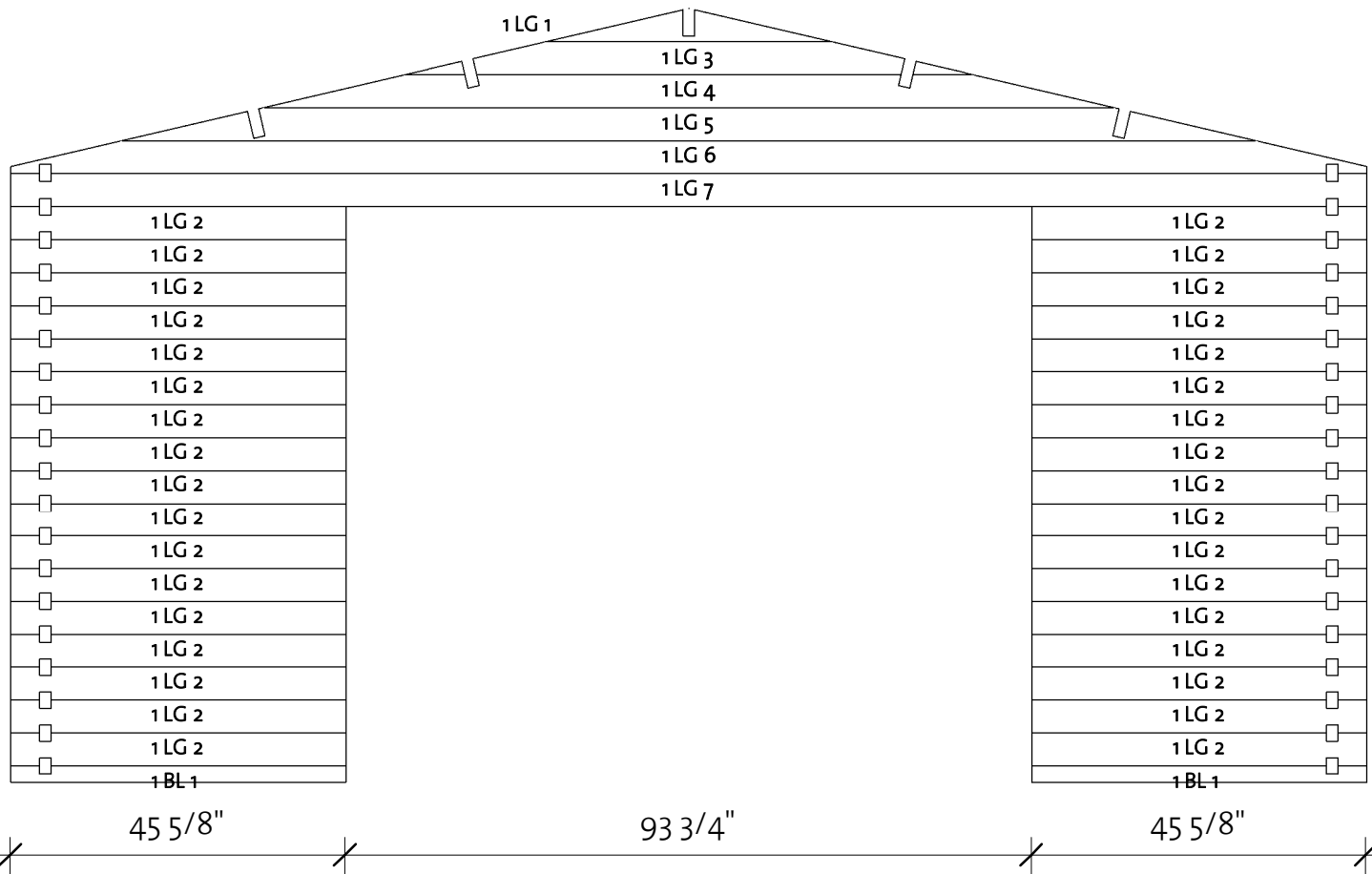
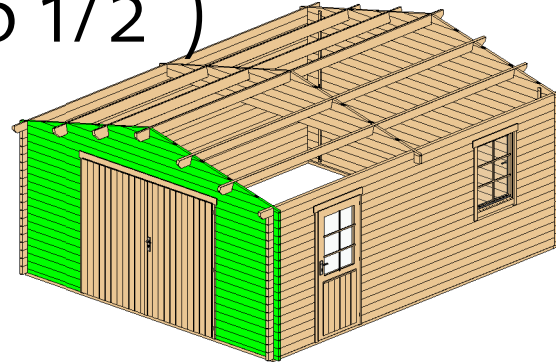



4400003\_230505

Wall 1			
Mark	Profile	Count	Cut Length

1BL 1	40X57	2	45 5/8"
1LG 1*	40X114	1	38 3/4"
1LG 2	40X114	34	45 5/8"
1LG 3*	40X114	1	77 3/8"
1LG 4*	40X114	1	116"
1LG 5*	40X114	1	154 5/8"
1LG 6*	40X114	1	185"
1LG 7	40X114	1	185"

\* Gable - delivered premounted

Log Profile Wall 1	
Profile	Profile

40X57	
40X114	

# Garage B 40 (177 1/8" x 216 1/2")

Wall 2

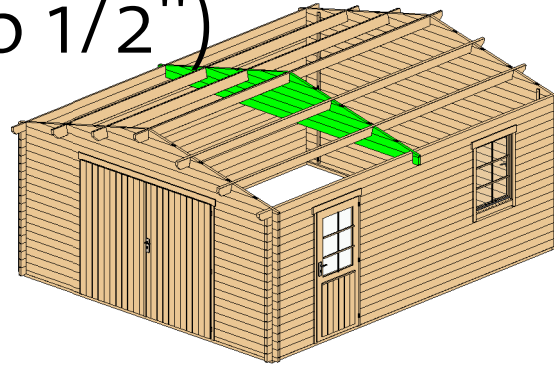

Wall 2			
Mark	Profile	Count	Cut Length

2LG 1*	40x114	1	38 3/4"
2LG 2*	40x114	1	77 3/8"
2LG 3*	40x114	1	116"
2LG 4*	40x114	1	154 5/8"
2LG 5*	40x114	1	185"
2LG 6	40x114	1	185"

\* Gable - delivered premounted

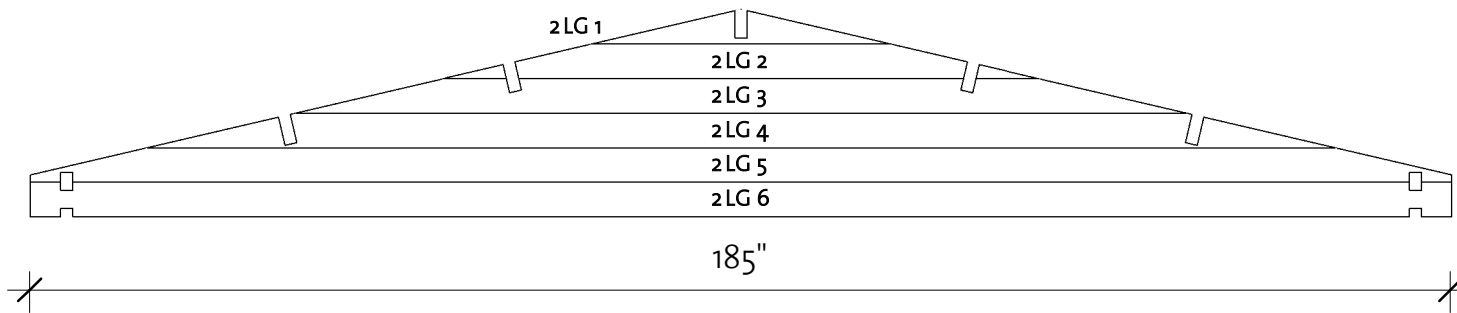

Log Profile Wall 2	
Profile	Profile

40x114	
--------	--

# Garage B 40 (177 1/8" x 216 1/2")

Wall 3

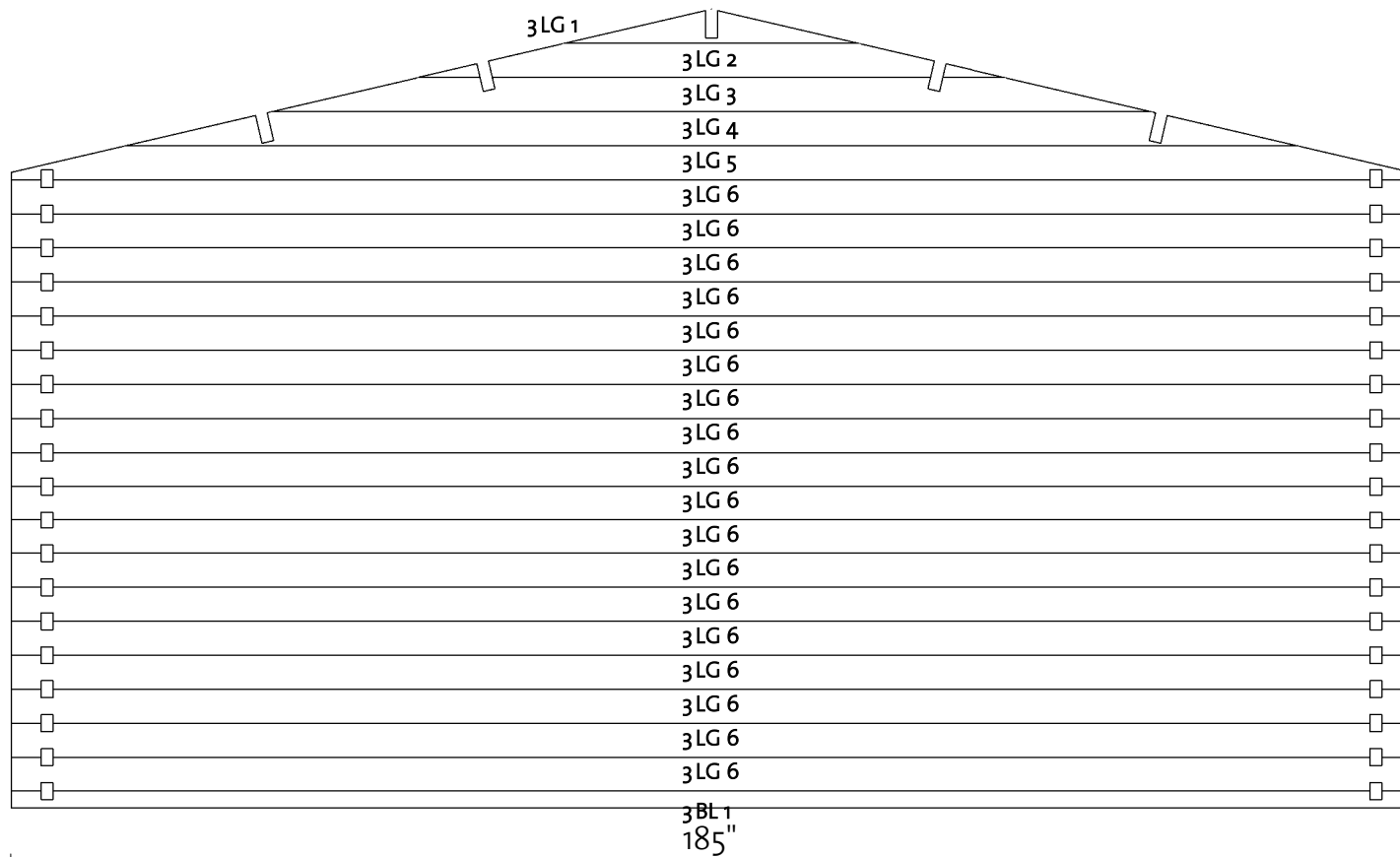
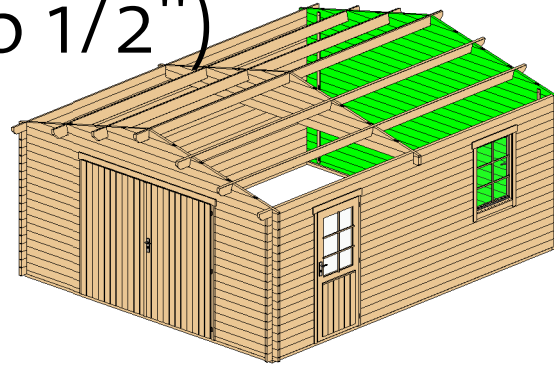

Wall 3			
Mark	Profile	Count	Cut Length

3BL 1	40X57	1	185"
3LG 1 *	40X114	1	38 3/4"
3LG 2 *	40X114	1	77 3/8"
3LG 3 *	40X114	1	116"
3LG 4 *	40X114	1	154 5/8"
3LG 5 *	40X114	1	185"
3LG 6	40X114	18	185"

\* Gable - delivered premounted

Log Profile Wall 3	
Profile	Profile

40X57	
40X114	



# Garage B 40 (177 1/8" x 216 1/2")

Wall B

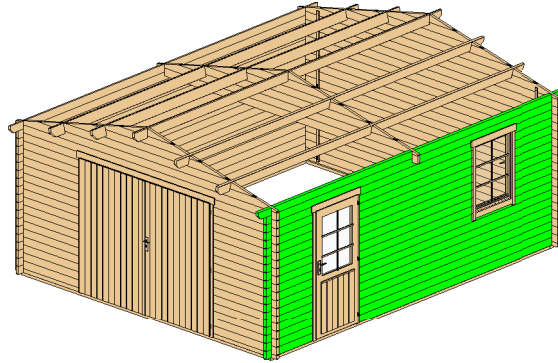

Wall B			
Mark	Profile	Count	Cut Length
BLG 1	40X114	8	154 3/4"
BLG 2	40X114	26	36 1/4"
BLG 3	40X114	9	88 1/4"
BLG 4	40X114	1	224 3/8"
BTL 1	40X114	1	234 1/4"

Log Profile Wall B	
Profile	Profile
40X114	
40X114	

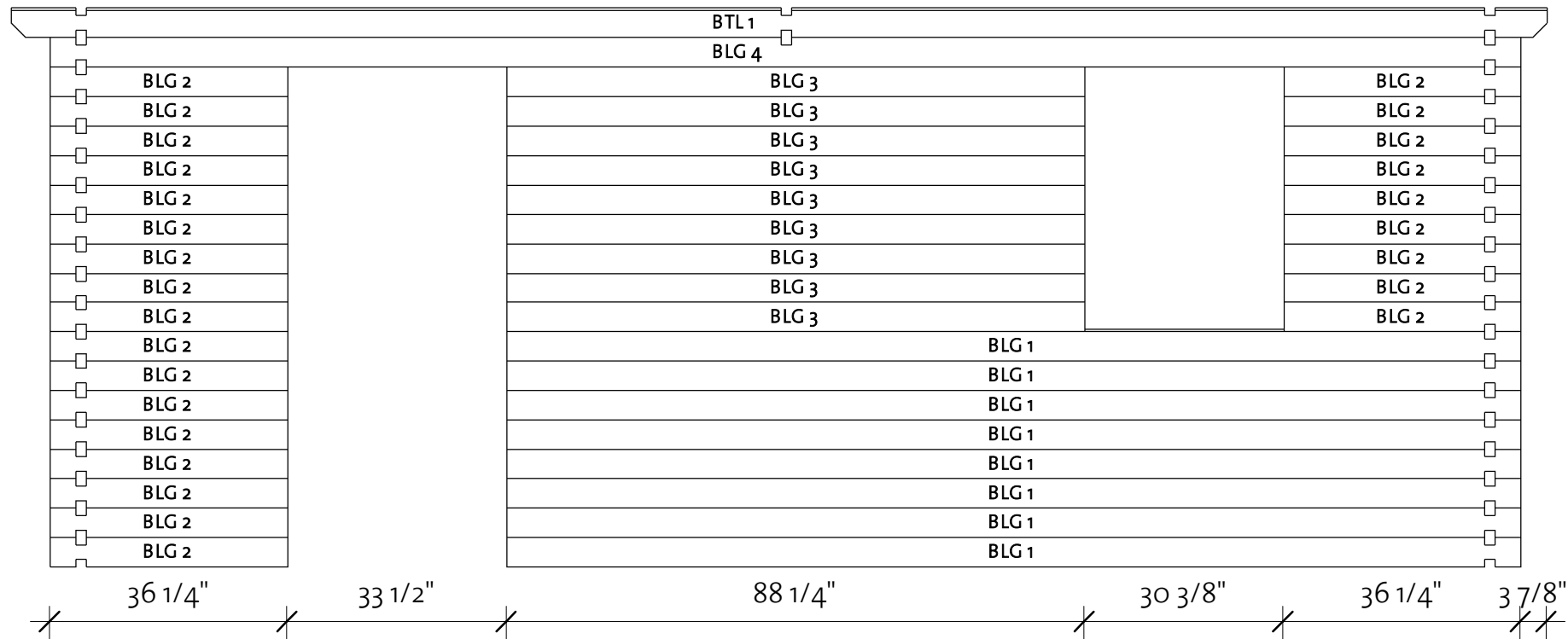



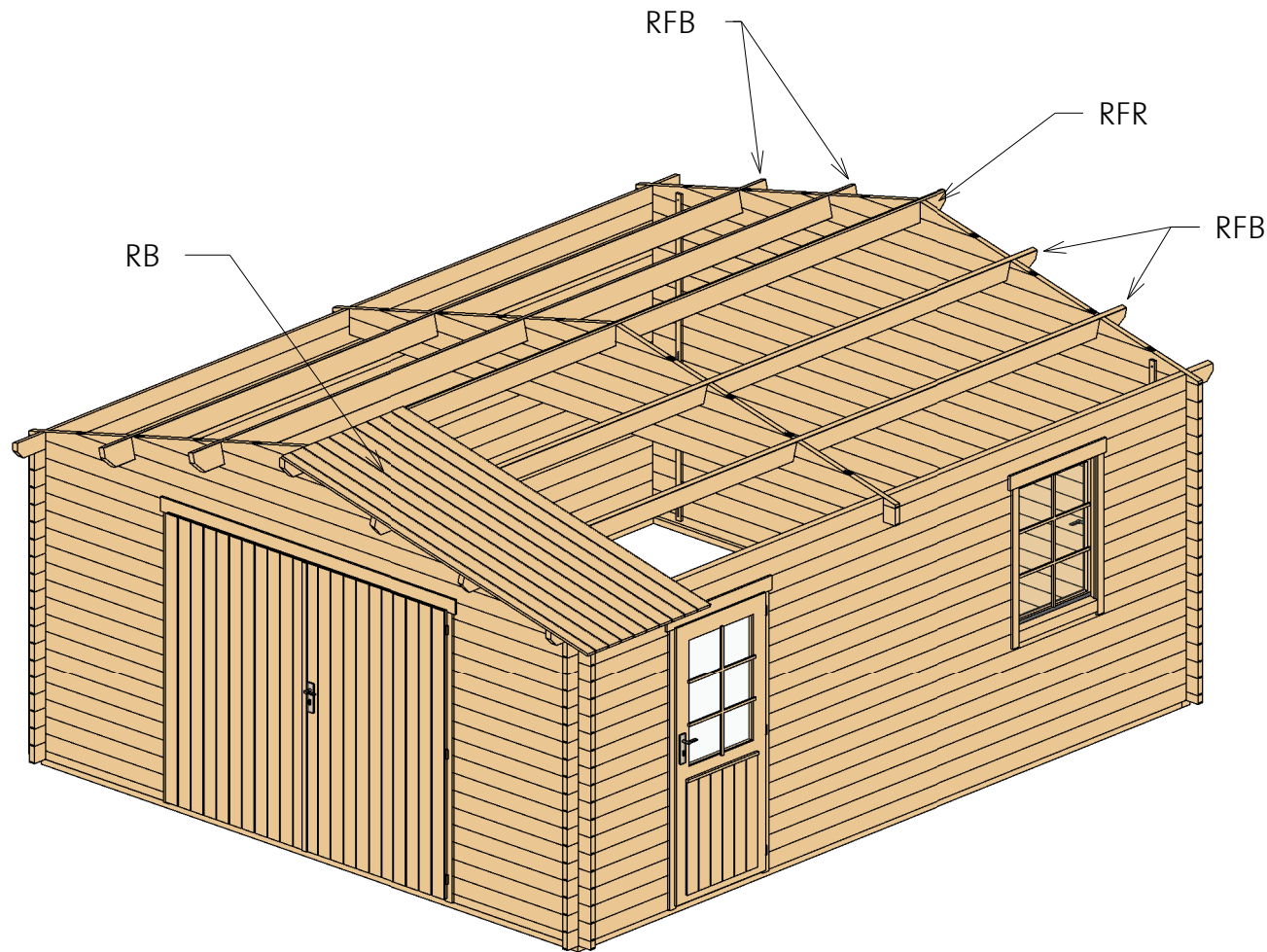

# Garage B 40 (177 1/8" x 216 1/2")

Roof 1



Roof				
Mark	Type	Profile	Count	Length
RFR	Ridge 40x143		1	234 1/4"
RFB	Beam 40x143		4	234 1/4"
RB	17x114		108	103 5/8"

# Garage B 40 (177 1/8" x 216 1/2")

Roof 2

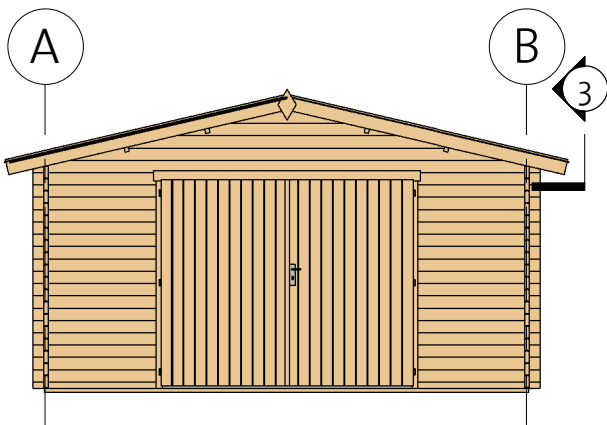
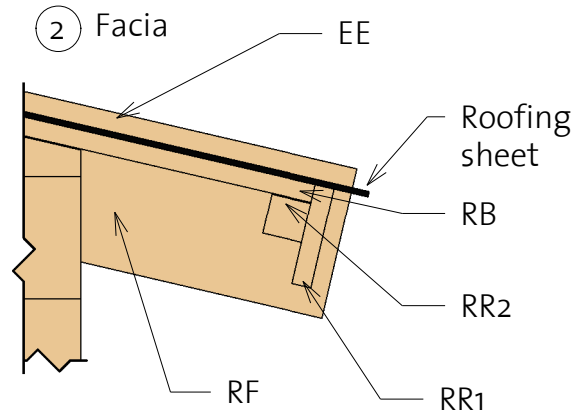
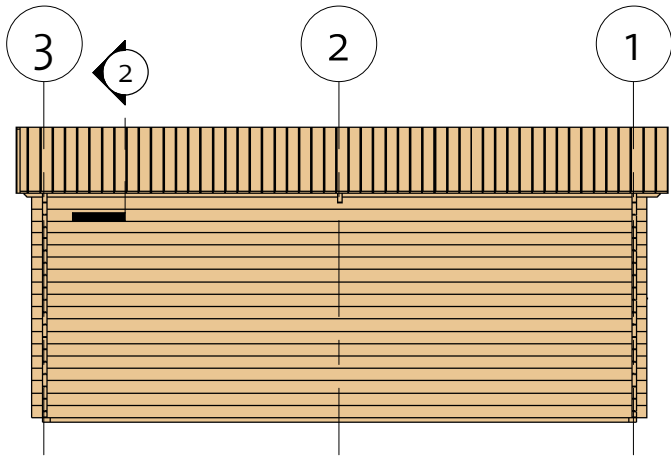

3 Roof Reinforcement

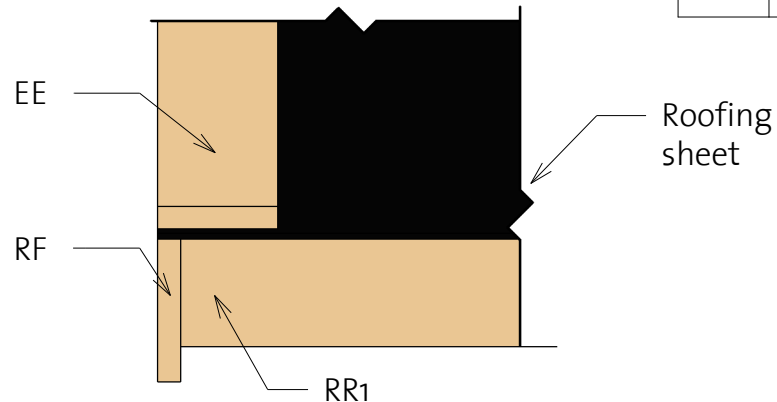

Fascia Schedule				
Mark	Type	Profile	Count	Length
EE	Eave Edging 18x95		4	105 1/8"
RF	Roof Fascia 18x120		4	105 1/8"
RR1	Roof reinforcement 18x95		2	234 1/4"
RR2	Roof reinforcement 38x38		2	234 1/4"

# Garage B 40 (177 1/8" x 216 1/2")

Extras

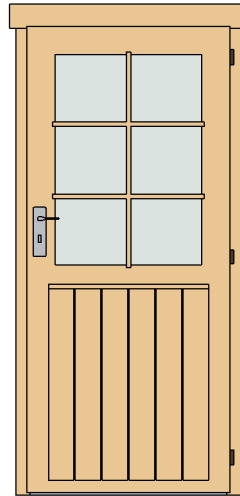
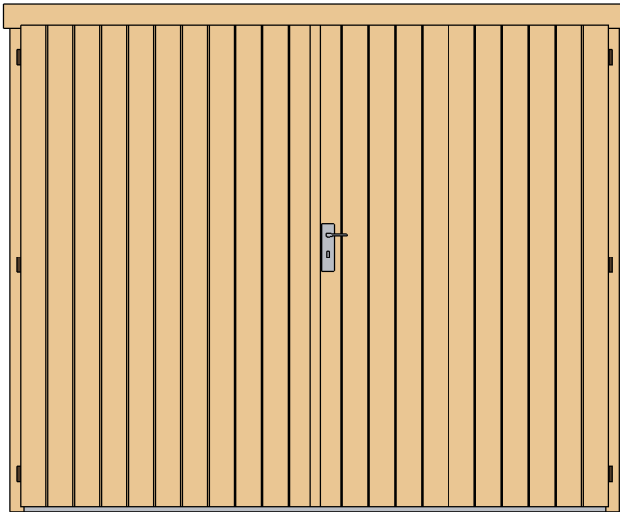

Door Schedule				
Mark	Type	Width	Height	Count
CD1R	Classic door 1 right	33 1/8"	74 3/8"	1
CDD1oR	Classic double door 1o, wood right	93 1/4"	77"	1
DCB6	Door Crossbar 6	--	--	0"

Fasteners/Extras		
Name	Type	Count
Hitblock	300-400 mm	
Door Bolt	315 x 65	2
Bolts	M8 x 70	12
Screws	5,0 x 70	15
Screws	5,0 x 40	16
Screws	6,0 x 140	60
Screws	4,0 x 40	590

Type	Count	Length
Windboard 18x40	4	86 5/8"

Family	Count
--------	-------

Romb	2
------	---

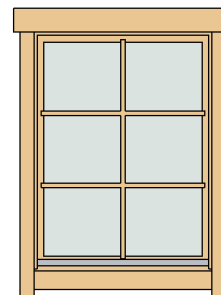



Window Schedule				
Mark	Type	Width	Height	Count
CW1R	Classic window 1 right	30 1/8"	39"	1
WCB6	Window Crossbar 6	--	--	0"

4400003\_230505



# Garage B 40 (177 1/8"x216 1/2")

## List of all items 1





Impregnated foundation beams				
Mark	Type	Profile	Count	Length

IFB1	IFB 70x40		2	176 3/4"
IFB2	IFB 70x40		2	211"

Roof				
Mark	Type	Profile	Count	Length

RFR	Ridge 40x143		1	234 1/4"
RFB	Beam 40x143		4	234 1/4"
RB	17x114		108	103 5/8"

Fascia Schedule				
Mark	Type	Profile	Count	Length

EE	Eave Edging 18x95		4	105 1/8"
RF	Roof Fascia 18x120		4	105 1/8"
RR1	Roof reinforcement 18x95		2	234 1/4"
RR2	Roof reinforcement 38x38		2	234 1/4"

# Garage B 40 (177 1/8"x216 1/2")

## List of all items 2

Wall 1			
Mark	Profile	Count	Cut Length

1BL 1	40X57	2	45 5/8"
1LG 1 *	40X114	1	38 3/4"
1LG 2	40X114	34	45 5/8"
1LG 3 *	40X114	1	77 3/8"
1LG 4 *	40X114	1	116"
1LG 5 *	40X114	1	154 5/8"
1LG 6 *	40X114	1	185"
1LG 7	40X114	1	185"

Wall 3			
Mark	Profile	Count	Cut Length

3BL 1	40X57	1	185"
3LG 1 *	40X114	1	38 3/4"
3LG 2 *	40X114	1	77 3/8"
3LG 3 *	40X114	1	116"
3LG 4 *	40X114	1	154 5/8"
3LG 5 *	40X114	1	185"
3LG 6	40X114	18	185"

\*Gable-delivered premounted

Log Profiles	
Profile	Profile

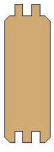
40X57	
40X114	

Wall 2			
Mark	Profile	Count	Cut Length

2LG 1 *	40X114	1	38 3/4"
2LG 2 *	40X114	1	77 3/8"
2LG 3 *	40X114	1	116"
2LG 4 *	40X114	1	154 5/8"
2LG 5 *	40X114	1	185"
2LG 6	40X114	1	185"

Wall A			
Mark	Profile	Count	Cut Length

ALG 1	40X114	17	224 3/8"
ALG 2	40X114	1	224 3/8"
ATL 1	40X114	1	234 1/4"

Wall B			
Mark	Profile	Count	Cut Length

BLG 1	40X114	8	154 3/4"
BLG 2	40X114	26	36 1/4"
BLG 3	40X114	9	88 1/4"
BLG 4	40X114	1	224 3/8"
BTL 1	40X114	1	234 1/4"

Log Profiles	
Profile	Profile

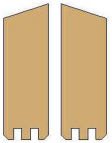
40X114	
--------	---