

Ontario Bunkie 40 (106 1/4"x141 3/4")

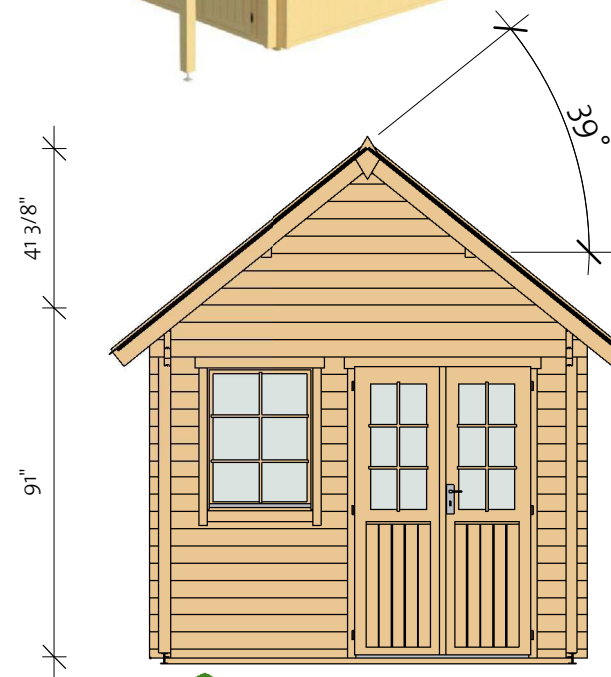

Ontario Bunkie 40 (106 1/4"x141 3/4")

Foundation

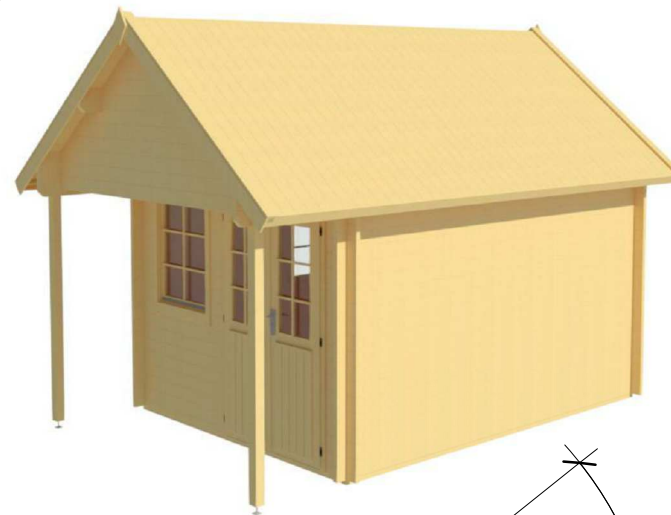
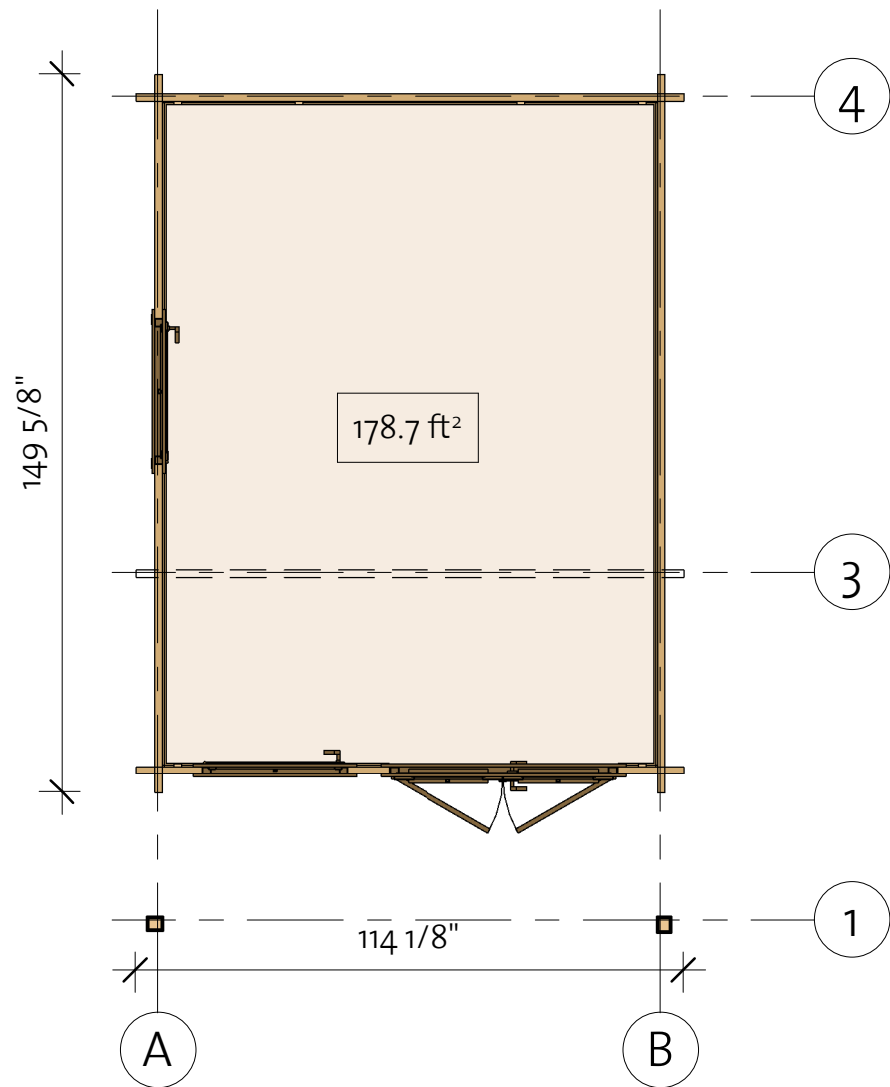
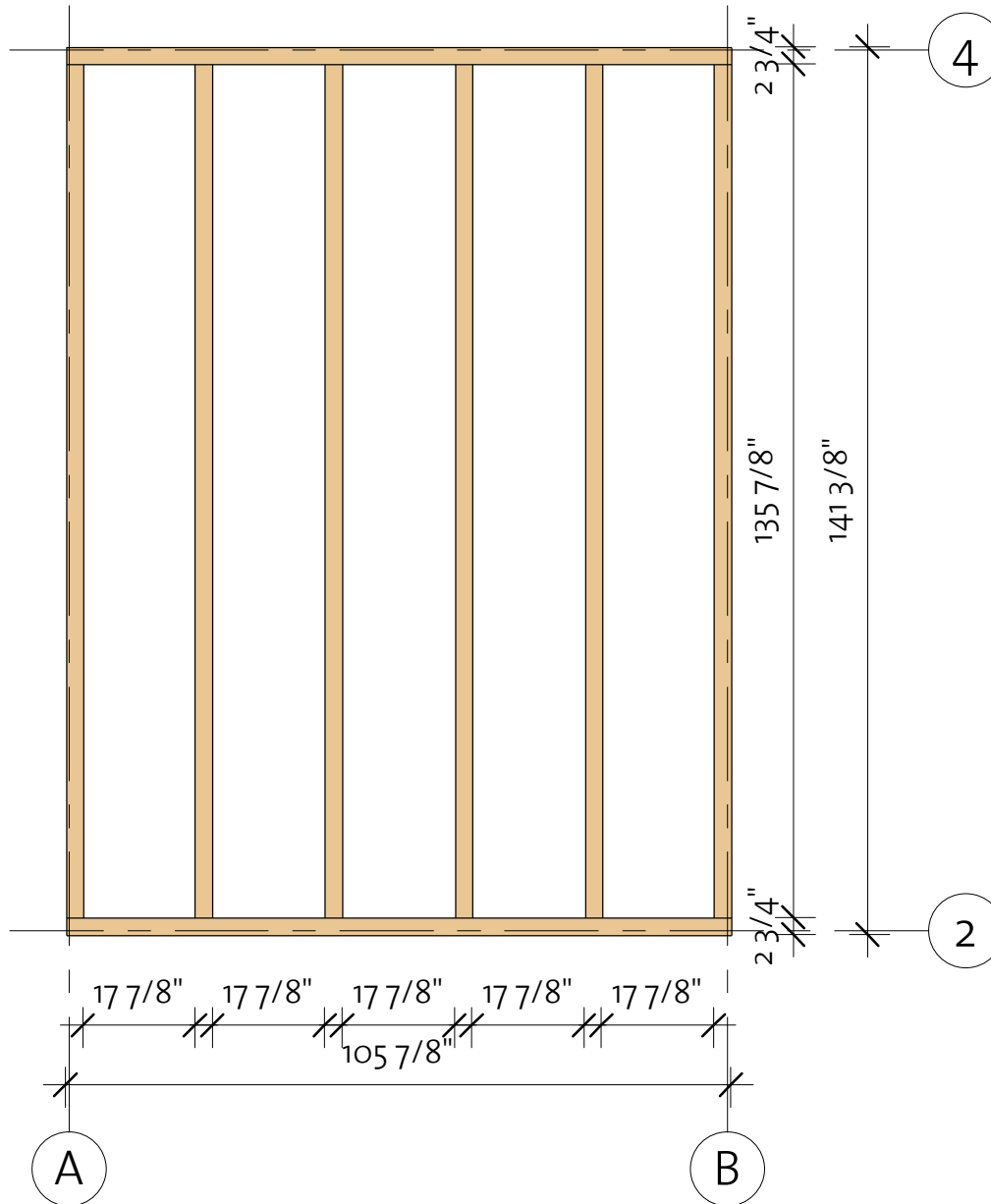

Impregnated foundation beams				
Mark	Type	Profile	Count	Length
IFB1	IFB 70x40		6	135 7/8"
IFB2	IFB 70x40		2	105 7/8"

Ontario Bunkie 40 (106 1/4"x141 3/4")

Floor Plan

① Baseboard

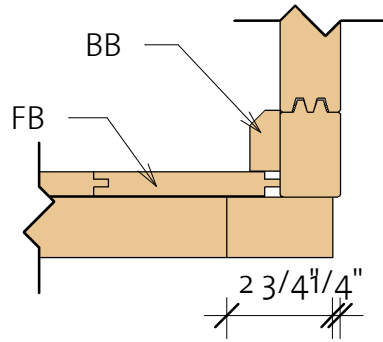

Floor Schedule				
Mark	Type	Profile	Count	Length
FB1	FB 17x114		32	103"
FB2	FB 17x114		24	72 7/8"
BB	BB 20x40		5	149 5/8"

4200002_200811

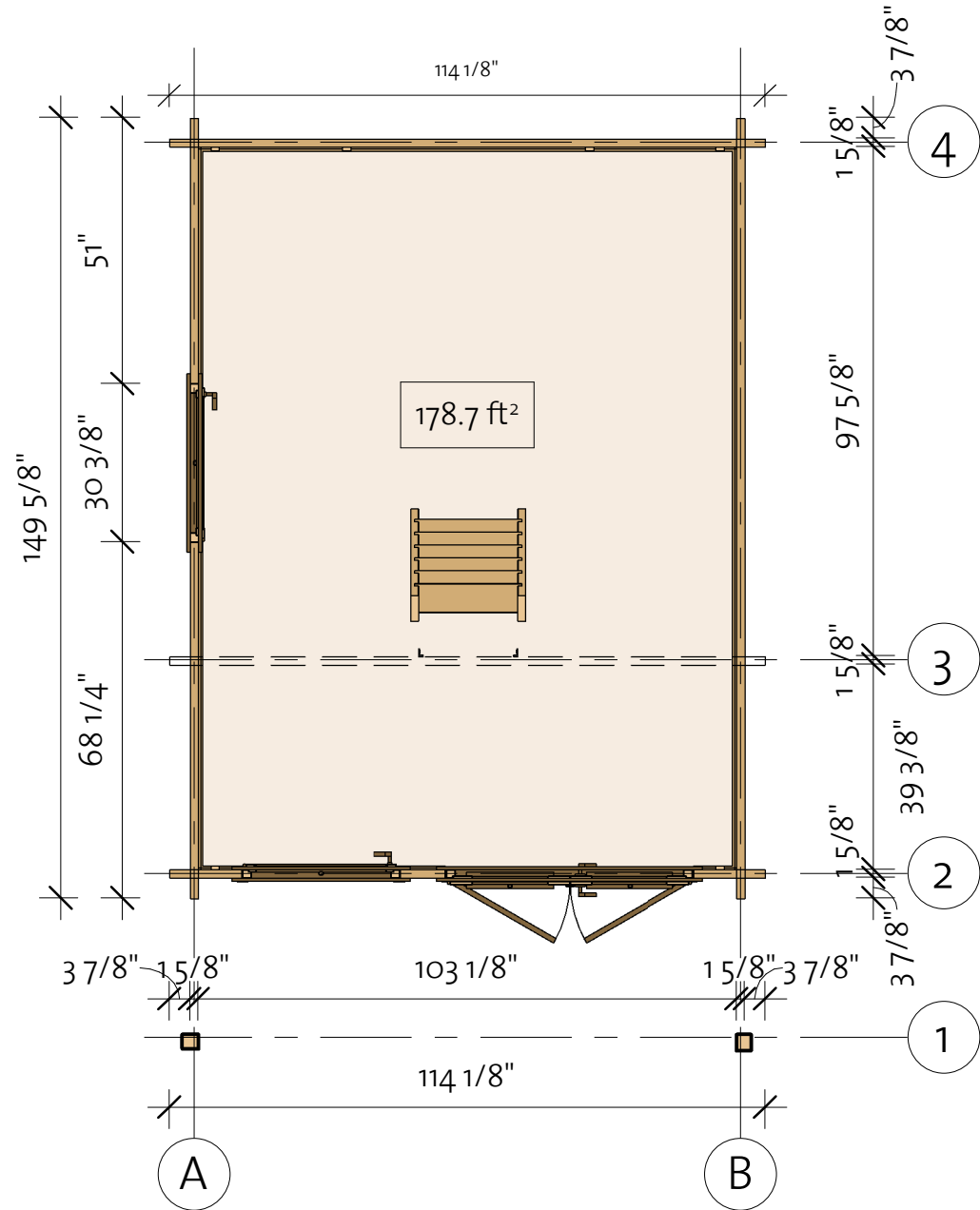

Ontario Bunkie 40 (106 1/4"x141 3/4")

Wall 1

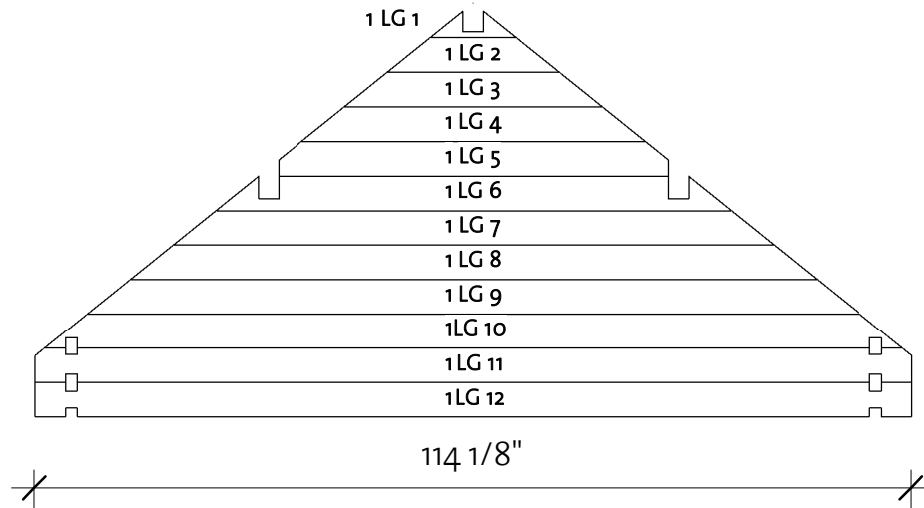
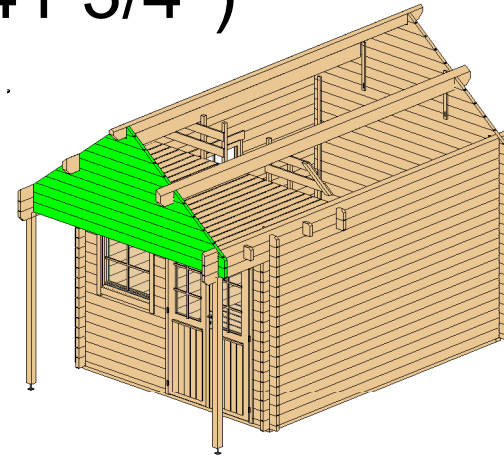

Wall 1			
Mark	Profile	Count	Cut Length

1LG 1 *	40X114	1	11 1/4"
1LG 2 *	40X114	1	22 3/8"
1LG 3 *	40X114	1	33 1/2"
1LG 4 *	40X114	1	44 3/4"
1LG 5 *	40X114	1	50 5/8"
1LG 6 *	40X114	1	67 1/8"
1LG 7 *	40X114	1	78 1/4"
1LG 8 *	40X114	1	89 3/8"
1LG 9 *	40X114	1	100 5/8"
1LG 10 *	40X114	1	111 3/4"
1LG 11 *	40X114	1	114 1/8"
1LG 12	40X114	1	114 1/8"

* Gable - delivered premounted

Log Profile Wall 1	
Profile	Profile

40X114	
--------	--

Ontario Bunkie 40 (106 1/4"x141 3/4")

Wall 2

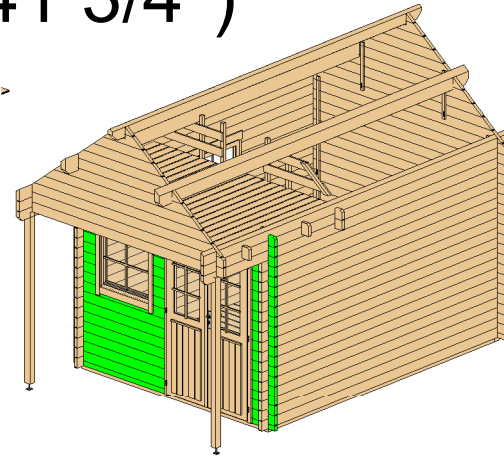

Wall 2			
Mark	Profile	Count	Cut Length

2BL 1	40X57	1	13 3/4"
2BL 2	40X57	1	52 3/4"
2LG 1	40X114	9	8 5/8"
2LG 2	40X114	26	13 3/4"
2LG 3	40X114	8	52 3/4"
2LG 4	40X114	1	114 1/8"
2LG 5	40X114	1	114 1/8"

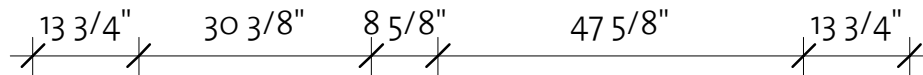
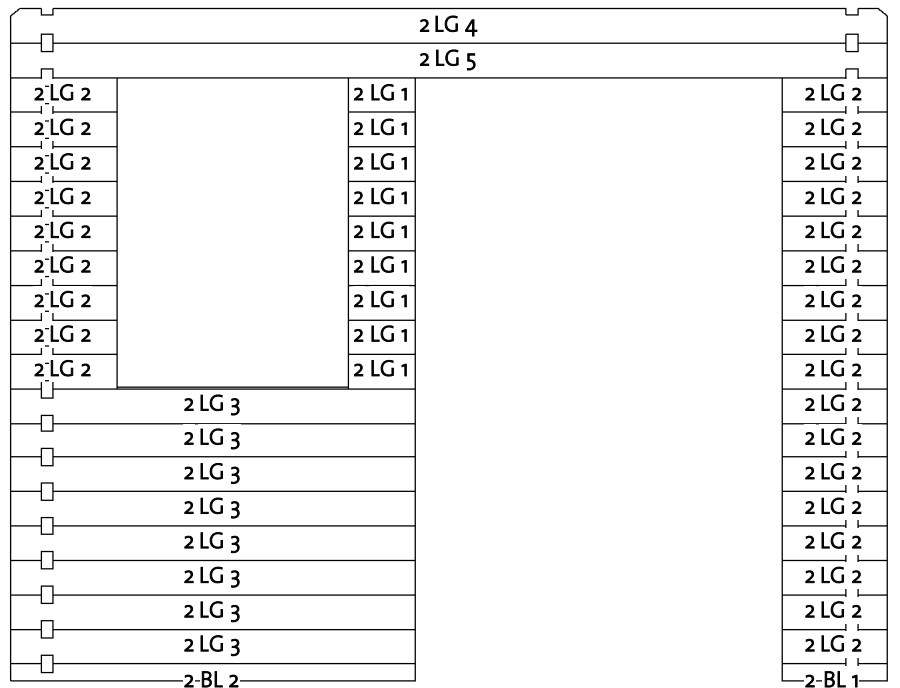

Log Profile Wall 2	
Profile	Images4

40X57	
40X114	
40X114	

Ontario Bunkie 40 (106 1/4"x141 3/4")

Wall 3

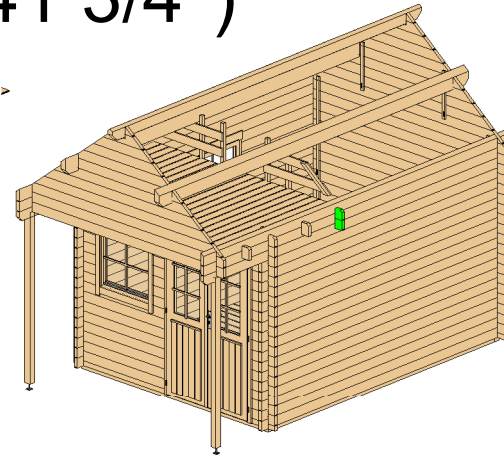

Wall 3			
Mark	Profile	Count	Cut Length

3LG 1	4OX114	1	114 1/8"
3LG 2	4OX114	1	114 1/8"

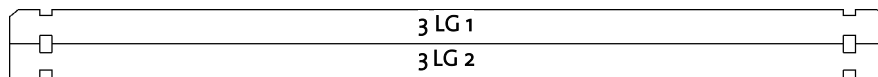

Log Profile Wall 3	
Profile	Images4

4OX114	
4OX114	

Ontario Bunkie 40 (106 1/4"x141 3/4")

Wall 4

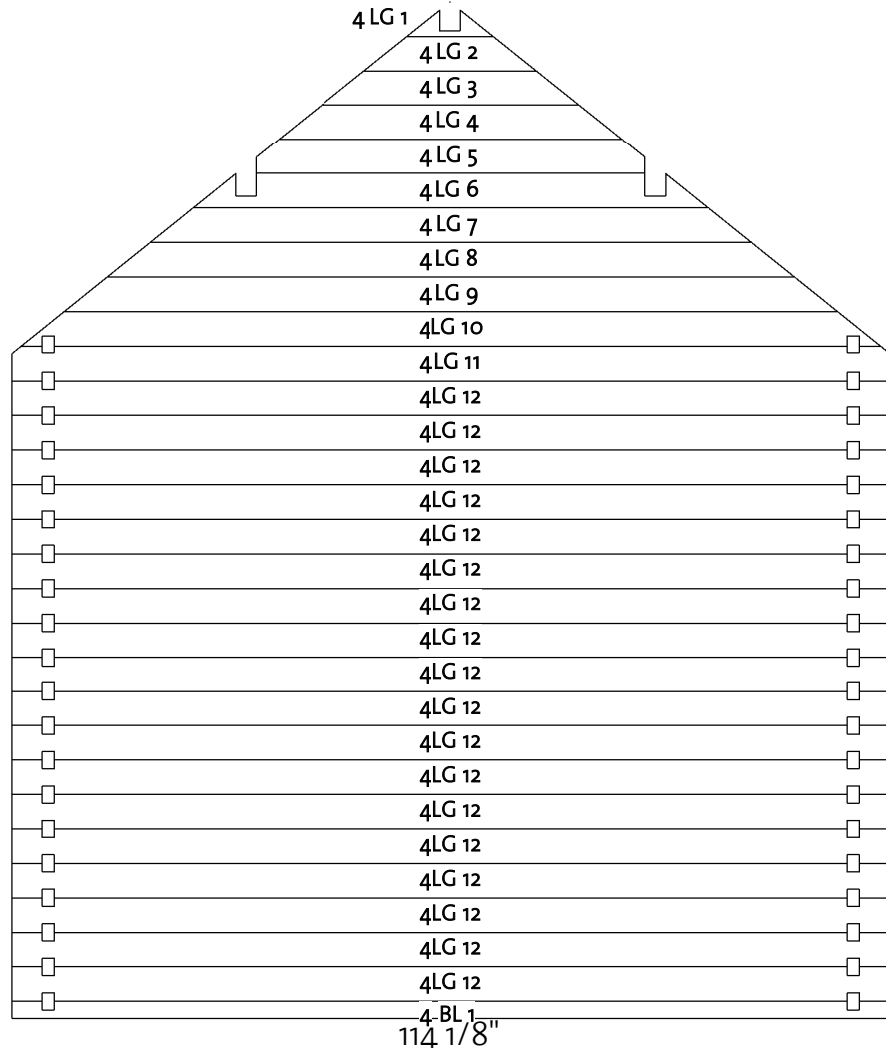
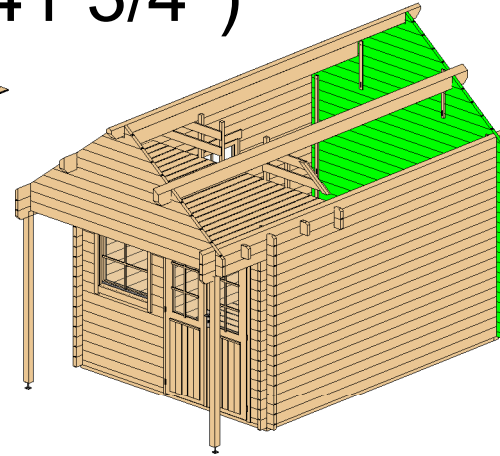

Wall 4			
Mark	Profile	Count	Cut Length

4BL 1	40X57	1	114 1/8"
4LG 1 *	40X114	1	11 1/4"
4LG 2 *	40X114	1	22 3/8"
4LG 3 *	40X114	1	33 1/2"
4LG 4 *	40X114	1	44 3/4"
4LG 5 *	40X114	1	50 5/8"
4LG 6 *	40X114	1	67 1/8"
4LG 7 *	40X114	1	78 1/4"
4LG 8 *	40X114	1	89 3/8"
4LG 9 *	40X114	1	100 5/8"
4LG 10 *	40X114	1	111 3/4"
4LG 11 *	40X114	1	114 1/8"
4LG 12	40X114	18	114 1/8"

* Gable - delivered premounted

Log Profile Wall 4	
Profile	Profile

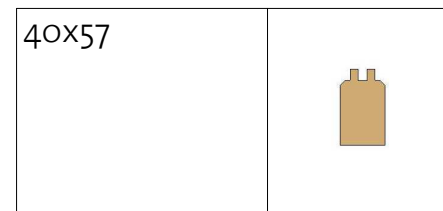

Log Profile Wall 4	
Profile	Profile

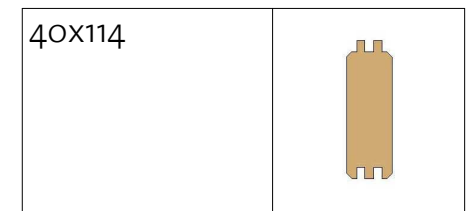

Ontario Bunkie 40 (106 1/4"x141 3/4")

Wall A

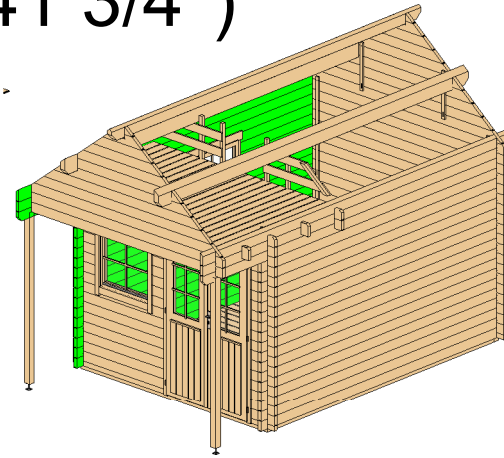

Wall A			
Mark	Profile	Count	Cut Length

ALG 1	40x114	9	51"
ALG 2	40x114	9	68 1/4"
ALG 3	40x114	8	149 5/8"
ALG 4	40x114	1	185"
ALG 5	40x114	1	189"
ATL 1	40x145	1	189"

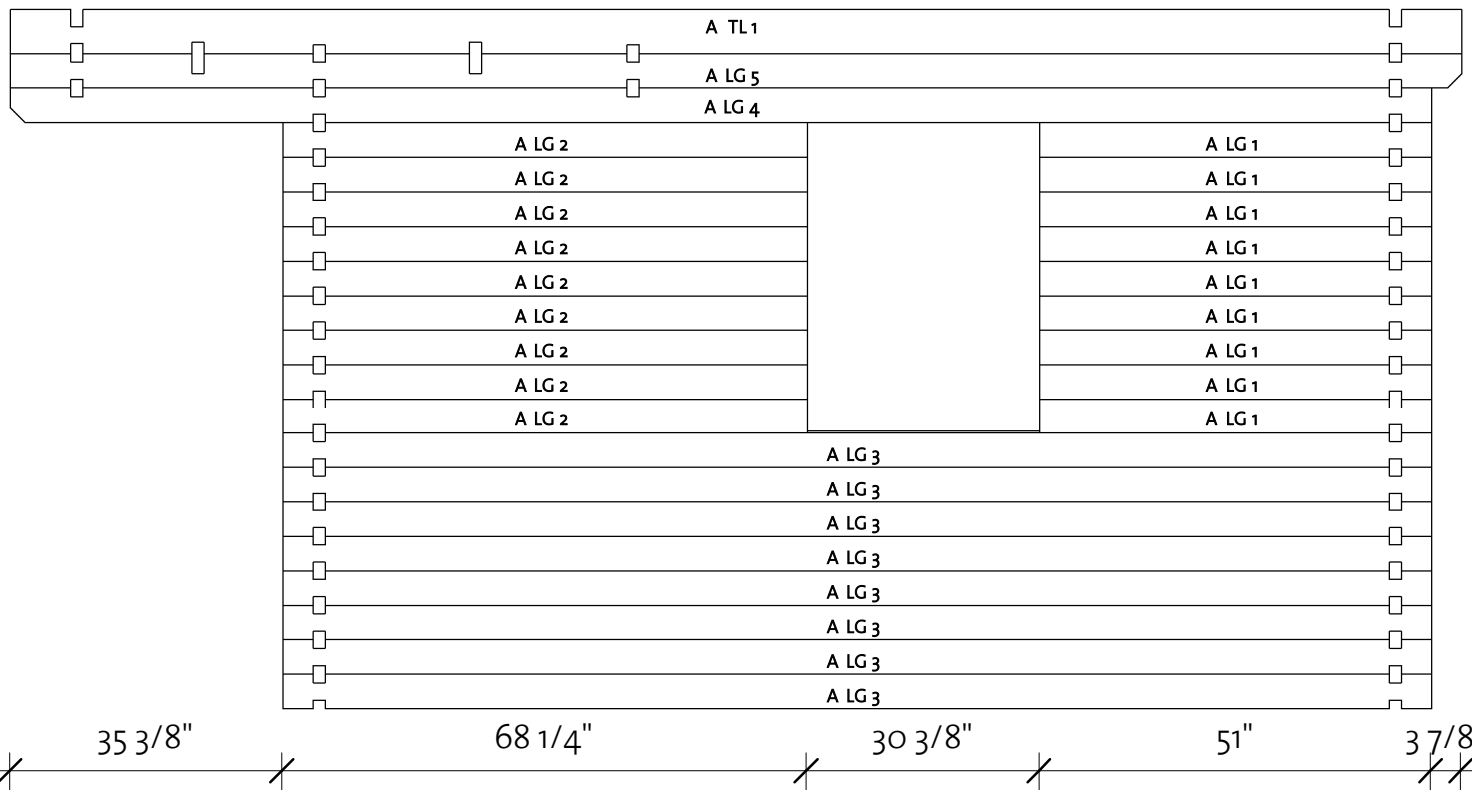

Log Profile Wall A	
Profile	Profile

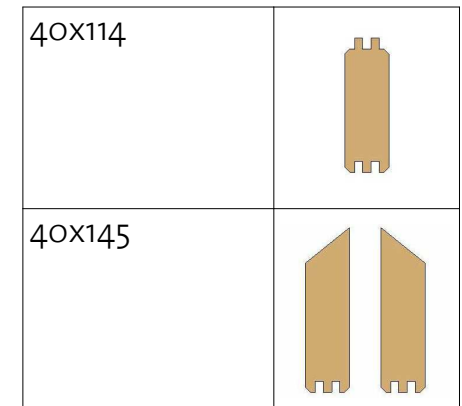

Ontario Bunkie 40 (106 1/4"x141 3/4")

Wall B

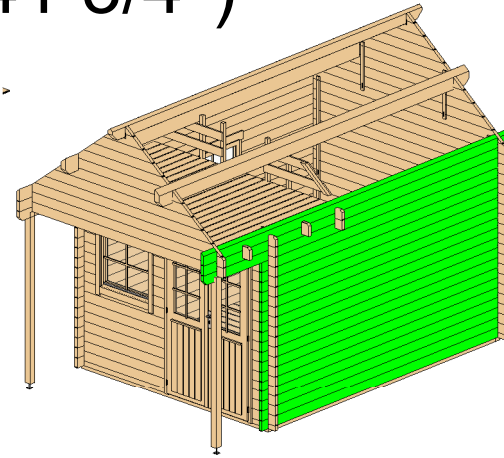

Wall B			
Mark	Profile	Count	Cut Length

BLG 1	40X114	17	149 5/8"
BLG 2	40X114	1	185"
BLG 3	40X114	1	189"
BTL 1	40X145	1	189"

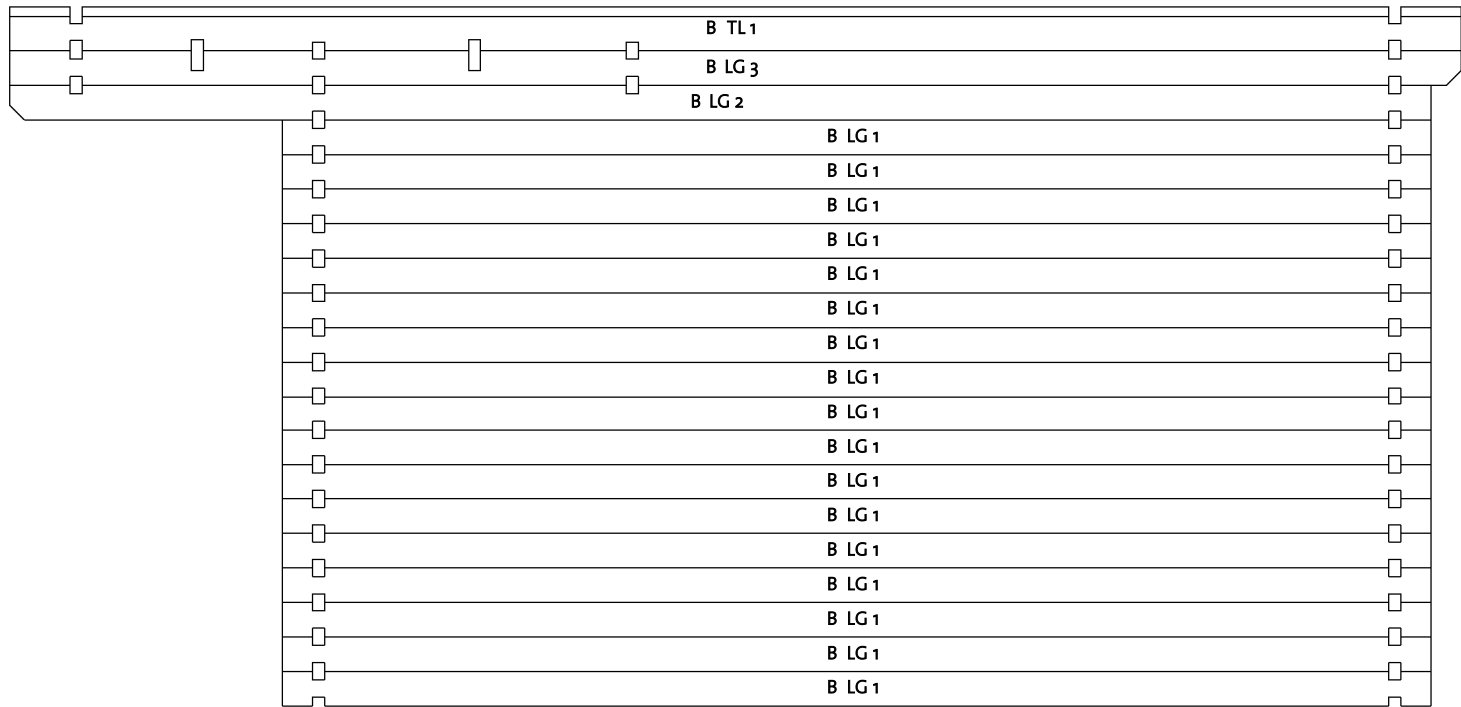

Log Profile Wall B	
Profile	Profile

40X114	
40X145	

Ontario Bunkie 40 (106 1/4"x141 3/4")

Second floor

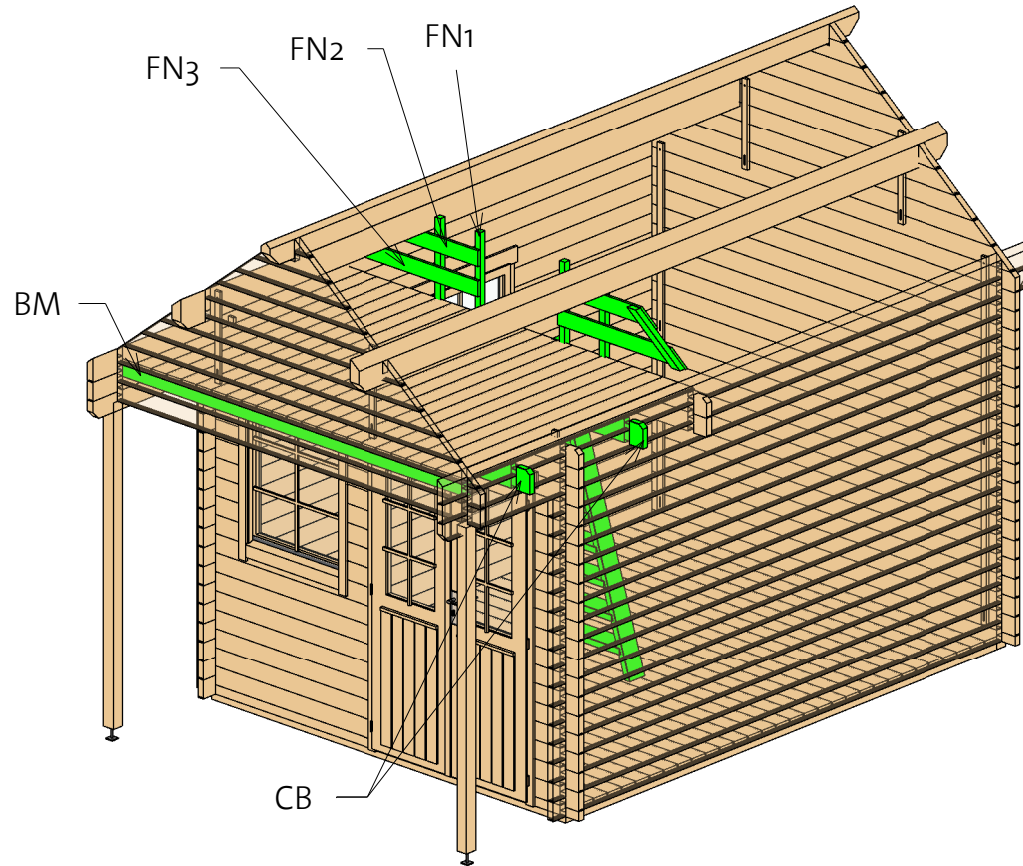

Second floor				
Mark	Type	Profile	Count	Cut Length
FN3	Fence3 18x95		2	38 1/8"
BM	Beam 40x90		1	103 1/8"
CB	Ceiling beam 40x143		2	114 1/8"
FN1	Fence1 38x38		6	26 3/4"
FN2	Fence2 18x95		2	29 1/4"

Ontario Bunkie 40 (106 1/4"x141 3/4")

Fence

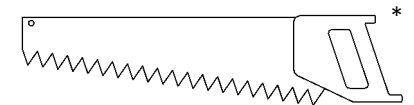
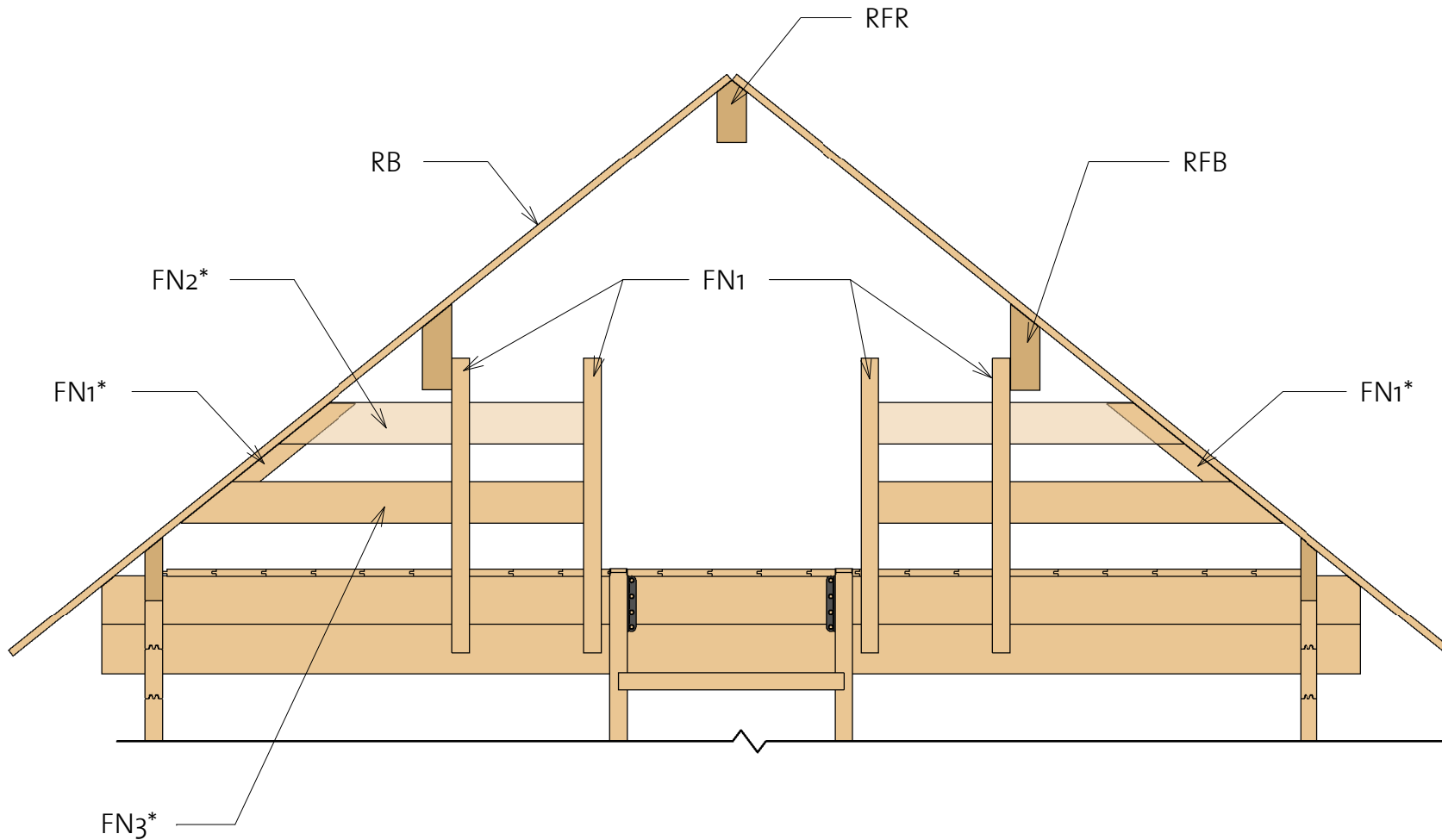

Ontario Bunkie 40 (106 1/4"x141 3/4")

Stair

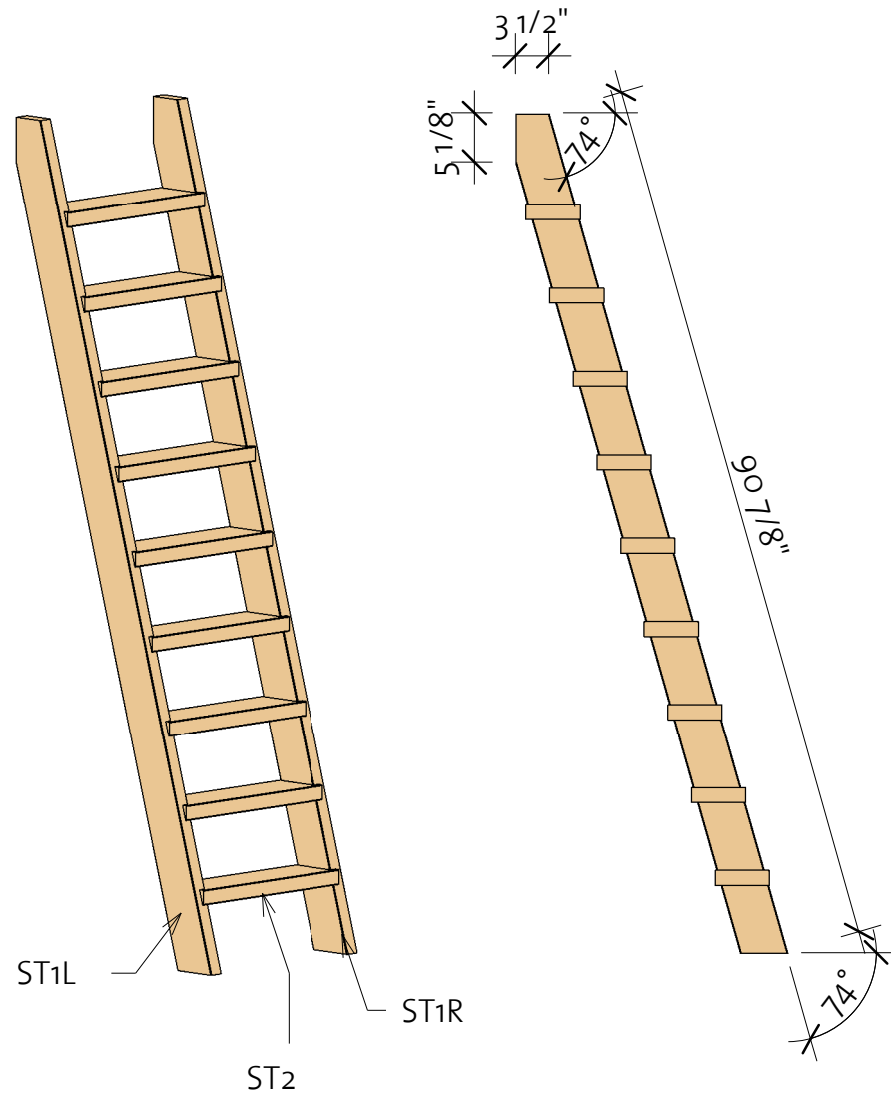

Stairs				
Mark	Profile	Profile	Count	Cut Length
ST1L	40X120		1	91 7/8"
ST1R	40X120		1	91 7/8"
ST2	143X40		9	20 1/2"

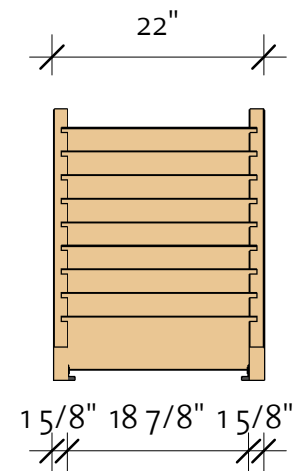

Ontario Bunkie 40 (106 1/4"x141 3/4")

Roof 1

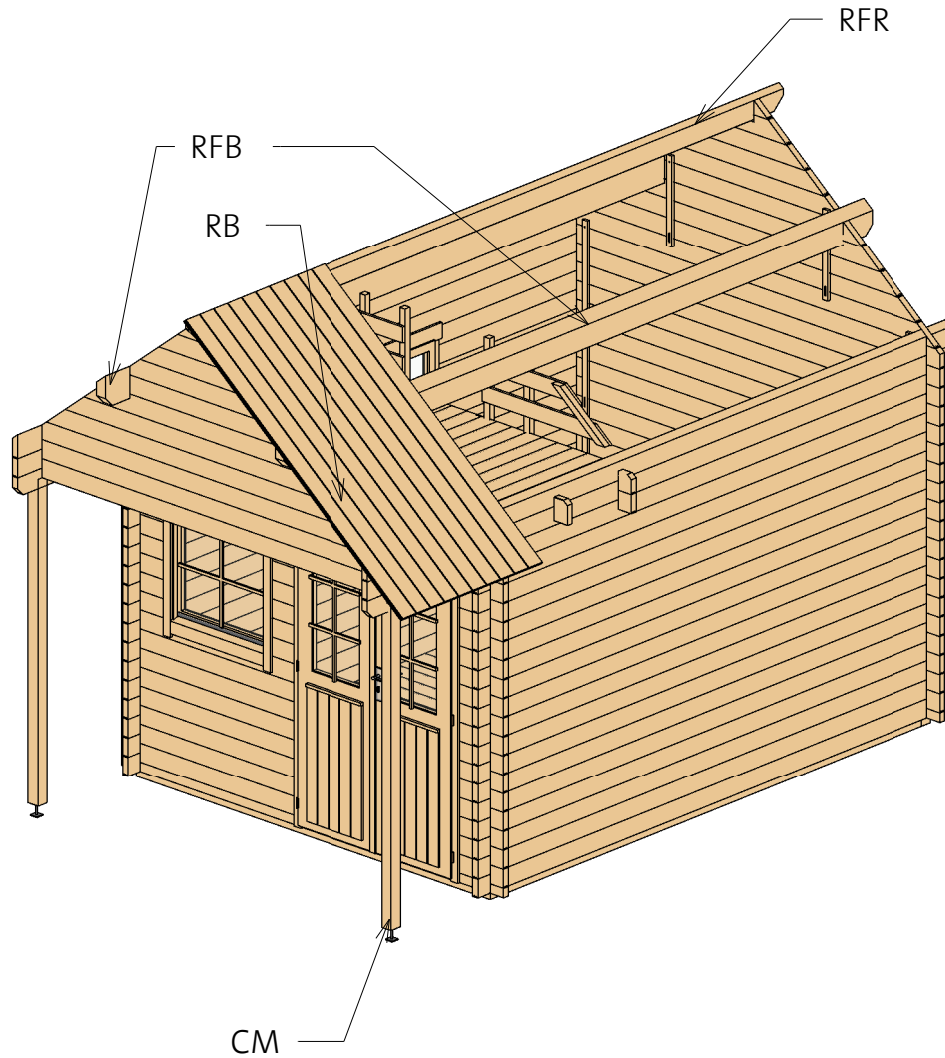

Roof				
Mark	Type	Profile	Count	Length
RFR	Ridge 68x143		1	189"
RFB	Beam 68x193		2	189"
RB	17x114		86	83 1/2"

Post			
Mark	Profile	Count	Length
CM	Post 80x70	2	77 1/8"

Ontario Bunkie 40 (106 1/4"x141 3/4")

Roof 2

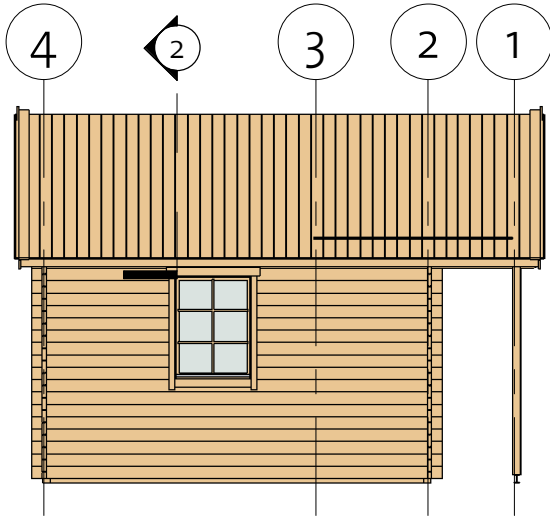

② Facia

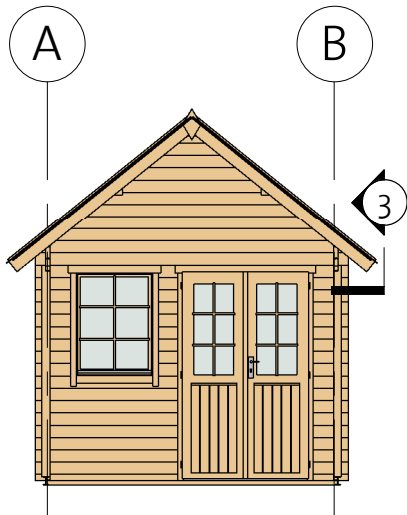
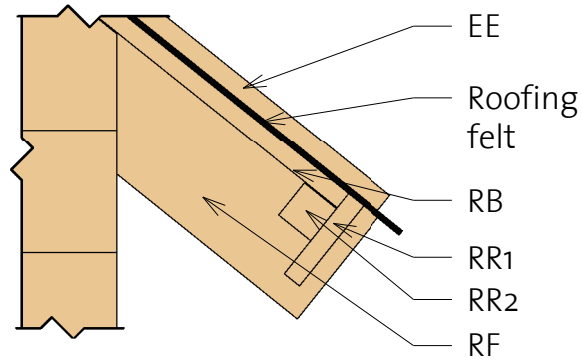

③ Roof Reinforcement

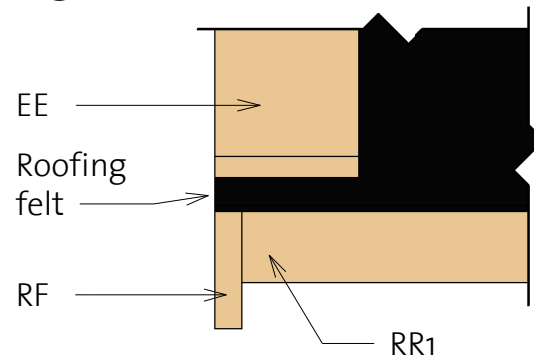

Fascia Schedule

Mark	Type	Profile	Count	Length
EE	Eave Edging 18x95		4	85 3/8"
RF	Roof Fascia 18x120		4	85 3/8"
RR1	Roof reinforcement 18x95		2	189"
RR2	Roof reinforcement 38x38		2	189"

Ontario Bunkie 40 (106 1/4"x141 3/4")

Extras

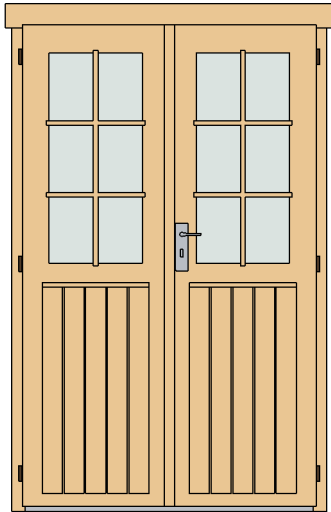

Door Schedule				
Model	Type	Width	Height	Count
CDD5R	Classic double door 5 right	47 1/4"	77"	1
DCB6-5	Door Crossbar 6-5	--	--	1/8"

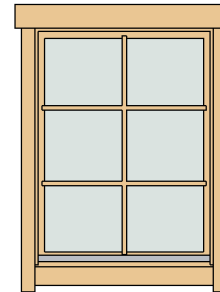

Window Schedule				
Model	Type	Width	Height	Count
CW1R	Classic window 1 right	30 1/8"	39"	2
WCB6	Windows Crossbar 6	--	--	2

Fasteners & Extras		
Name	Type	Count

Hitblock	300-400 mm	
Ladder fittings		2
Screws	6,0x160	6
Bolts	M8 x 70	20
Screws	5,0 x 70	45
Nails	1,4 x 40	50
Screws	6,0 x 140	80
Screws	4,0 x 40	820

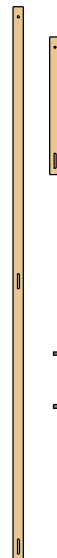

Type	Count	Length
Adjustable post foot	2	3"
Windboard1 18x40	4	86 5/8"
Windboard2 18x40	4	21 5/8"

Family	Count
Romb	2





4200002_200811

Ontario Bunkie 40 (106 1/4"x141 3/4")

List of all items 1

Impregnated foundation beams



Mark	Type	Profile	Count	Length
------	------	---------	-------	--------

IFB1	IFB 70x40		6	135 7/8"
IFB2	IFB 70x40		2	105 7/8"

BB	BB 20x40		5	149 5/8"
----	-------------	---	---	-------------



Floor Schedule

Mark	Type	Profile	Count	Length
------	------	---------	-------	--------

FB1	FB 17x114		32	103"
FB2	FB 17x114		24	72 7/8"



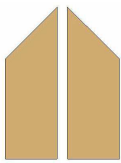

Roof

Mark	Type	Profile	Count	Length
------	------	---------	-------	--------

RFR	Ridge 68x143		1	189"
RFB	Beam 68x193		2	189"
RB	17x114		86	83 1/2"

Fascia Schedule

Mark	Type	Profile	Count	Length
------	------	---------	-------	--------

EE	Eave Edging 18x95		4	85 3/8"
RF	Roof Fascia 18x120		4	85 3/8"
RR1	Roof reinforcement 18x95		2	189"
RR2	Roof reinforcement 38x38		2	189"

Ontario Bunkie 40 (106 1/4"x141 3/4")

List of all items 2

Wall 1			
Mark	Profile	Count	Cut Length

1LG 1 *	40X114	1	11 1/4"
1LG 2 *	40X114	1	22 3/8"
1LG 3 *	40X114	1	33 1/2"
1LG 4 *	40X114	1	44 3/4"
1LG 5 *	40X114	1	50 5/8"
1LG 6 *	40X114	1	67 1/8"
1LG 7 *	40X114	1	78 1/4"
1LG 8 *	40X114	1	89 3/8"
1LG 9 *	40X114	1	100 5/8"
1LG 10 *	40X114	1	111 3/4"
1LG 11 *	40X114	1	114 1/8"
1LG 12	40X114	1	114 1/8"

Wall 4			
Mark	Profile	Count	Cut Length

4BL 1	40X57	1	114 1/8"
4LG 1 *	40X114	1	11 1/4"
4LG 2 *	40X114	1	22 3/8"
4LG 3 *	40X114	1	33 1/2"
4LG 4 *	40X114	1	44 3/4"
4LG 5 *	40X114	1	50 5/8"
4LG 6 *	40X114	1	67 1/8"
4LG 7 *	40X114	1	78 1/4"
4LG 8 *	40X114	1	89 3/8"
4LG 9 *	40X114	1	100 5/8"
4LG 10 *	40X114	1	111 3/4"
4LG 11 *	40X114	1	114 1/8"
4LG 12	40X114	18	114 1/8"

Wall 2			
Mark	Profile	Count	Cut Length



2BL 1	40X57	1	13 3/4"
2BL 2	40X57	1	52 3/4"
2LG 1	40X114	9	8 5/8"
2LG 2	40X114	26	13 3/4"
2LG 3	40X114	8	52 3/4"
2LG 4	40X114	1	114 1/8"
2LG 5	40X114	1	114 1/8"

Wall 3			
Mark	Profile	Count	Cut Length

3LG 1	40X114	1	114 1/8"
3LG 2	40X114	1	114 1/8"

*Gable-delivered premounted

Log Profiles 1	
Profile	Profile

40X57	
40X114	
40X114	

Ontario Bunkie 40 (106 1/4"x141 3/4")

List of all items 3

Wall A			
Mark	Profile	Count	Cut Length

ALG 1	40X114	9	51"
ALG 2	40X114	9	68 1/4"
ALG 3	40X114	8	149 5/8"
ALG 4	40X114	1	185"
ALG 5	40X114	1	189"
ATL 1	40X145	1	189"

Wall B			
Mark	Profile	Count	Cut Length





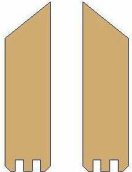



BLG 1	40X114	17	149 5/8"
BLG 2	40X114	1	185"
BLG 3	40X114	1	189"
BTL 1	40X145	1	189"

Log Profiles 2	
Profile	Profile

40X114	
40X145	

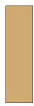
Ontario Bunkie 40 (106 1/4"x141 3/4")

List of all items 4

Second floor					Stairs				
Mark	Type	Profile	Count	Cut Length	Mark	Profile	Profile	Count	Cut Length
FN3	Fence3 18x95		2	38 1/8"	ST1L	40x120		1	91 7/8"
BM	Beam 40x90		1	103 1/8"	ST1R	40x120		1	91 7/8"
CB	Ceiling beam 40x143		2	114 1/8"	ST2	143x40		9	20 1/2"
FN1	Fence1 38x38		6	26 3/4"					
FN2	Fence2 18x95		2	29 1/4"					

Post			
Mark	Profile	Count	Length
CM	Post 80x70	2	77 1/8"